

CARRON COMPANY

Nº 2.

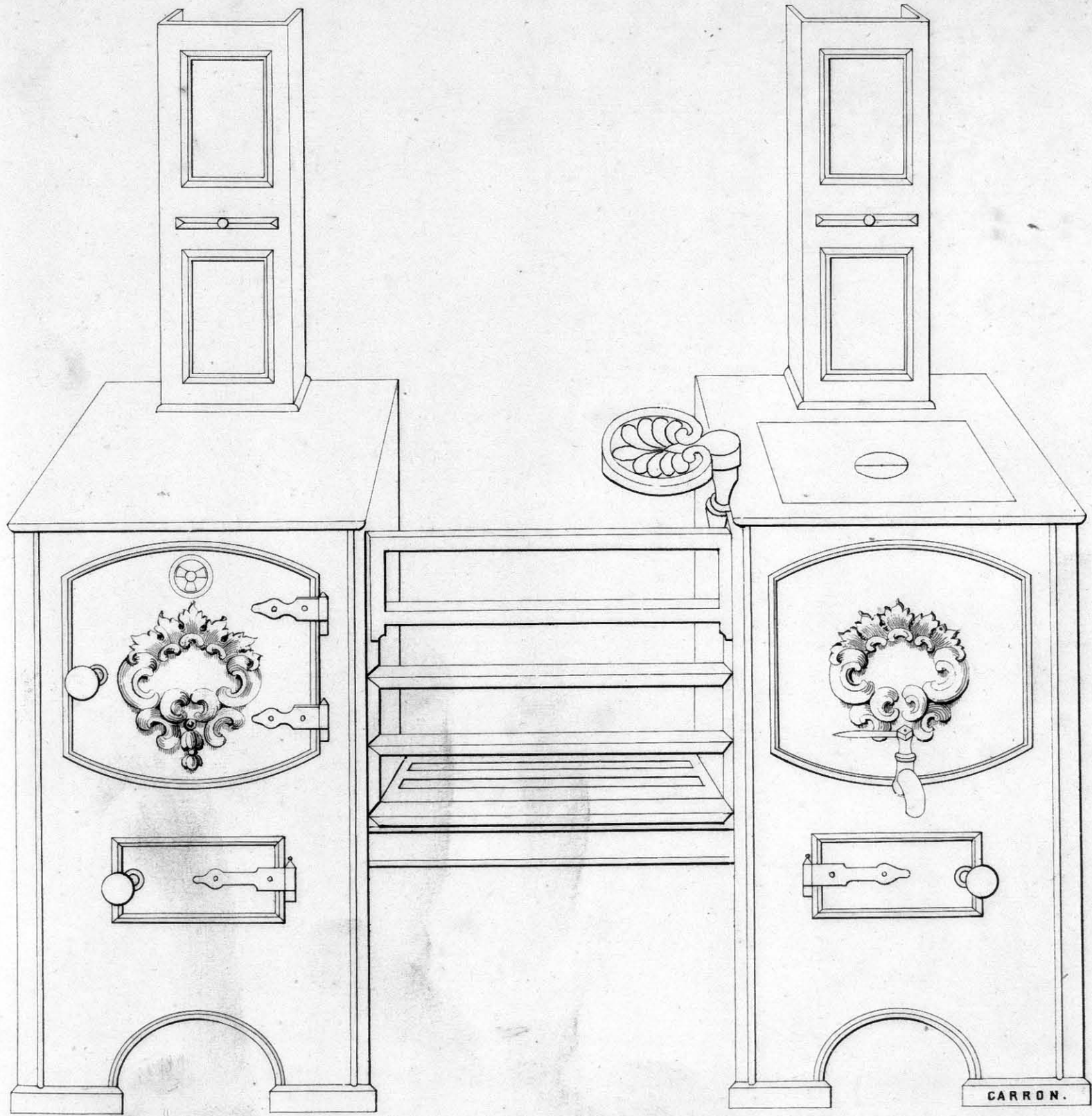

G Range with Oven and Boiler, with wrought or cast iron Bars, & with or without Back.

Sizes 36 to 54 inches wide by 24 inches high.

A small Front & Hob can be used instead of either Oven or Boiler. See Plate 00. Sizes 28 to 50 inches

S. Range No. 2.

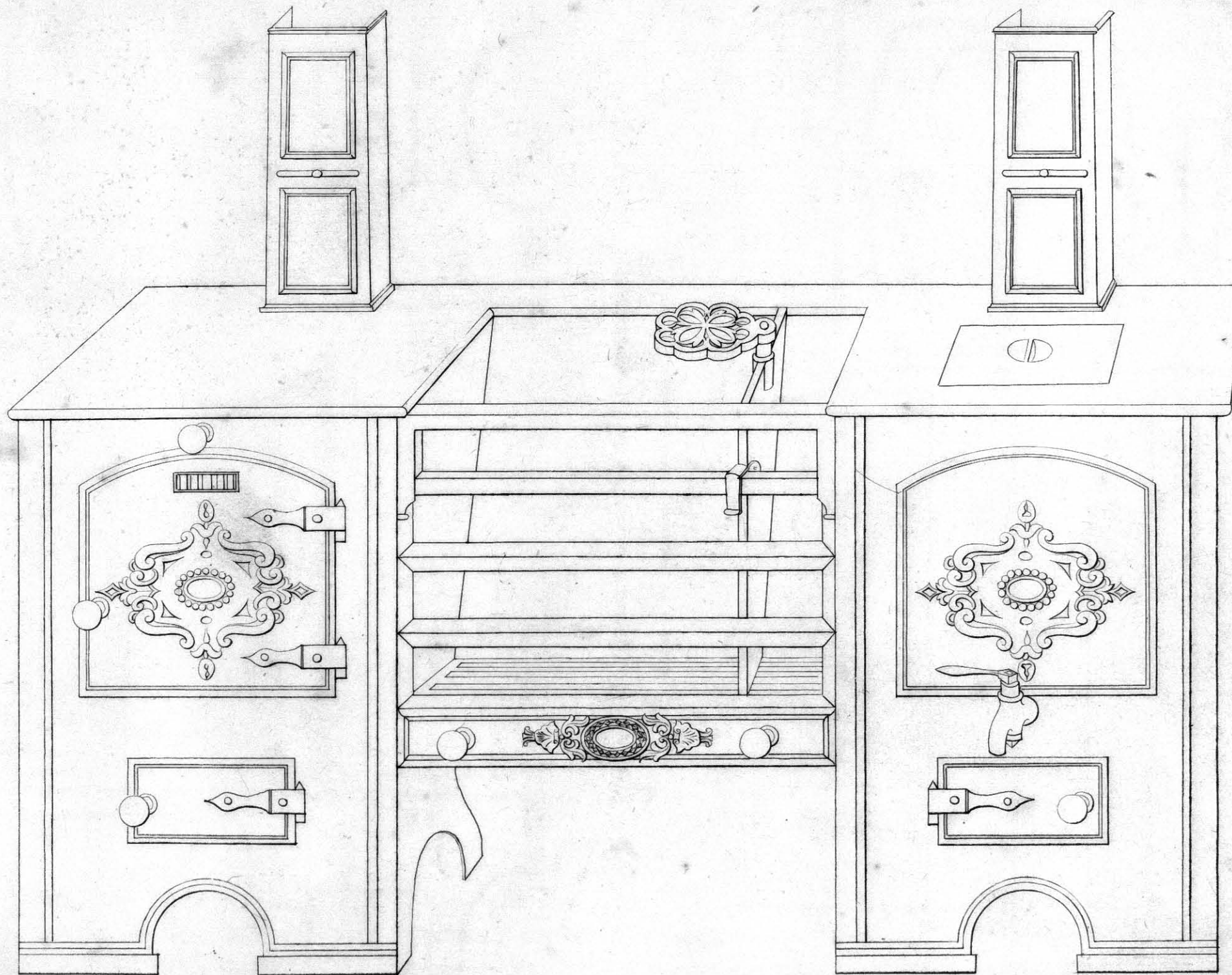

*With Oven and Boiler, Sizes 36 ins to 54 ins wide by 24 ins high
With Oven only or Boiler only and Sham Side, 32 ins to 48 ins wide*

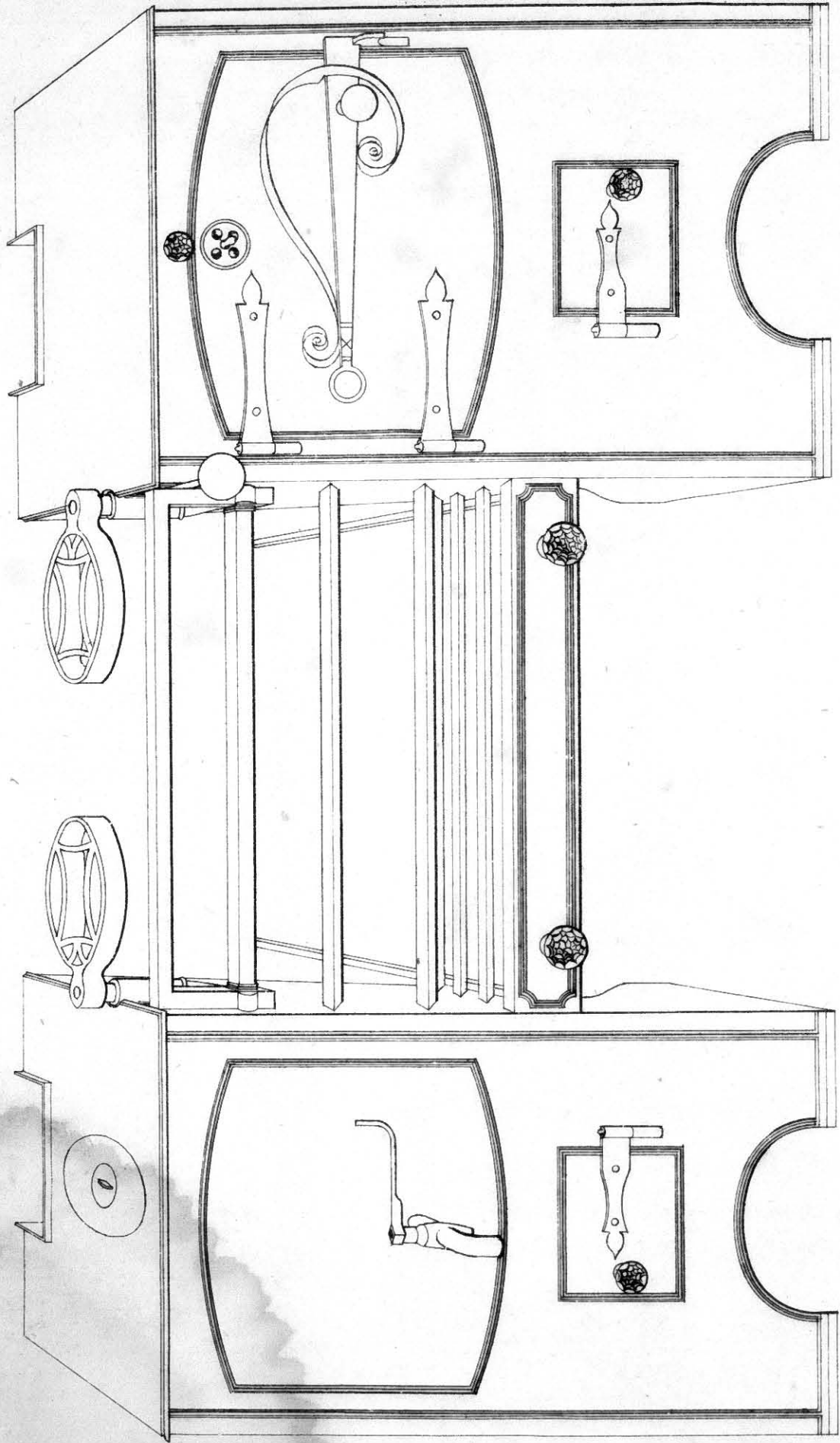

Range with Sussex oven, wrought Iron Bars, Square Boiler,

with or without Back,

Sizes 46 to 60 inches wide & 26 inches high.

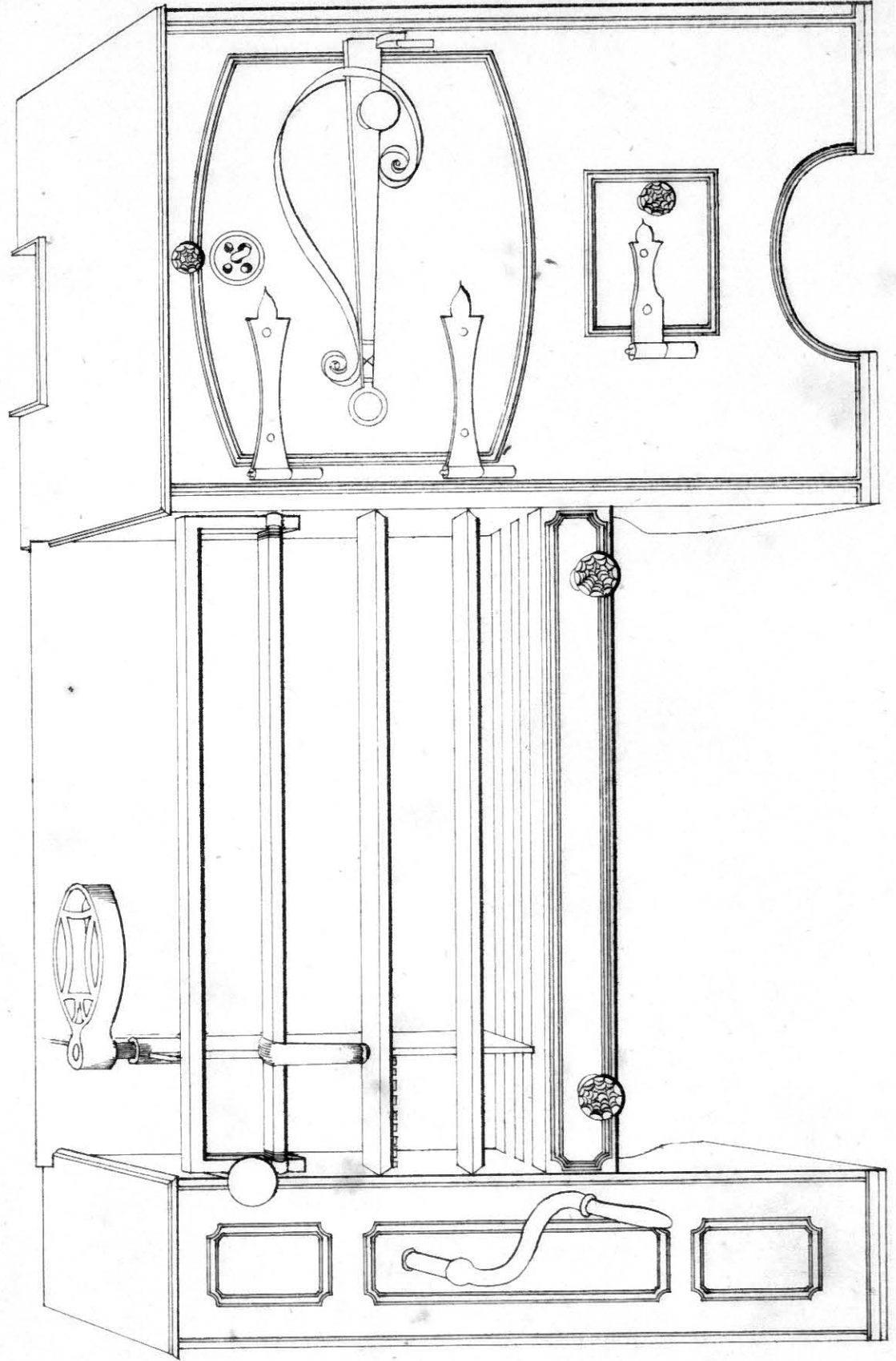

Range with Sussex Oven, wrought Iron Bars, Front & Hob,

with or without Back,

Sizes 36 to 60 inches wide & 26 inches high.

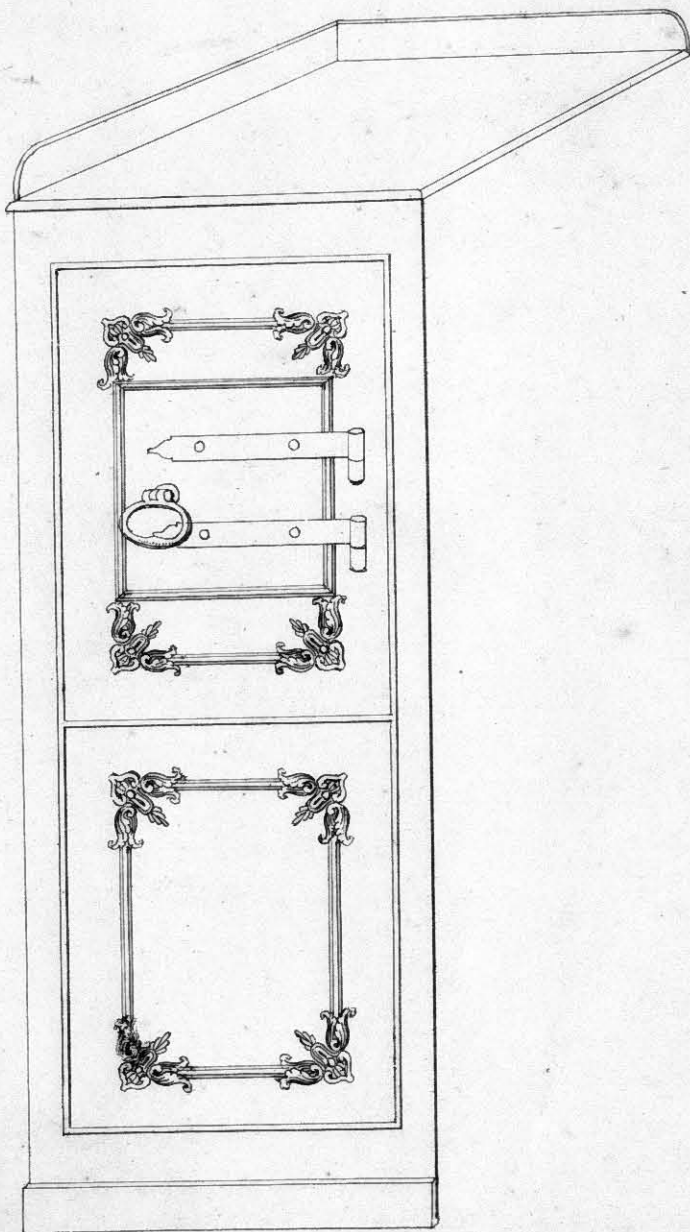

*Liverpool Square Oven
& Hot Hearth Range.*

38 to 48 Inches.

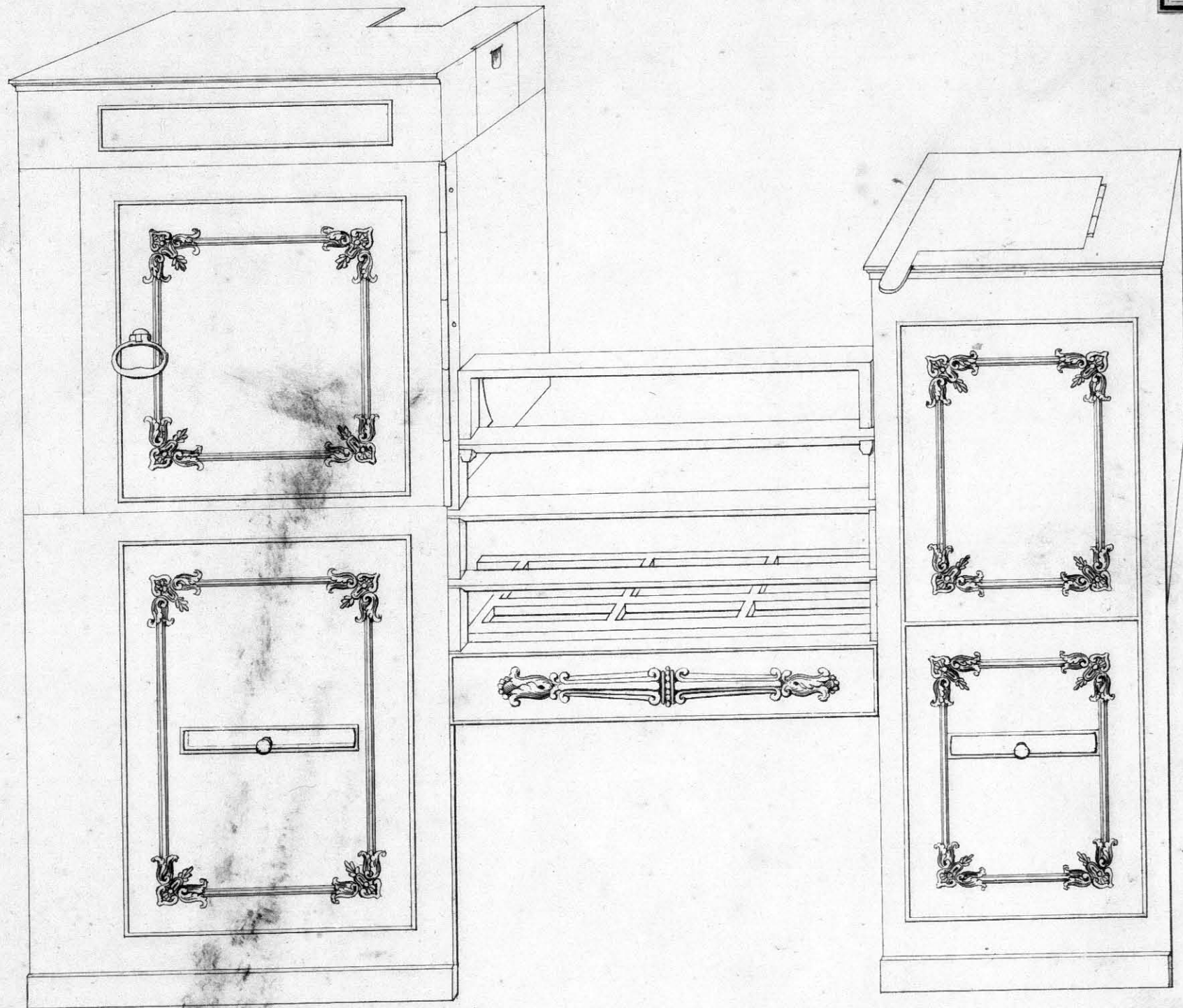

Liverpool Square Oven & Square Boiler Range.

38 to 60 Inches.

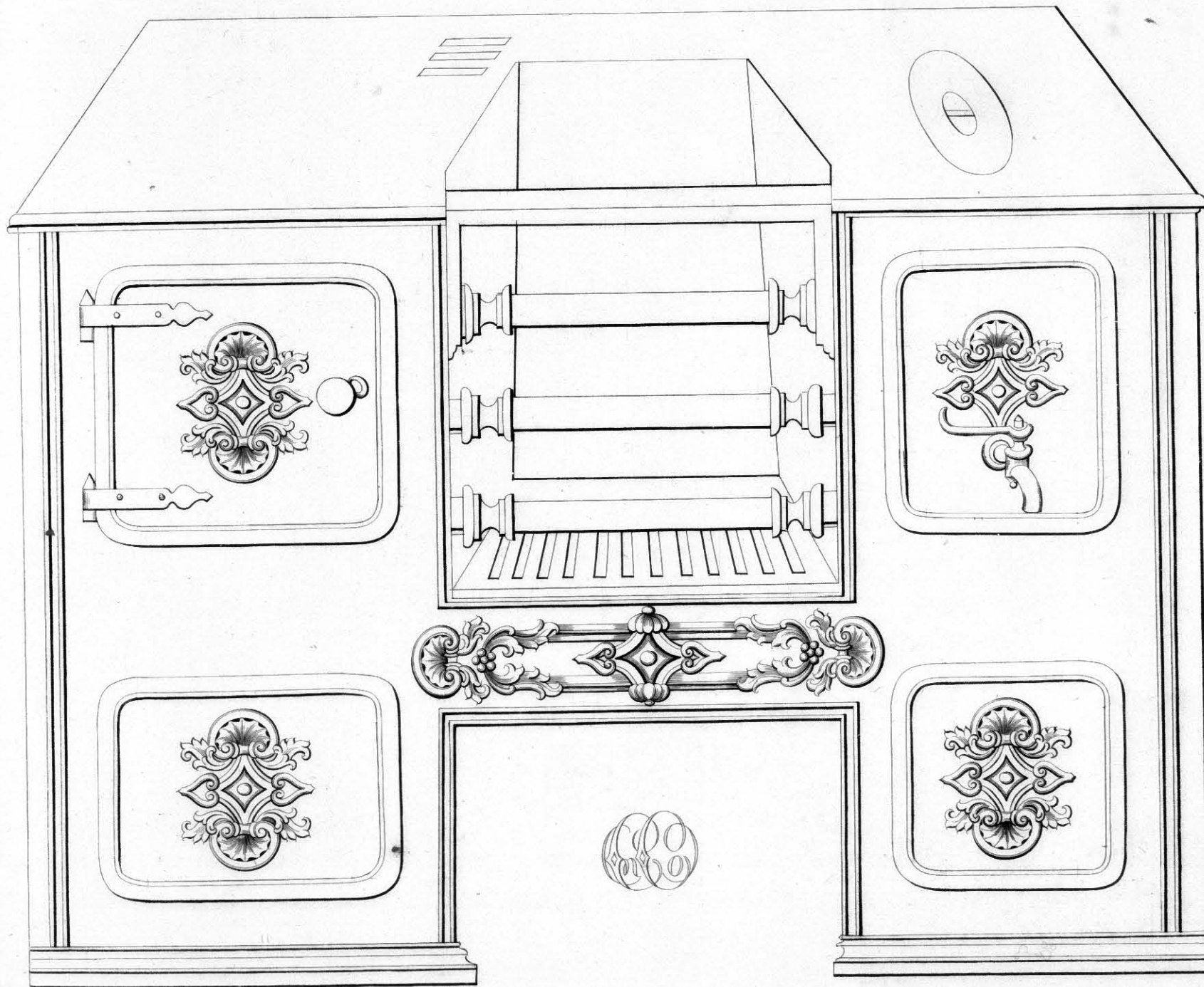

Kirkwood & Son. Edin.

SELF ACTING COTTAGE RANGE with Oven & Back Boiler.

Sizes 32-34-36 — 38-40-42 Inches

With 12 14 ins. Fires.

PLATE 6

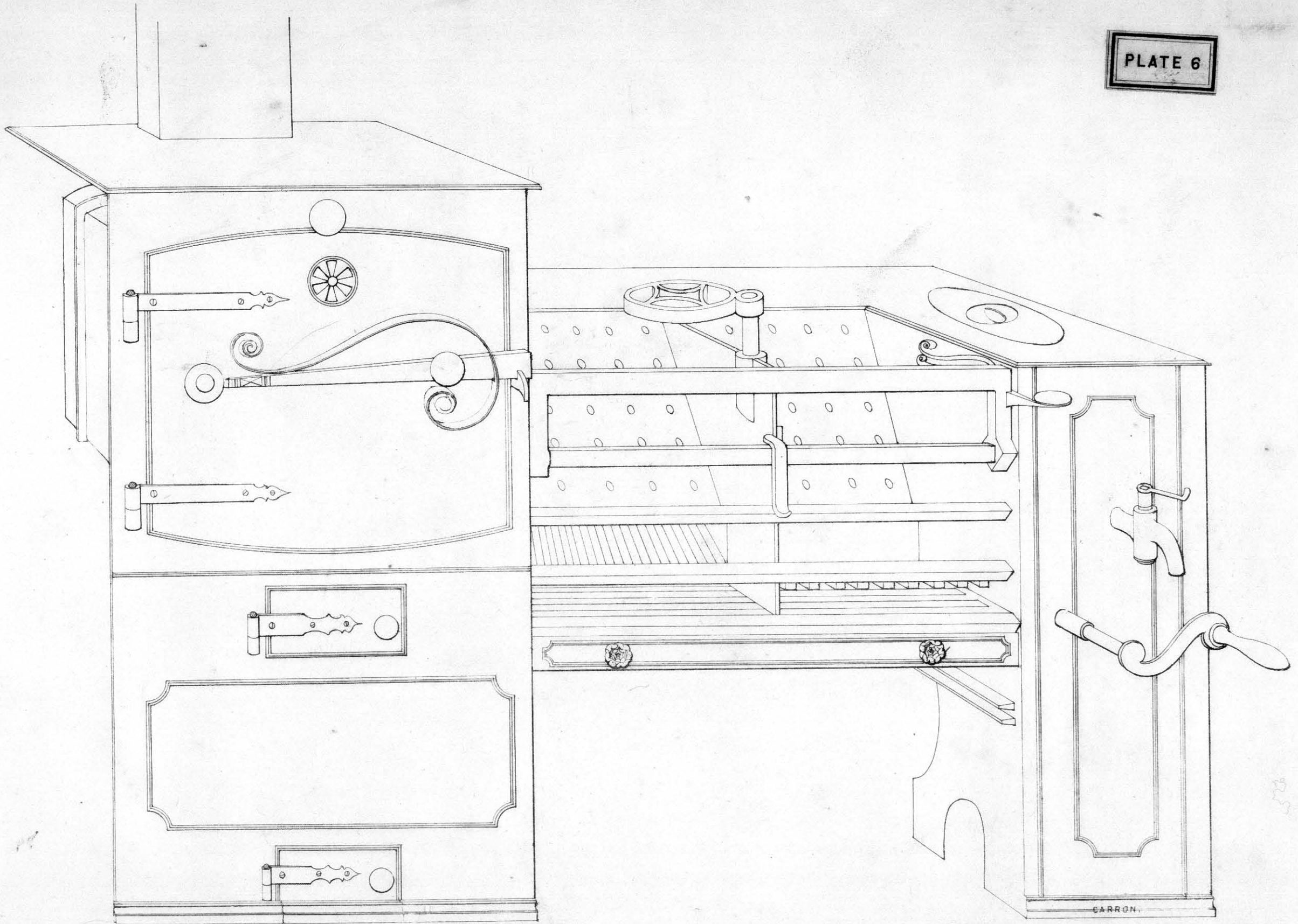

L Back Boiler Range, with Oven heated either from the Range or by a separate fire.

Sizes from 36 to 69 inches wide.

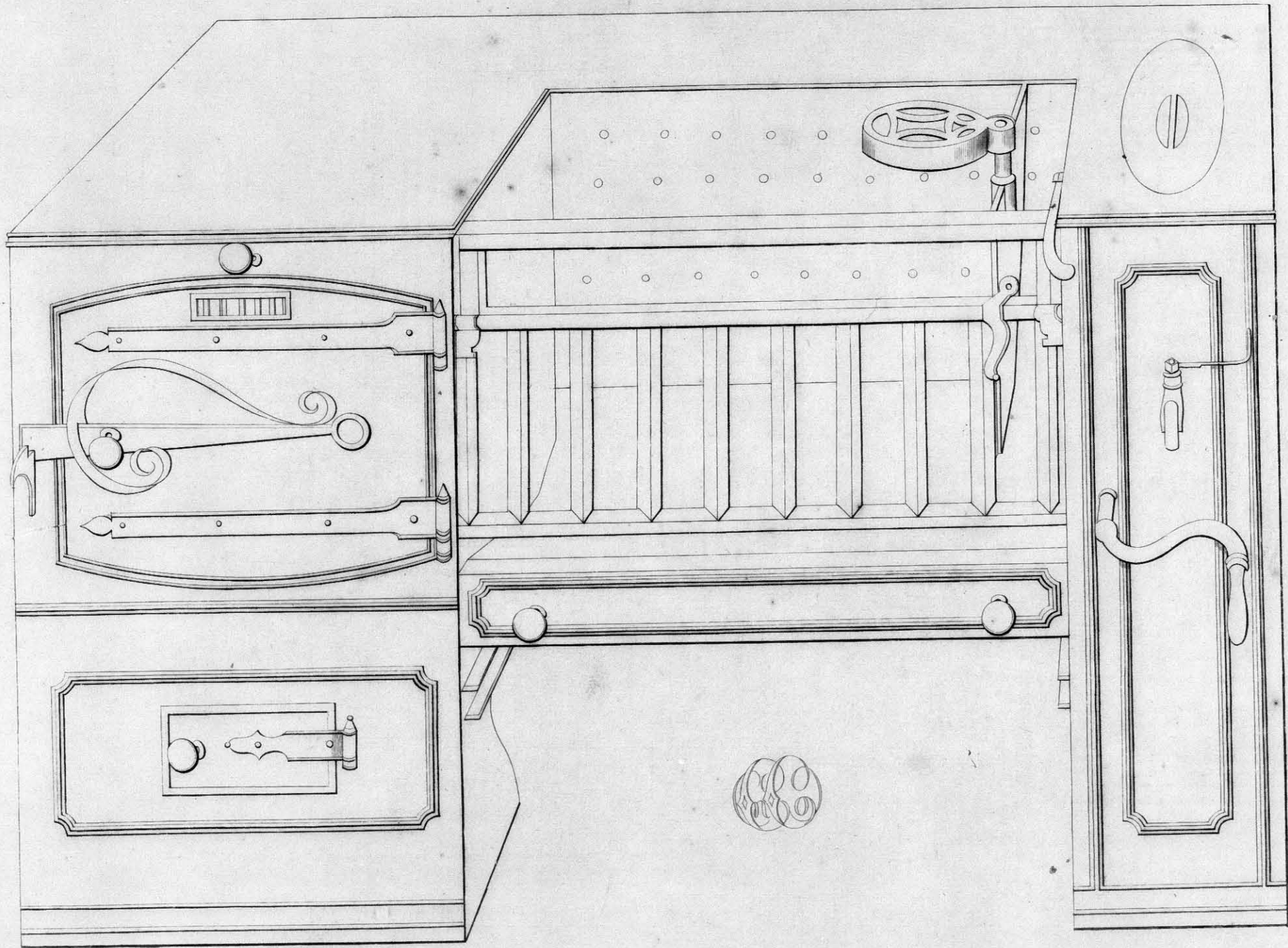

G. L. B. B. RANGE

Sizes 38 40 42 45 x 24 48 52 x 26 54 60 x 30 Inches

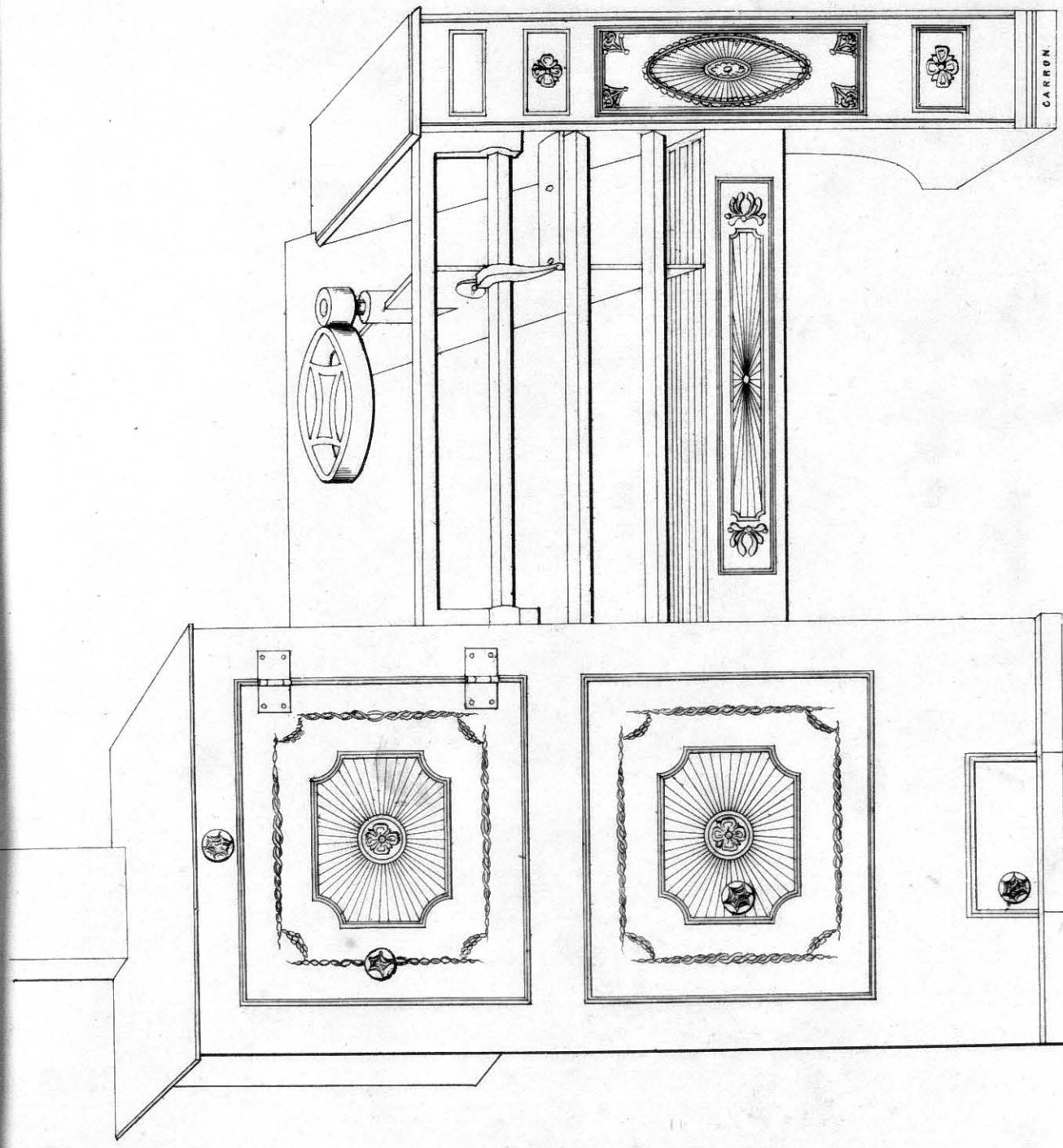

Liverpool Range, either with wrought or cast Iron Bars.

Sizes 30 to 48 Inches.

This Range can either be made complete as above or as a steam range.

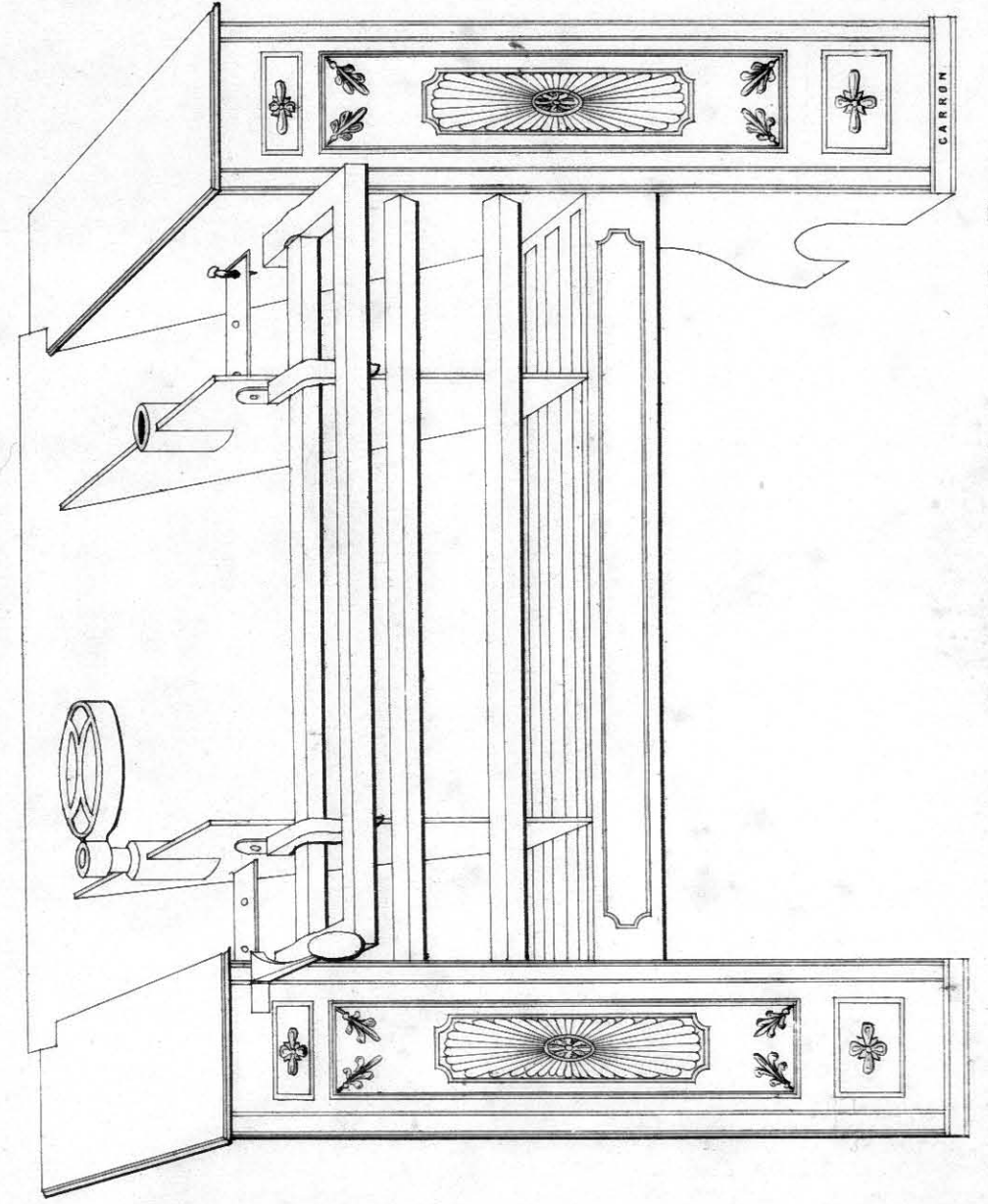

Stiglitz Küchen Grate, either with wrought or cast Iron Bars.

Sizes 30 to 48 Inches.

Maclure & Macdonald, Lith.
17 Buchanan St.

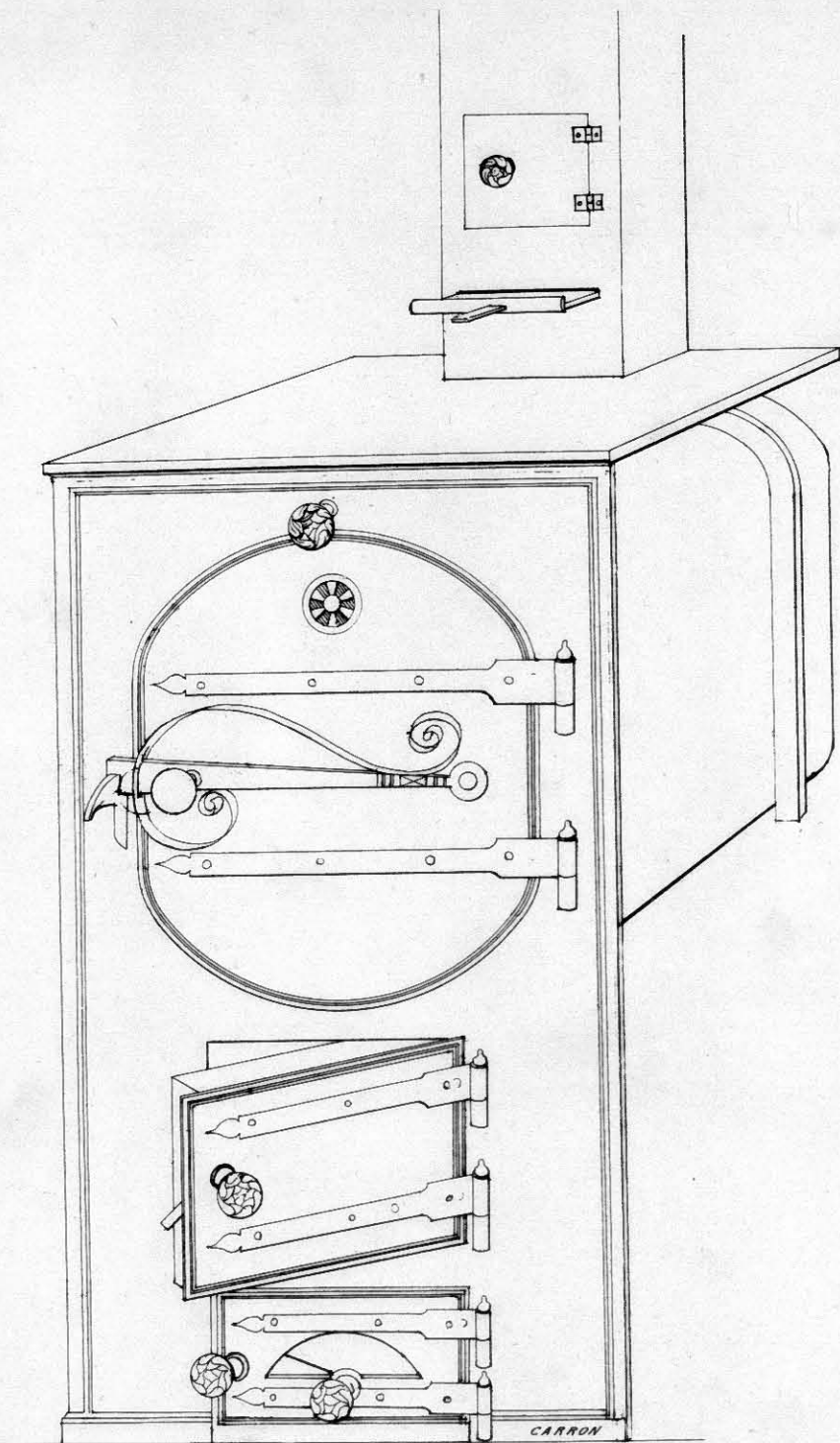

Elliptic Oven with front Plate, Hob & Saddle.

Sizes of Oven, 14 to 24 inches.

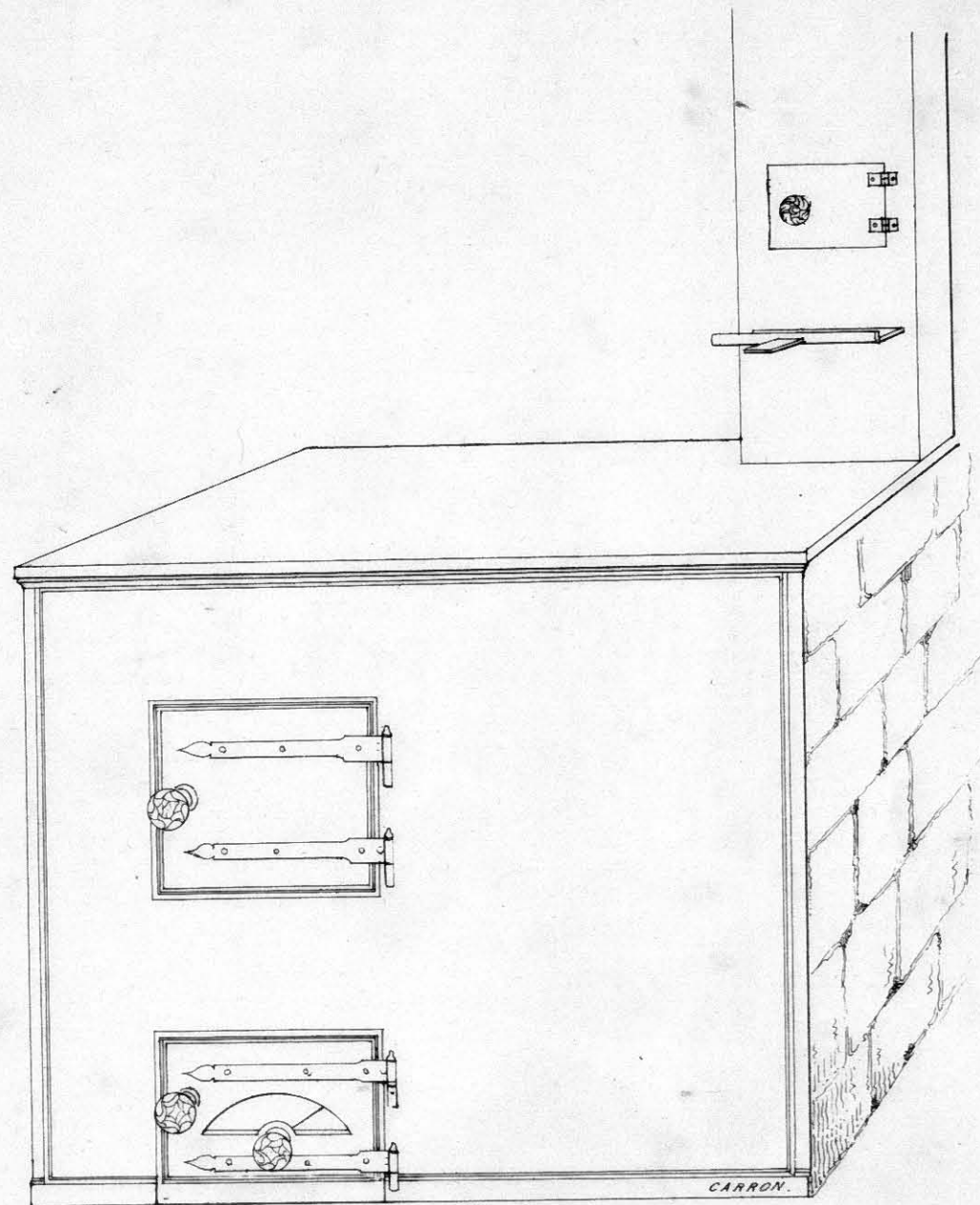

Hot Plate with front Plate.

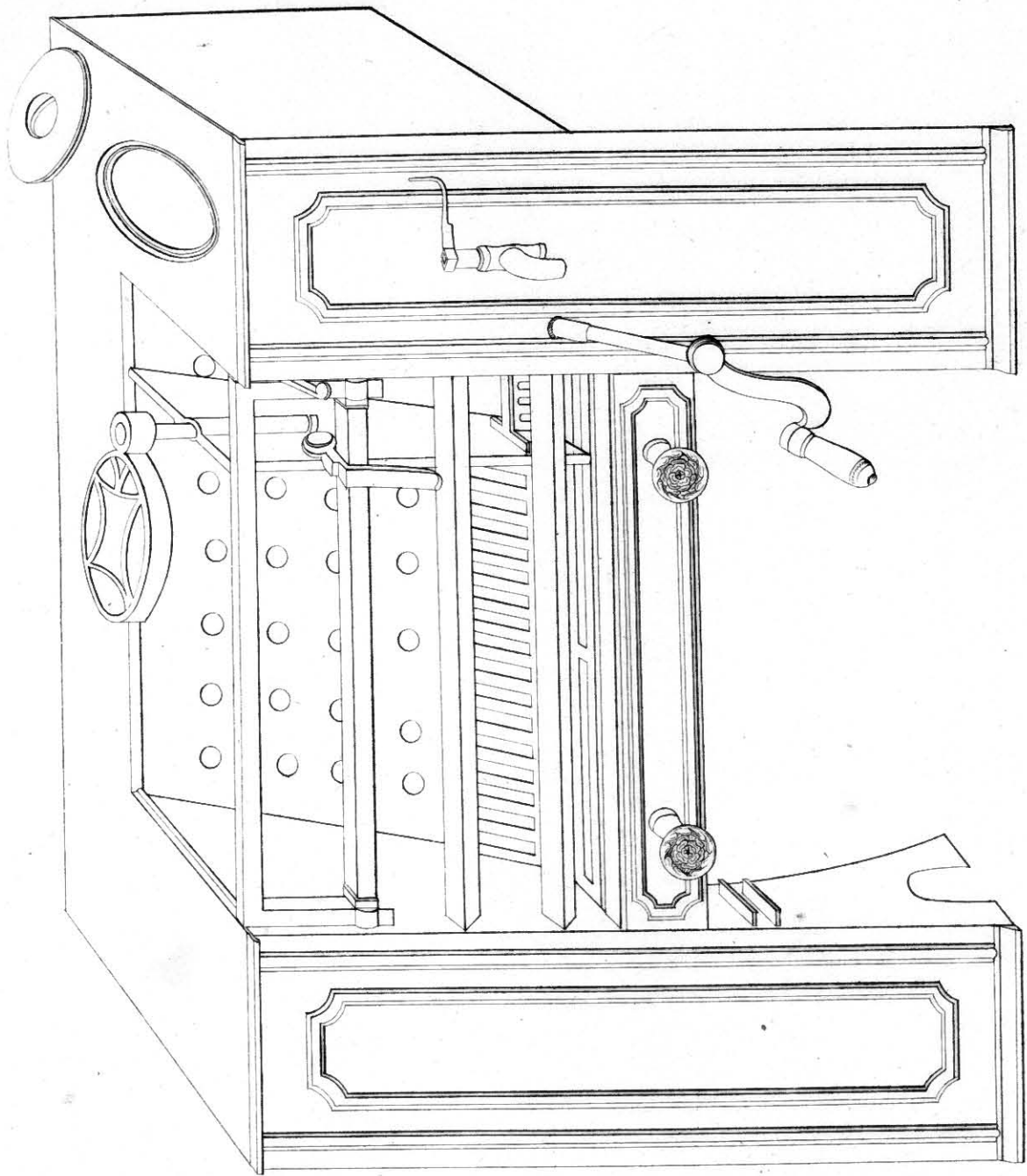

Back Boiler Range with plain Front,

Sizes 25 to 43 inches.

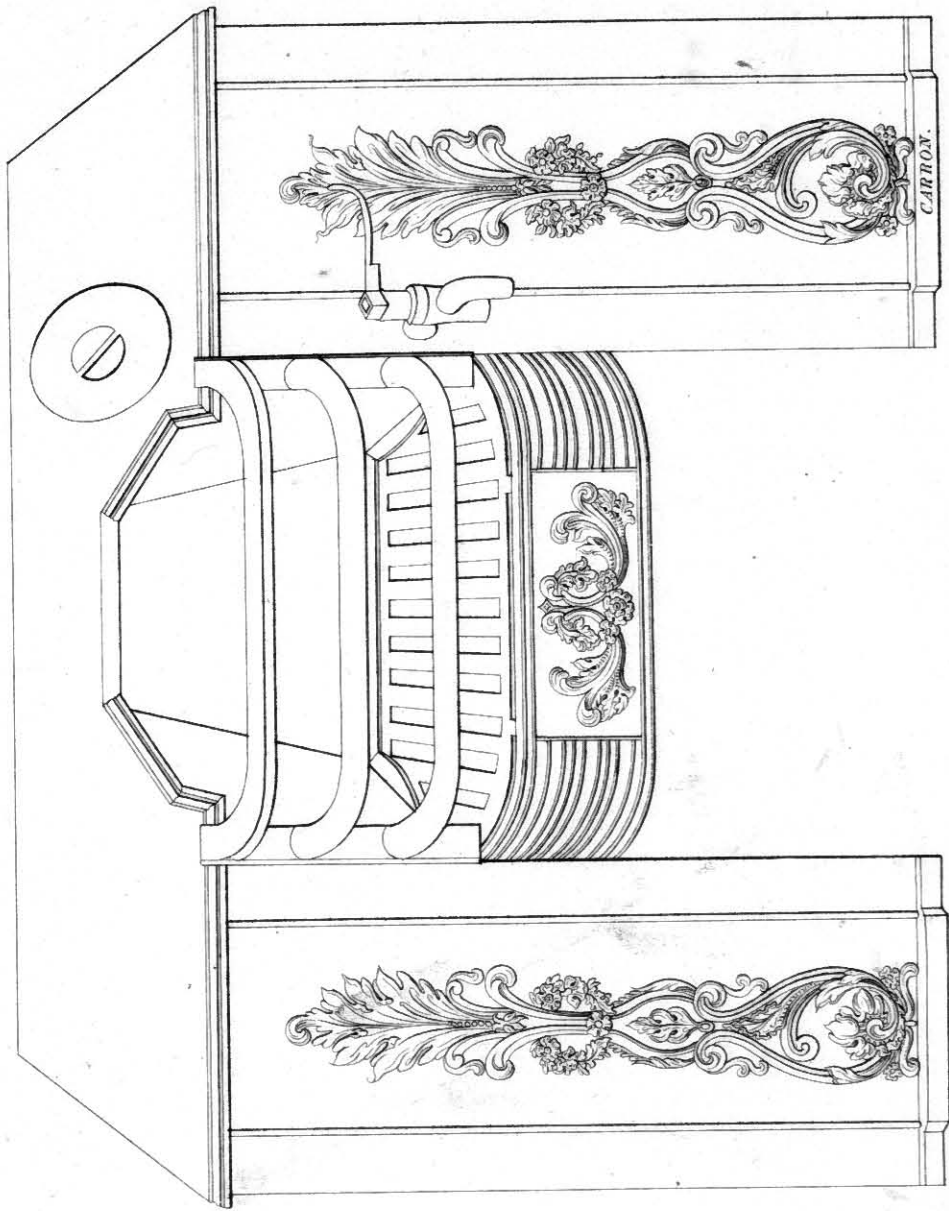

Elliptic Stove with Back Boiler,

Sizes 24 to 38 inches with 12 or 14 inches fires,

& one or two holes in the boiler top.

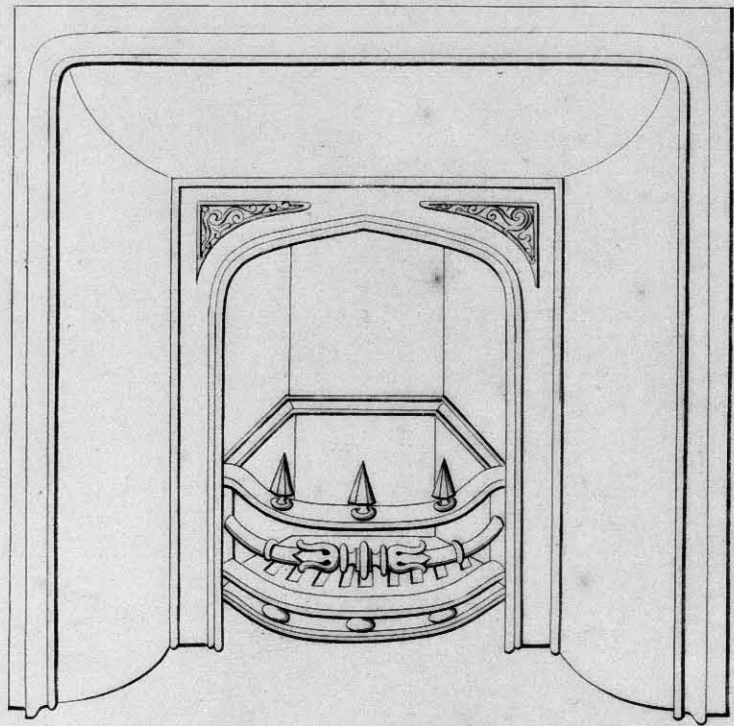

*Kinnaird Stove, N^o 167 with Iron or Brick back.
Sizes, from 32 x 36 to 42 x 42 inches.*

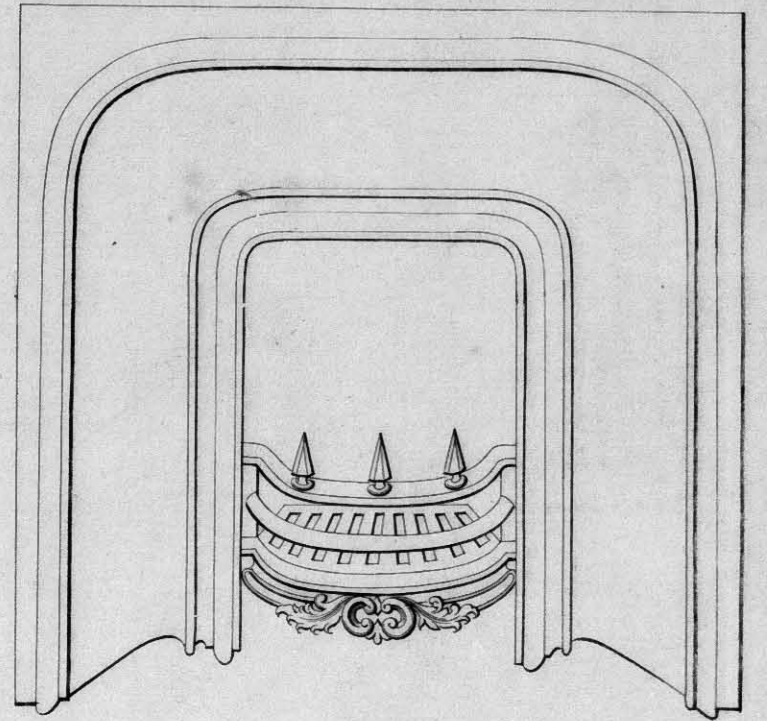

*Sham Kinnaird Stove N^o 180 with N^o 7 bars.
Sizes, 30-32-34 x 36-36-38 x 38 & 40 x 40 ins.*

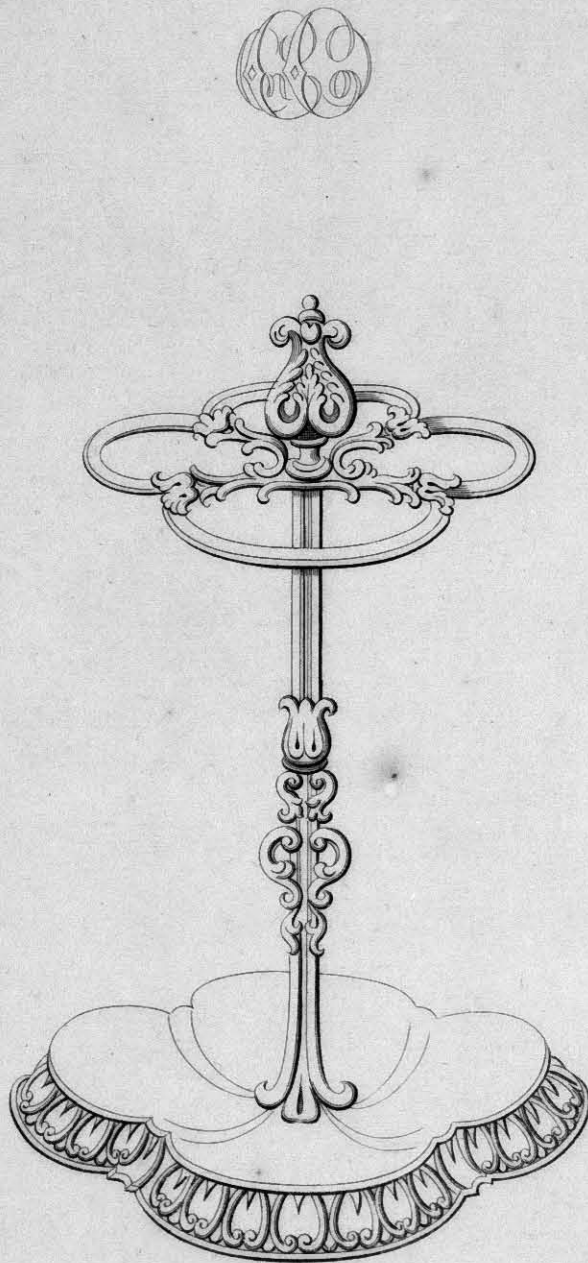

Umbrella Stand N^o 8.

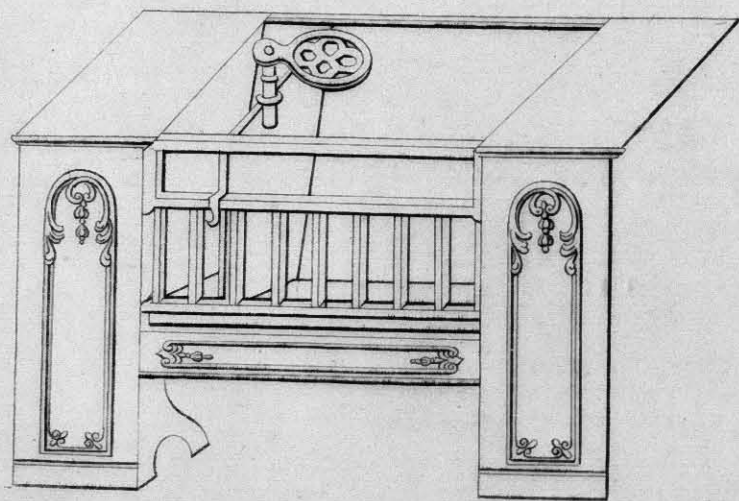

Slight Kitchen Grate N^o 166. Sizes 24 ins & upwards

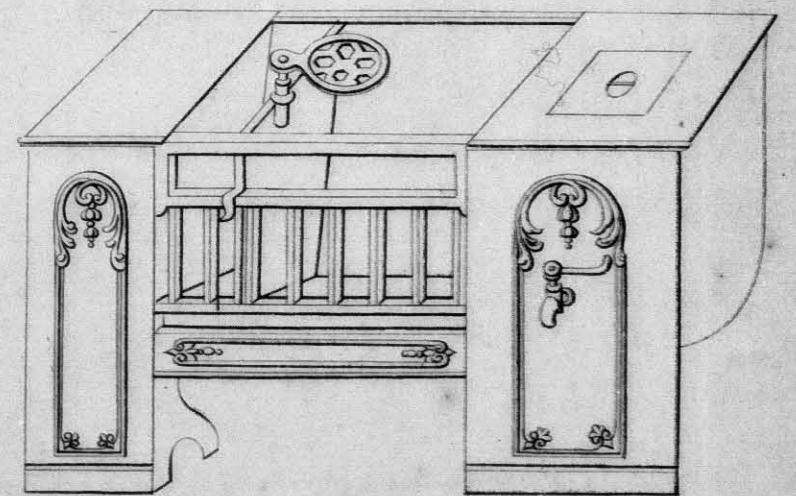

*Slight Kitchen Grate N^o 166 with Boiler.
Sizes, 30 ins. and upwards.*

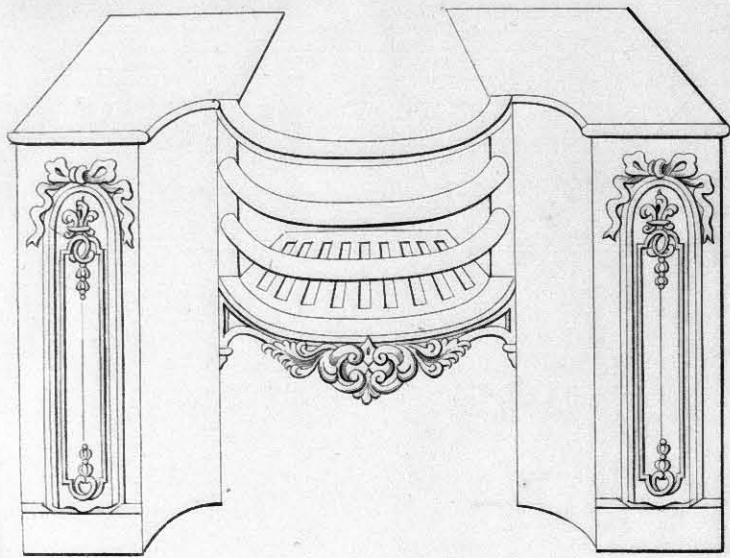
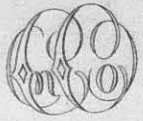

*Leith Concave Sham Stove 20ins high
Sizes 28 up to 38 inches*

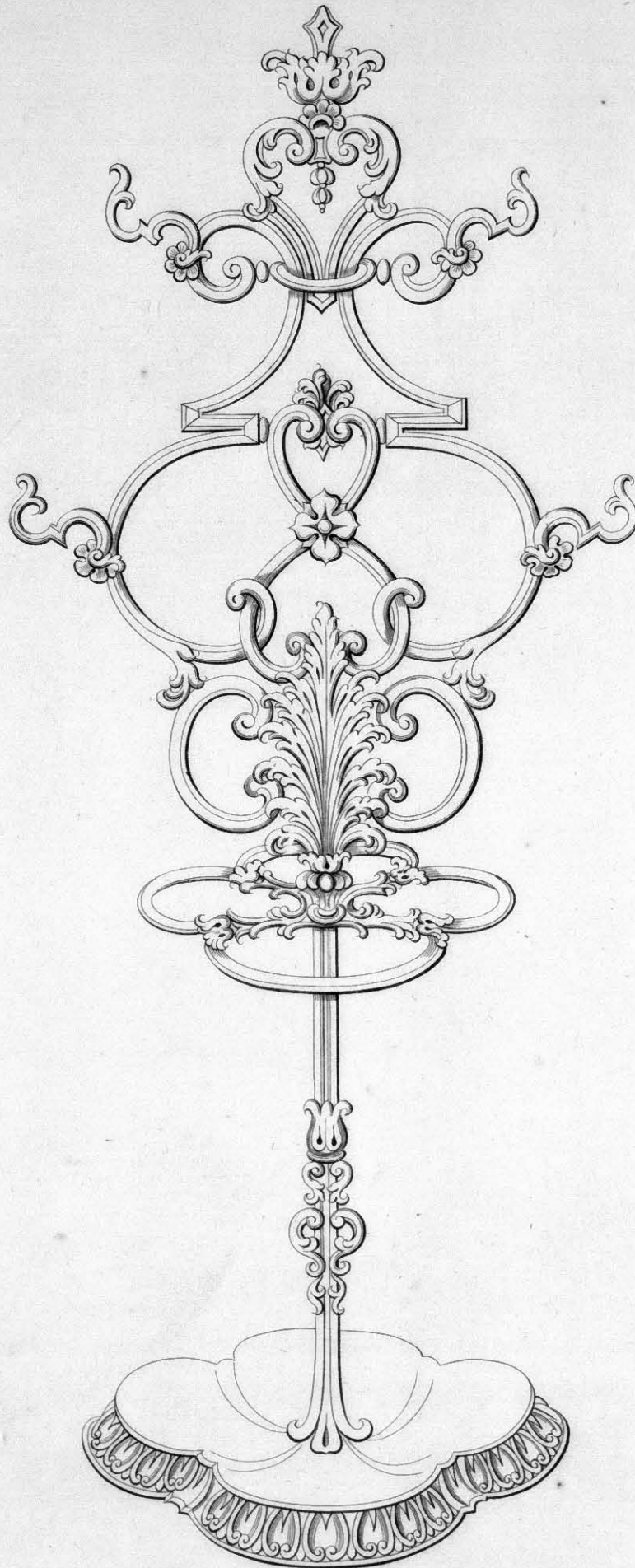

N°8 Umbrella and Hat Stand 54ins. high.

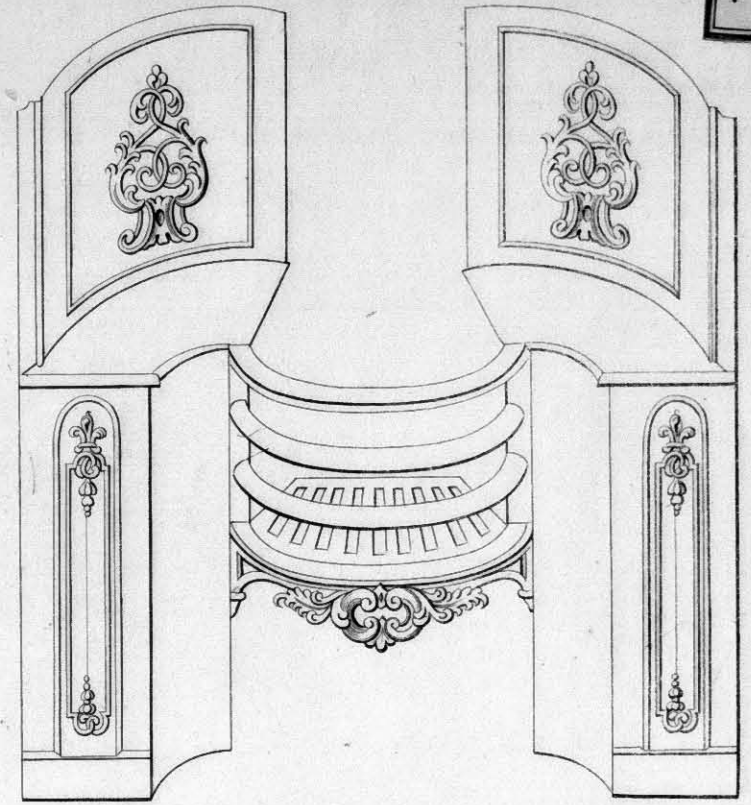

*Leith Concave Sham Stove 18 ins. high with Covers
Sizes 24 up to 31 inches*

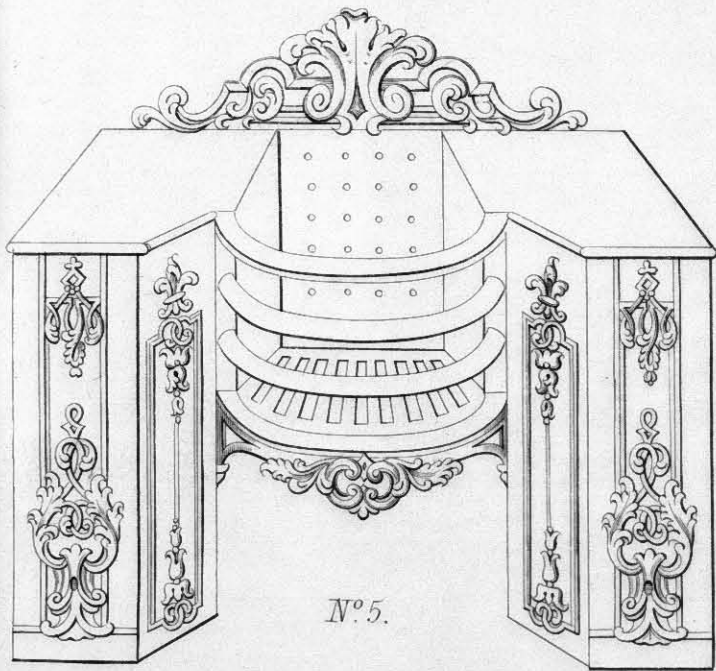

N°5.

S.E. Stove with N°171 Front. Sizes 18 to 40 ins.

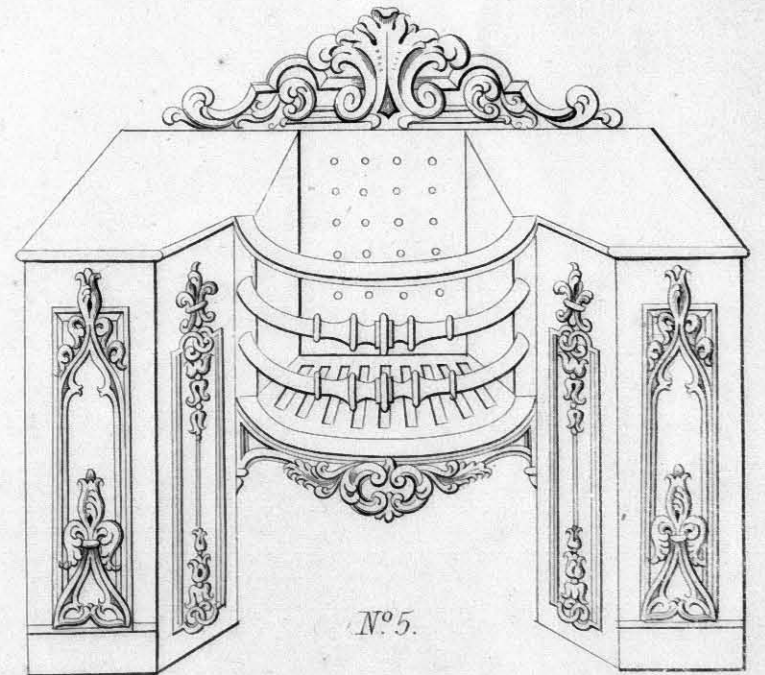

N°5.

S.E. Stove with N°163 Front. Sizes 18 to 40 ins.

PLATE 13



UMBRELLA STAND
No 6



UMBRELLA STAND
No 7

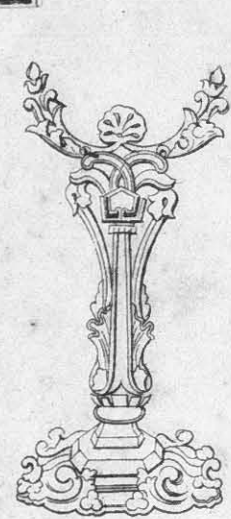

No 2



No 4



No 5



No 7

FENDER STANDARDS

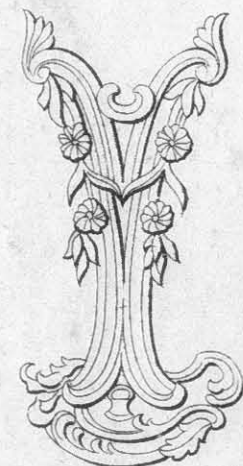

No 8



No 9

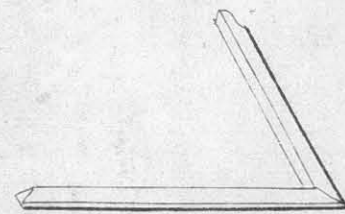

L

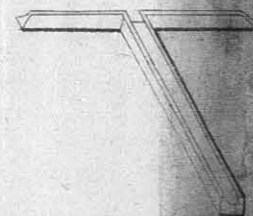

FENDER STOPS

T



REGISTER TRADE

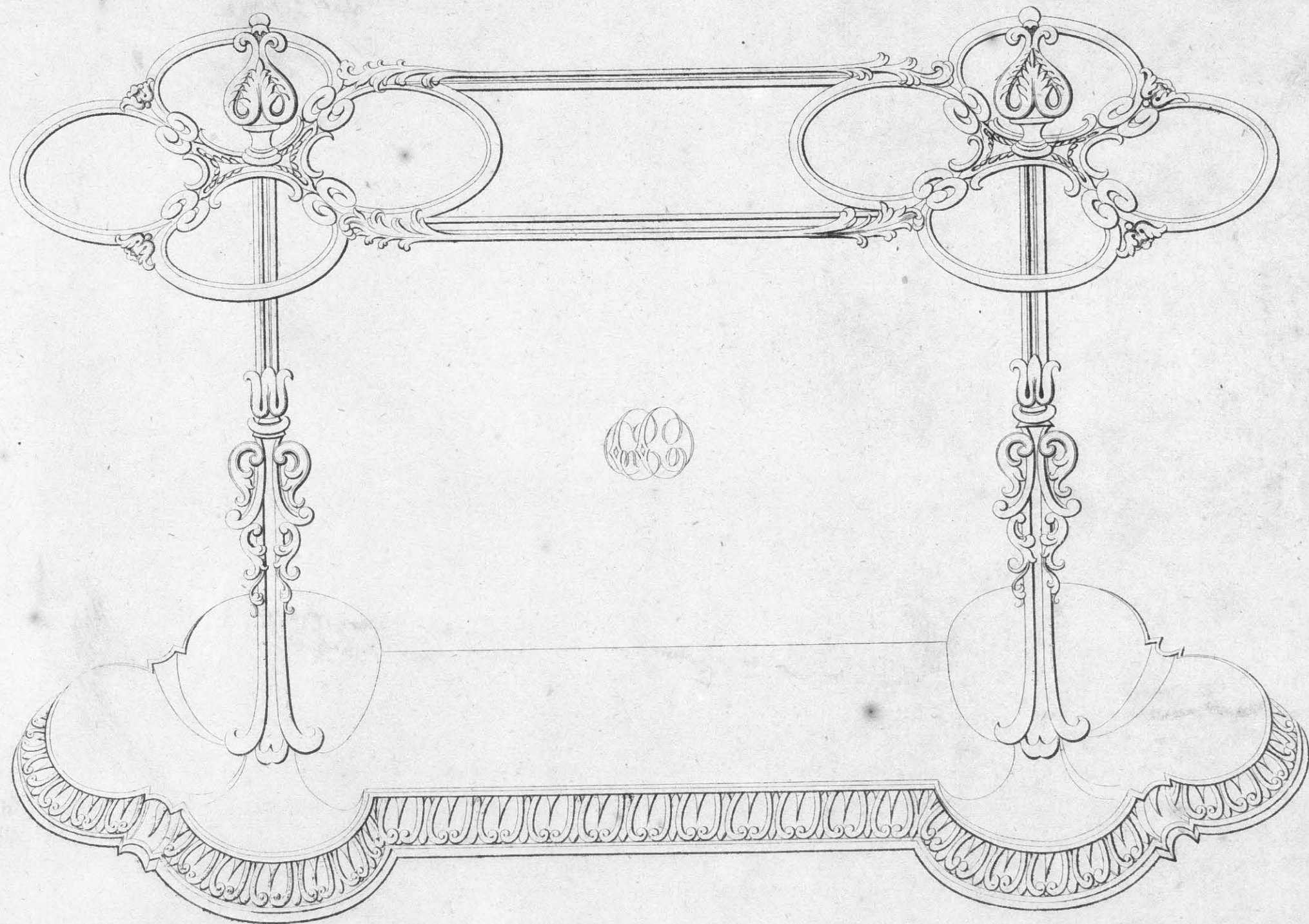

Umbrella Stand No. 9
No. 8 is this pattern with only a single stem.

Eng^d by Kirkwood & Son, Edin^r.

Umbrella Stands.

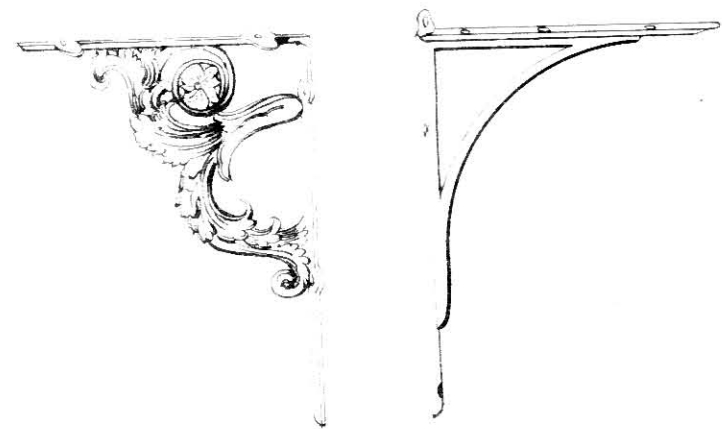
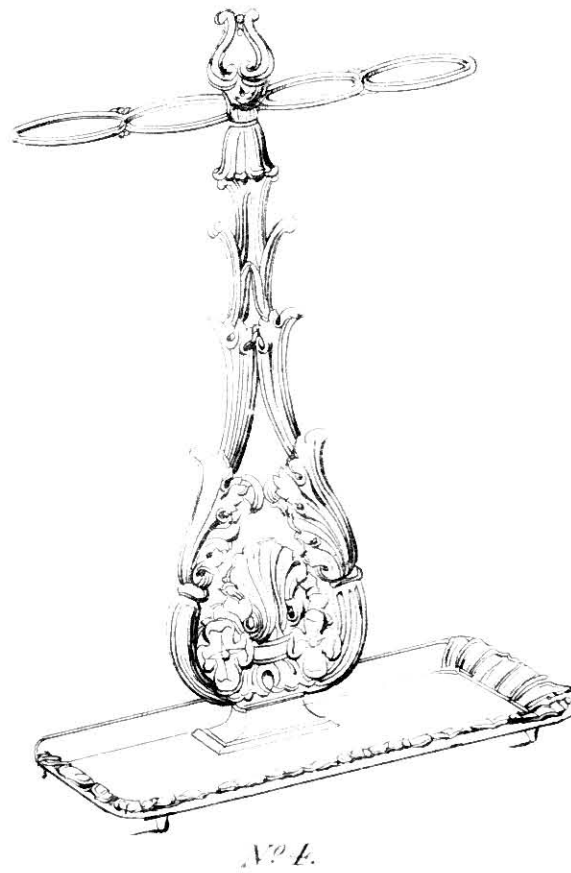
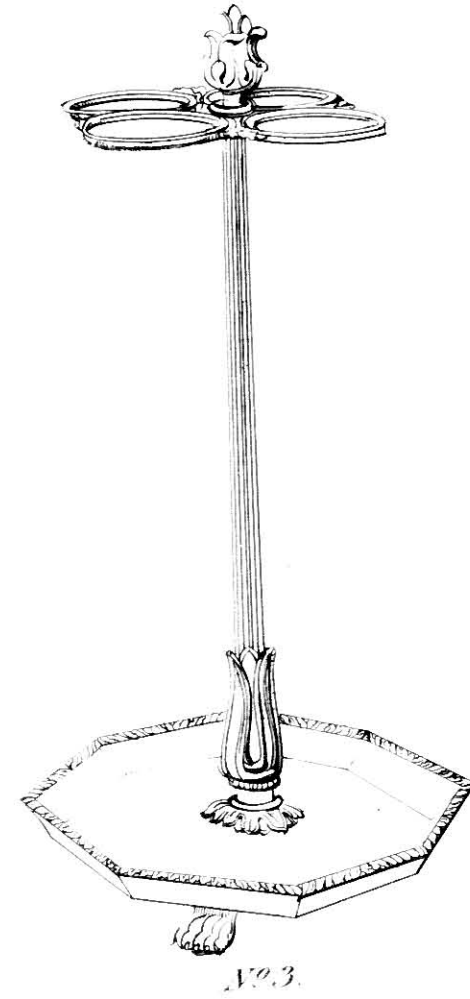
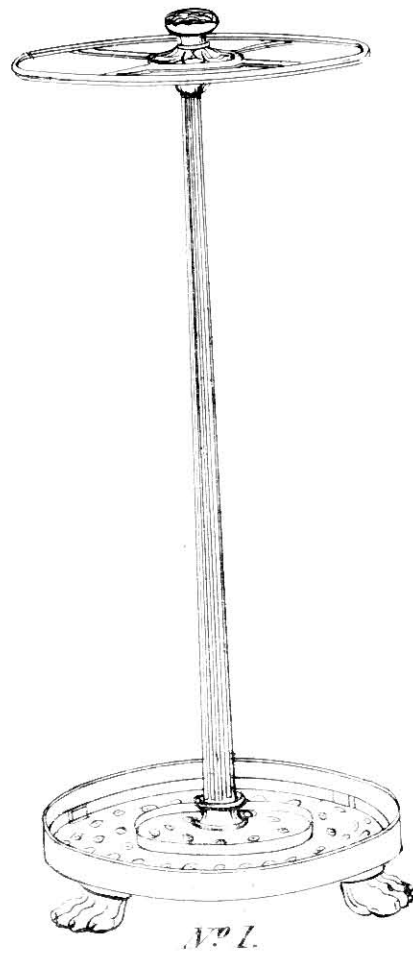
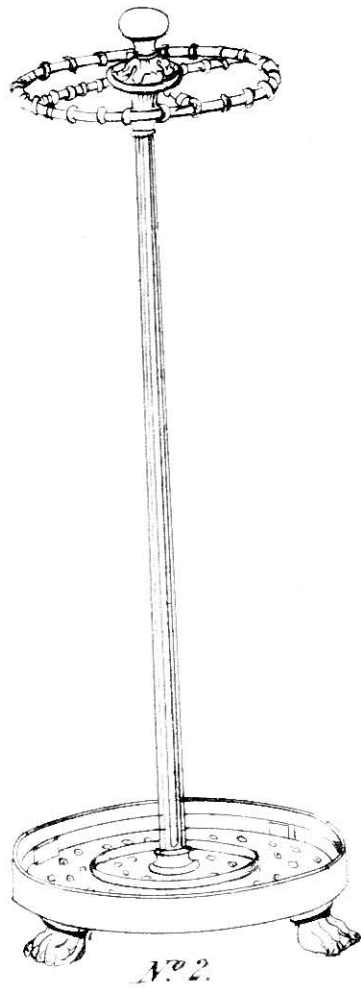

Shelf Brackets
ornamented
 5" 1. 2. 3.
 8 1/2" 10" 11" 11 1/2" 12 1/2" inches
Plain 11" 13" inches.

N. 2 Garden Chair

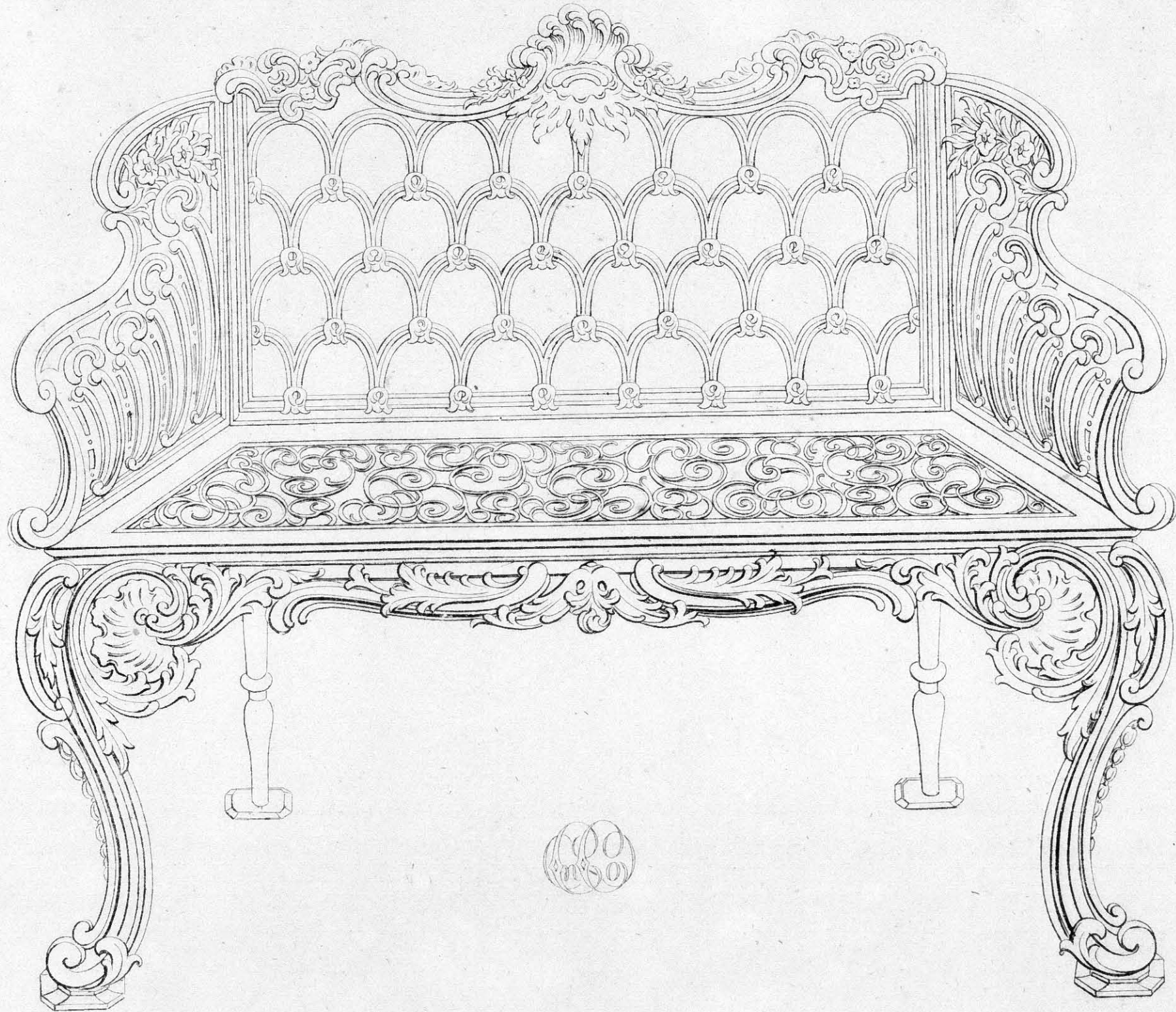

Sizes each 3 ft. 10 ins. and 5 ft. 2 ins. extreme length.

Eng^d by Kirkwood & Son, Edin^r

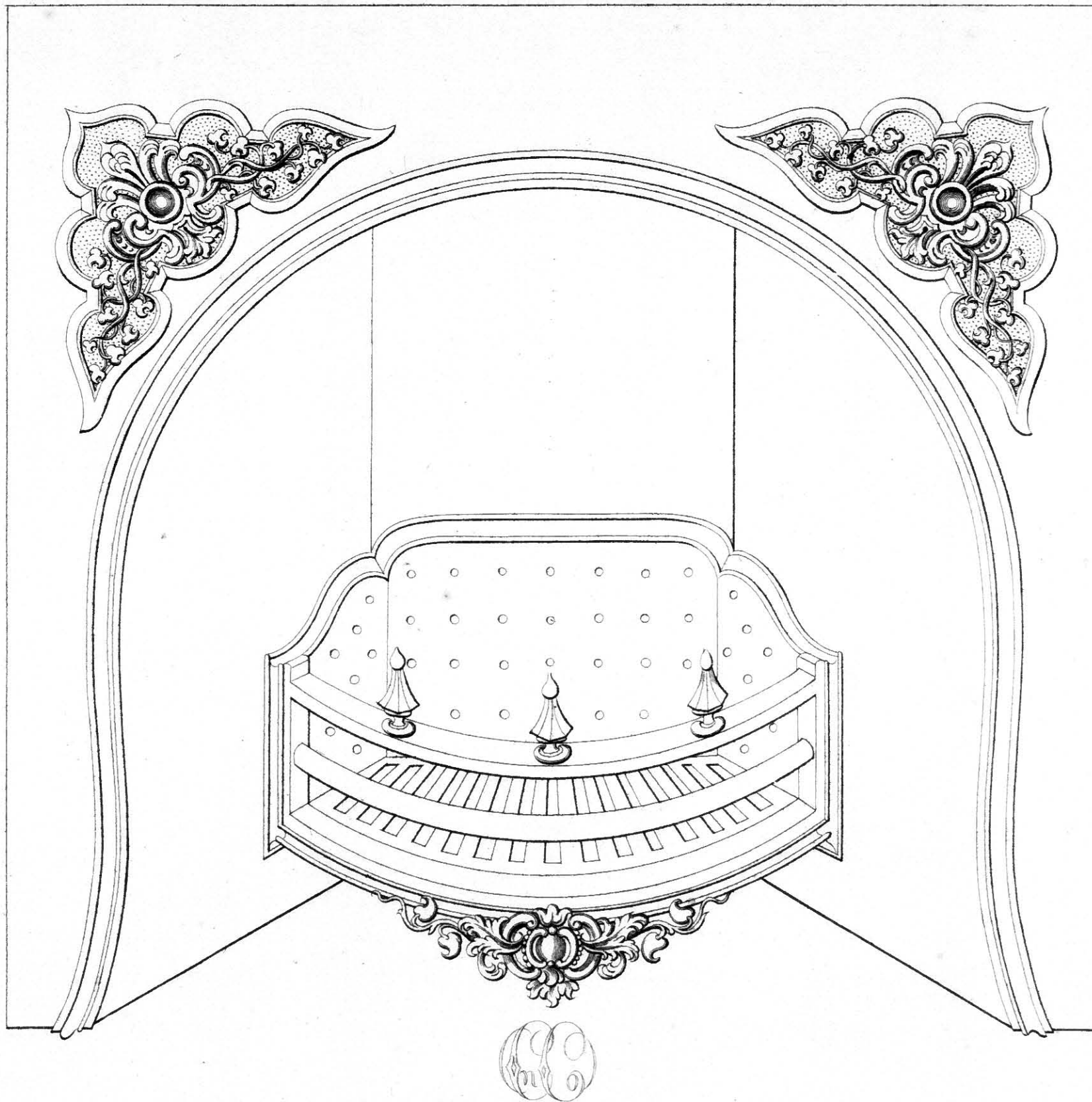

REGISTER STOVE N° 181.

*Ground Front & Cheeks. Screwed on Mouldings.
N° 8 Fire. N° 32 Fret. Sizes 36 x 38 to 42 x 42 inches.*

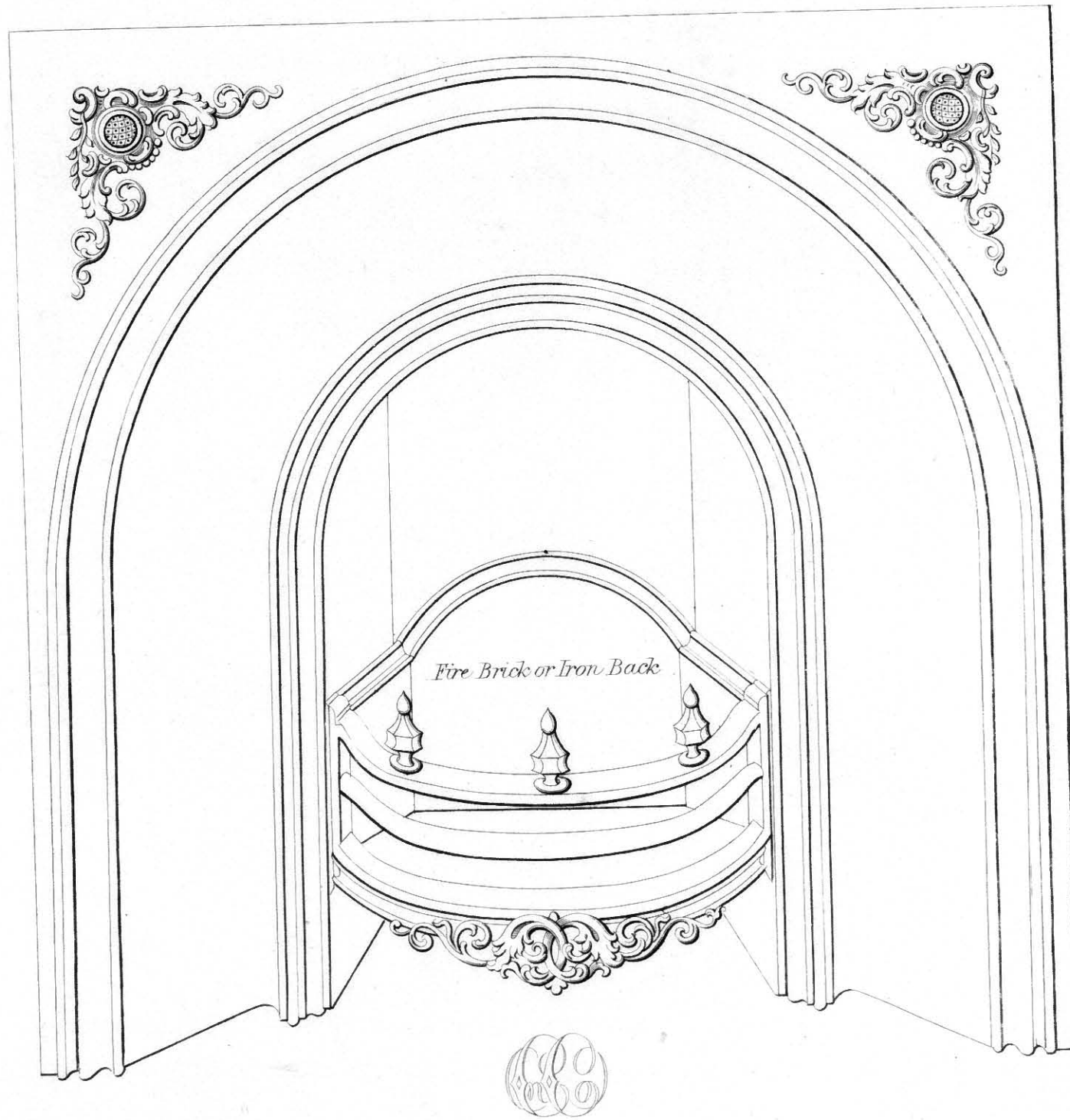

BRUCE STOVE N° 179
Sizes 34 x 36 to 42 x 42 inches.

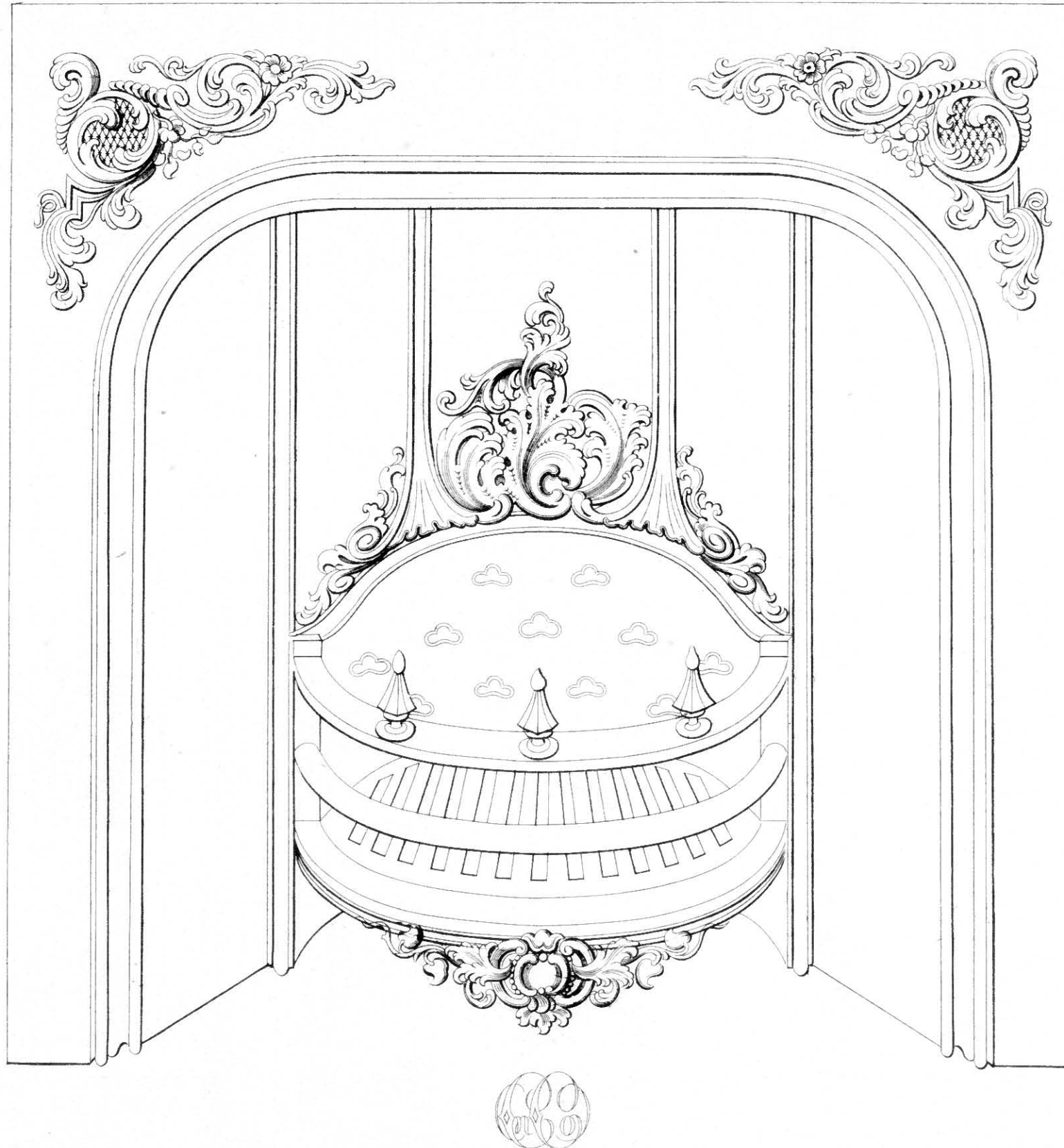

REGISTER STOVE N° 182.

N° 5 Back_ N° 7 Bars_ N° 32 Fret.

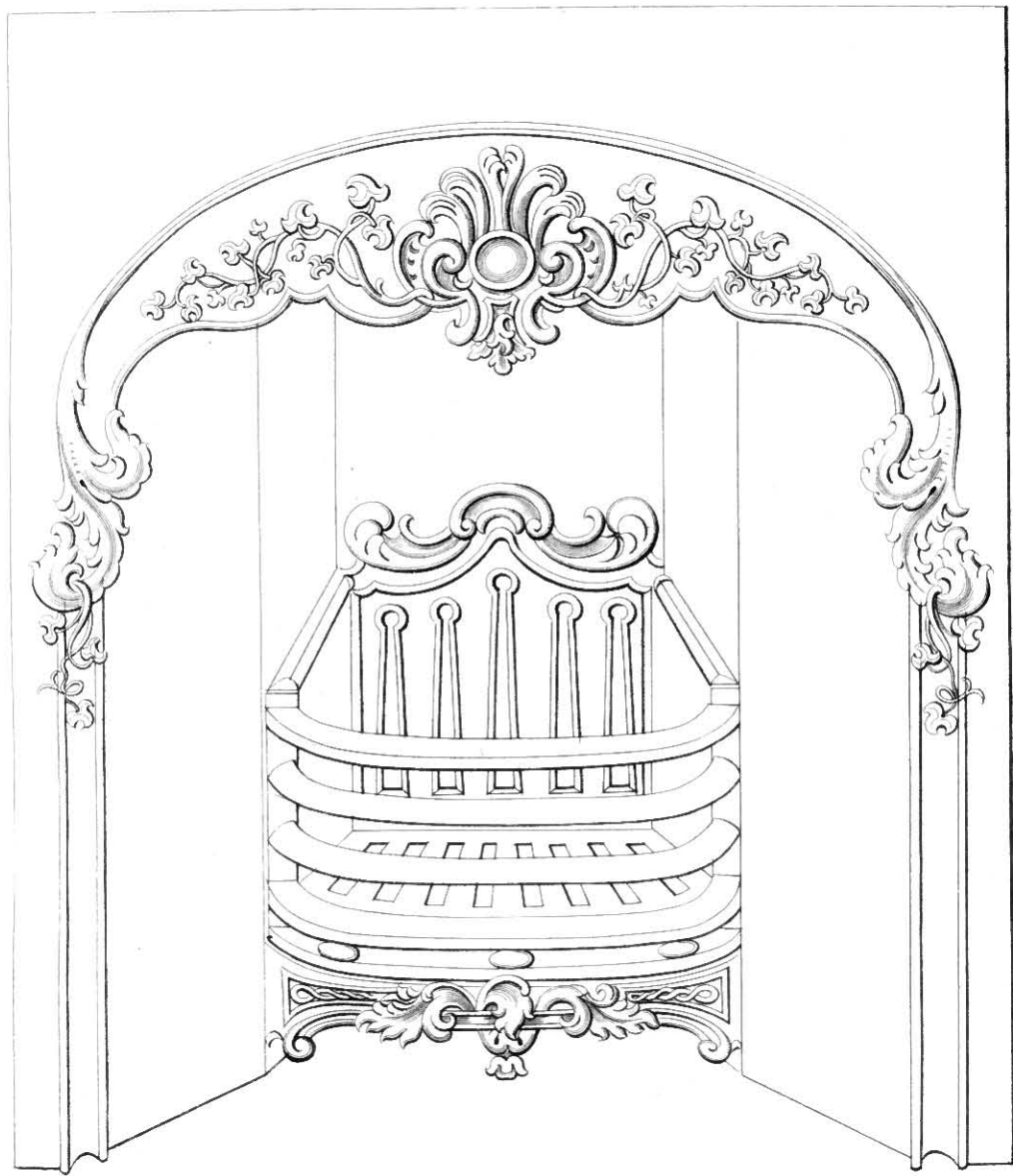

REGISTER STOVE.

*No 176 Front - No 6 Back - No 24 Fret.
Sizes - 32 - 34 x 36. 36 & 38 x 38 inches.*

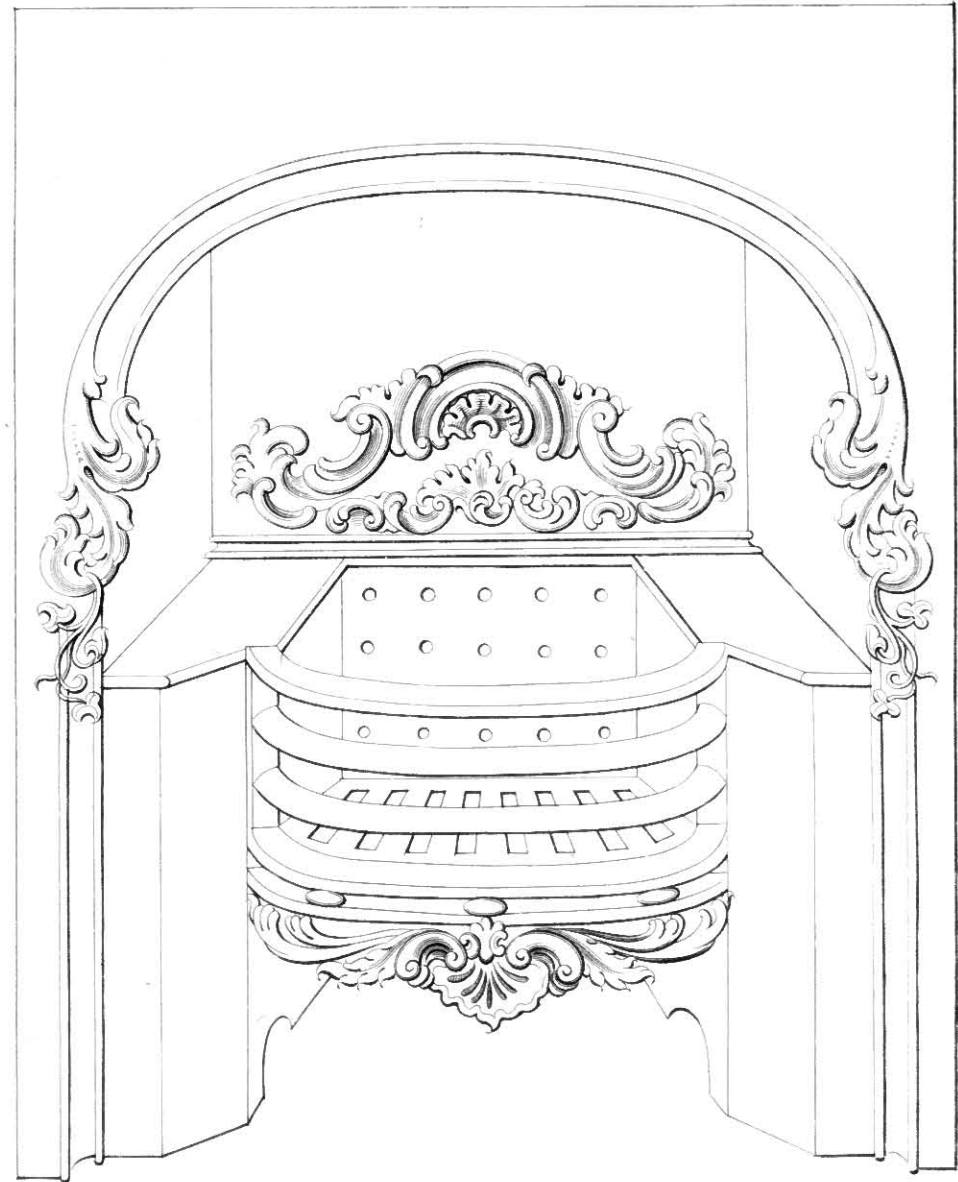
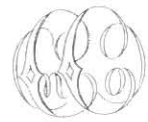

RECESS REGISTER STOVE.

*No 178 Front - No 8 Back - No 20 Fret.
Sizes - 24 - 26 - 28 - 30 - 32 - 34 x 36. 36 & 38 x 38 inches.*

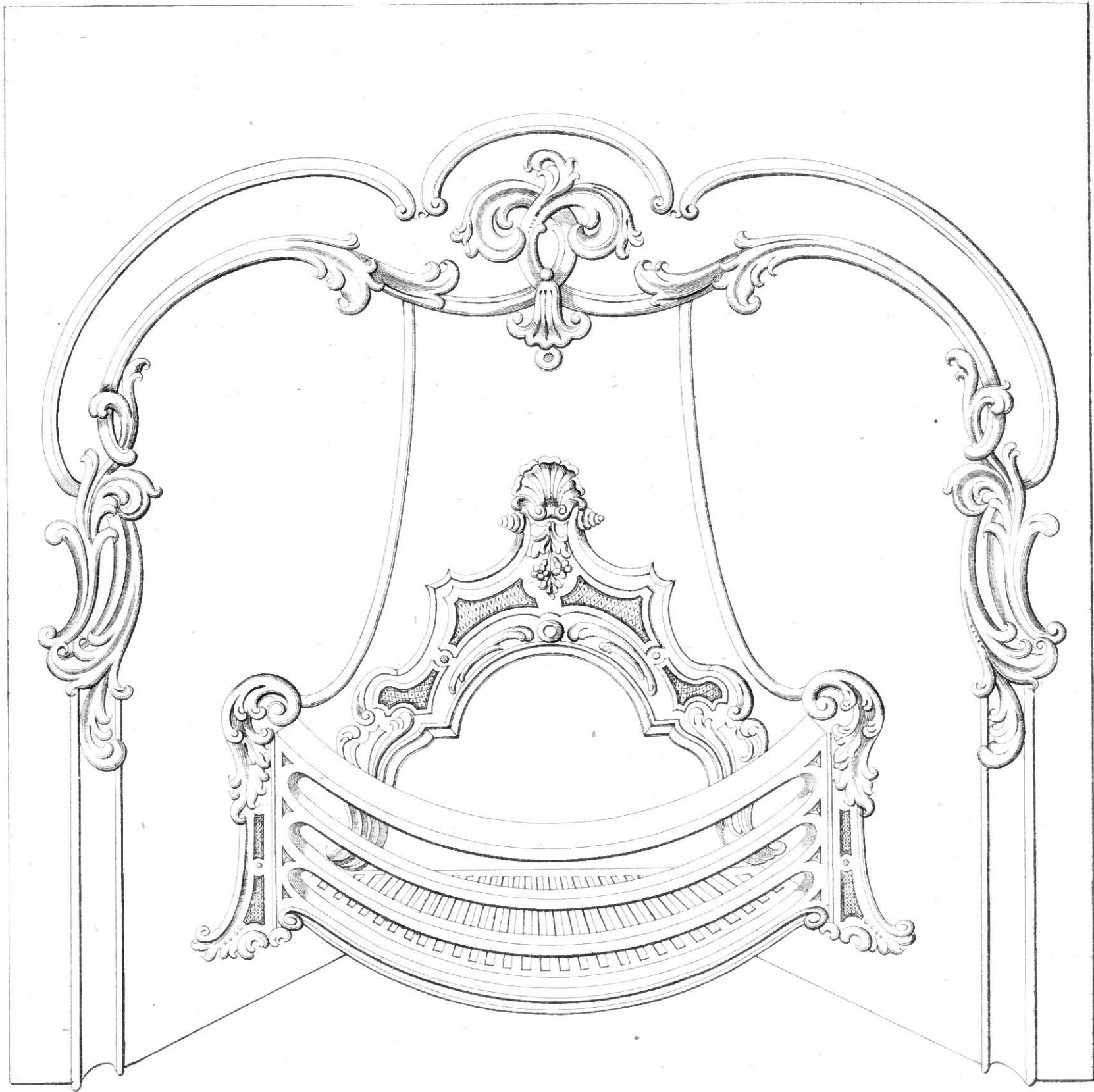

REGISTER STOVE N^o 184

Sizes 30 32 34 x 36 ins. 36 & 38 x 38 ins.

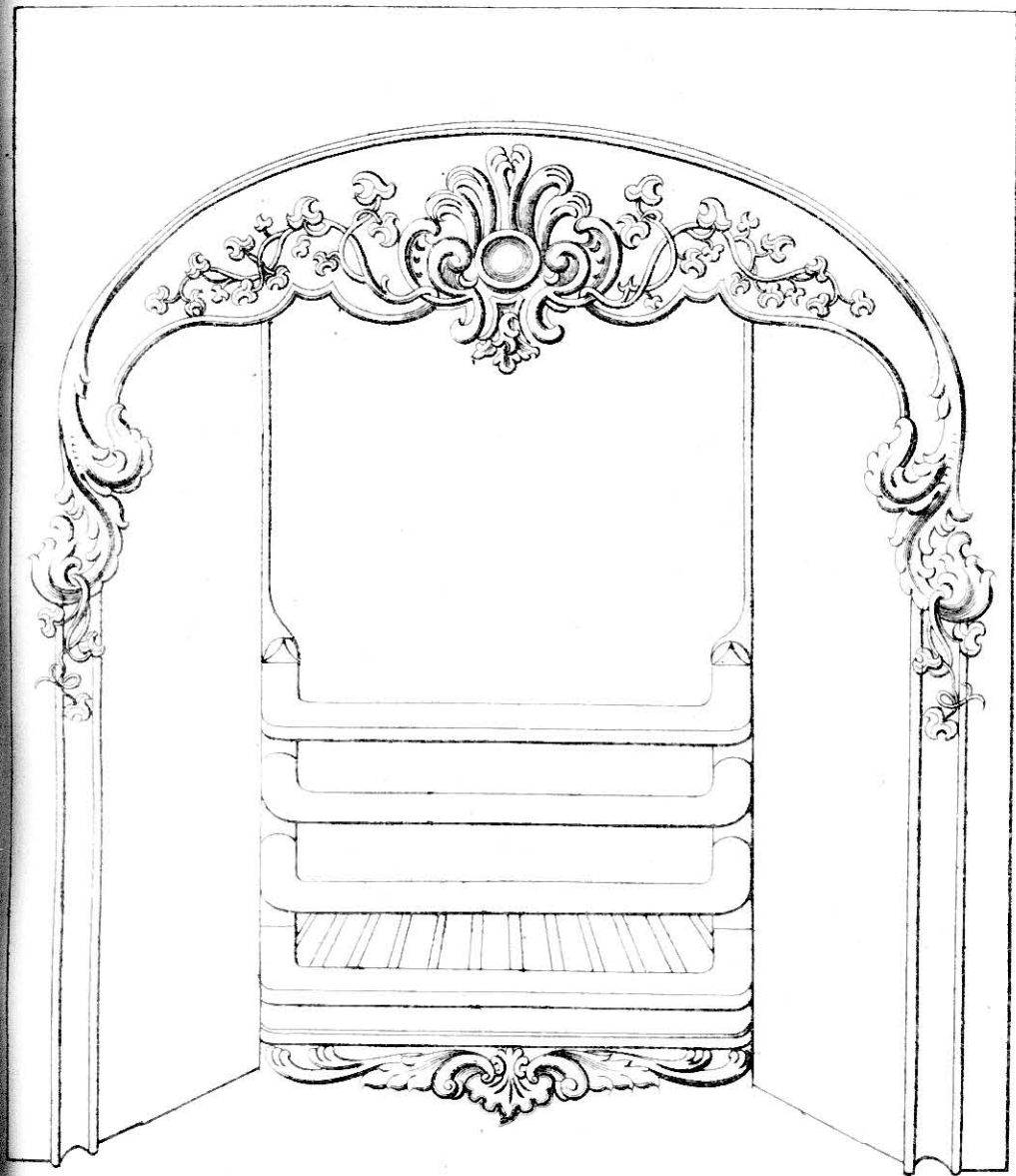

SHAM REGISTER STOVE
N^o 176 Front. L. Bars. - N^o 24 Fret.
Sizes 32-34 x 36. 36 & 38 x 38 inches

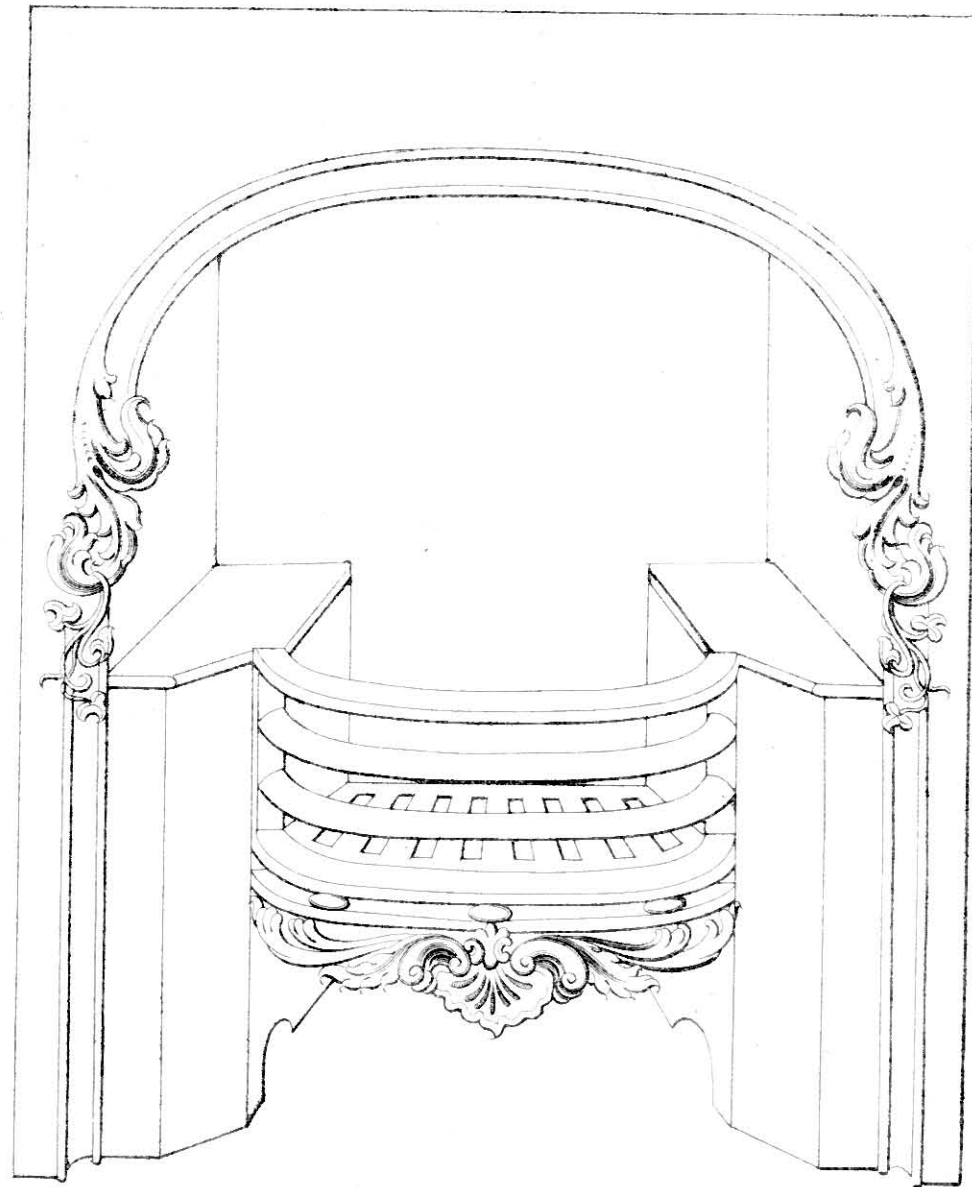
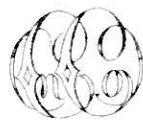

SHAM RECESS REGISTER STOVE
N^o 178 Front. N^o 20 Fret.
Sizes 24-26-28-30-32-34 x 36. 36 & 38 x 38 inches

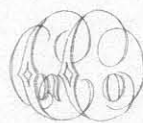
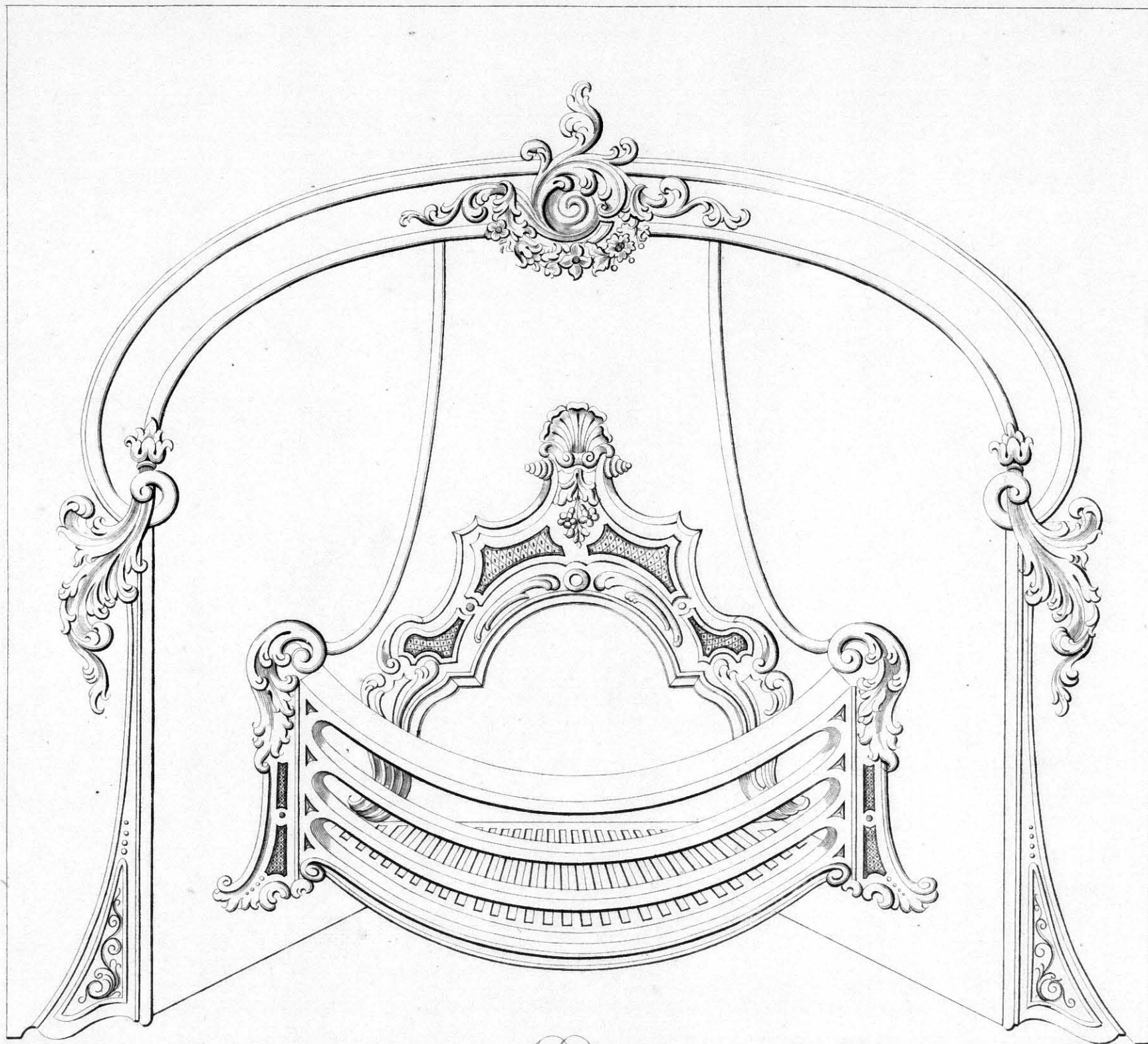

REGISTER STOVE. N^o185 with N^o184 back.

Sizes 30 32 34 x 36 ins. 36 & 38 x 38 ins.

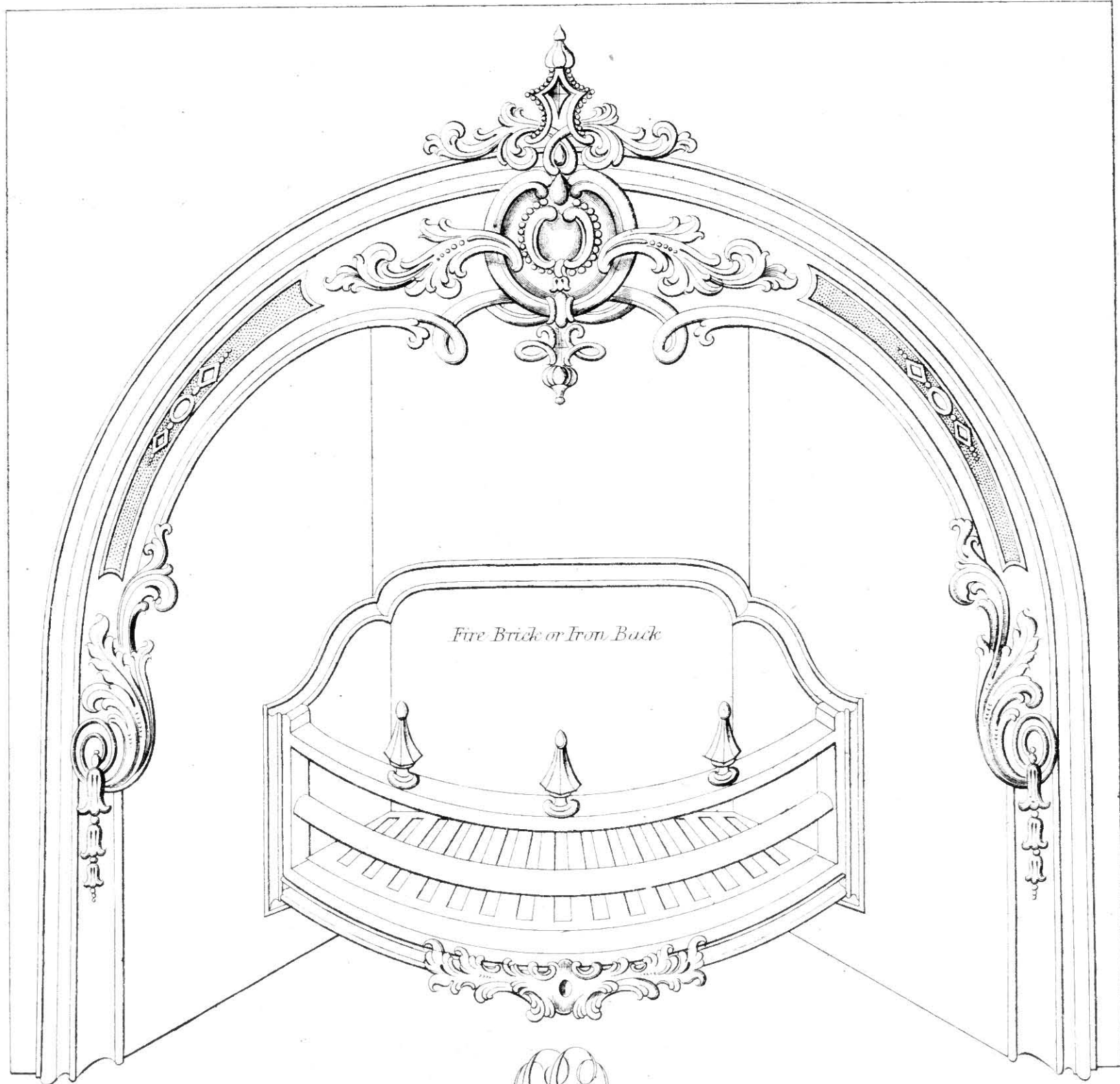

Kirkwood & Son, Edin^r

REGISTER STOVE N^o 177

Sizes 34x36 ins. 36 & 38x38 ins. and up to 43 inches

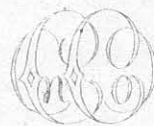
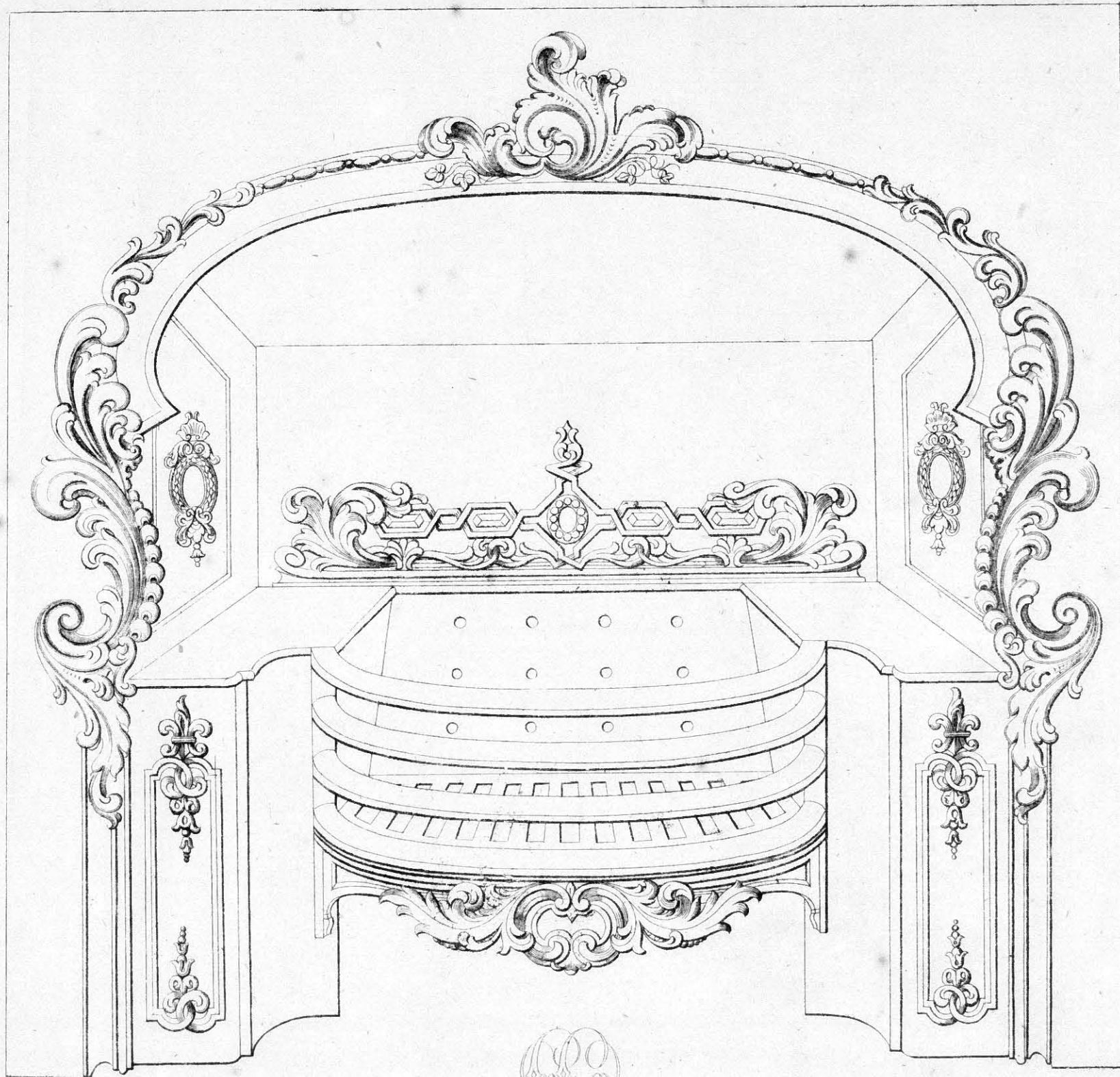

Register Stove
N^o 172 Front with N^o 169 Metal
Sizes 30-32-34x36 36-38x38 Ins.

Eng^d by Hickwood & Son Edit^d

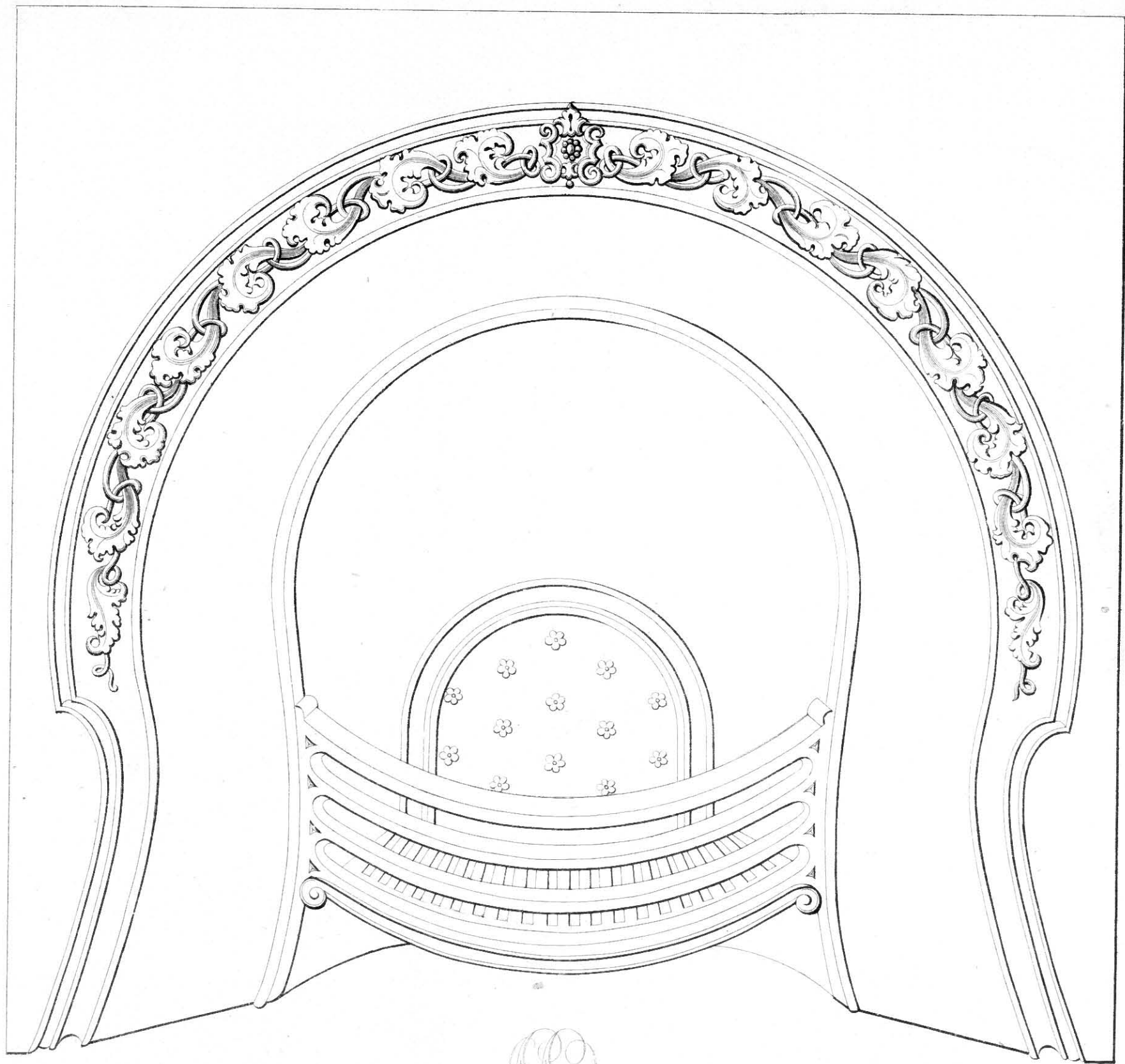

REGISTER STOVE N^o 186 with Fire Brick or Iron Back

Sizes 24. 26. 28. 30. 32 & 34 x 36. 36 x 38 Inches.

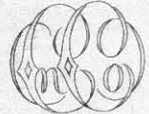
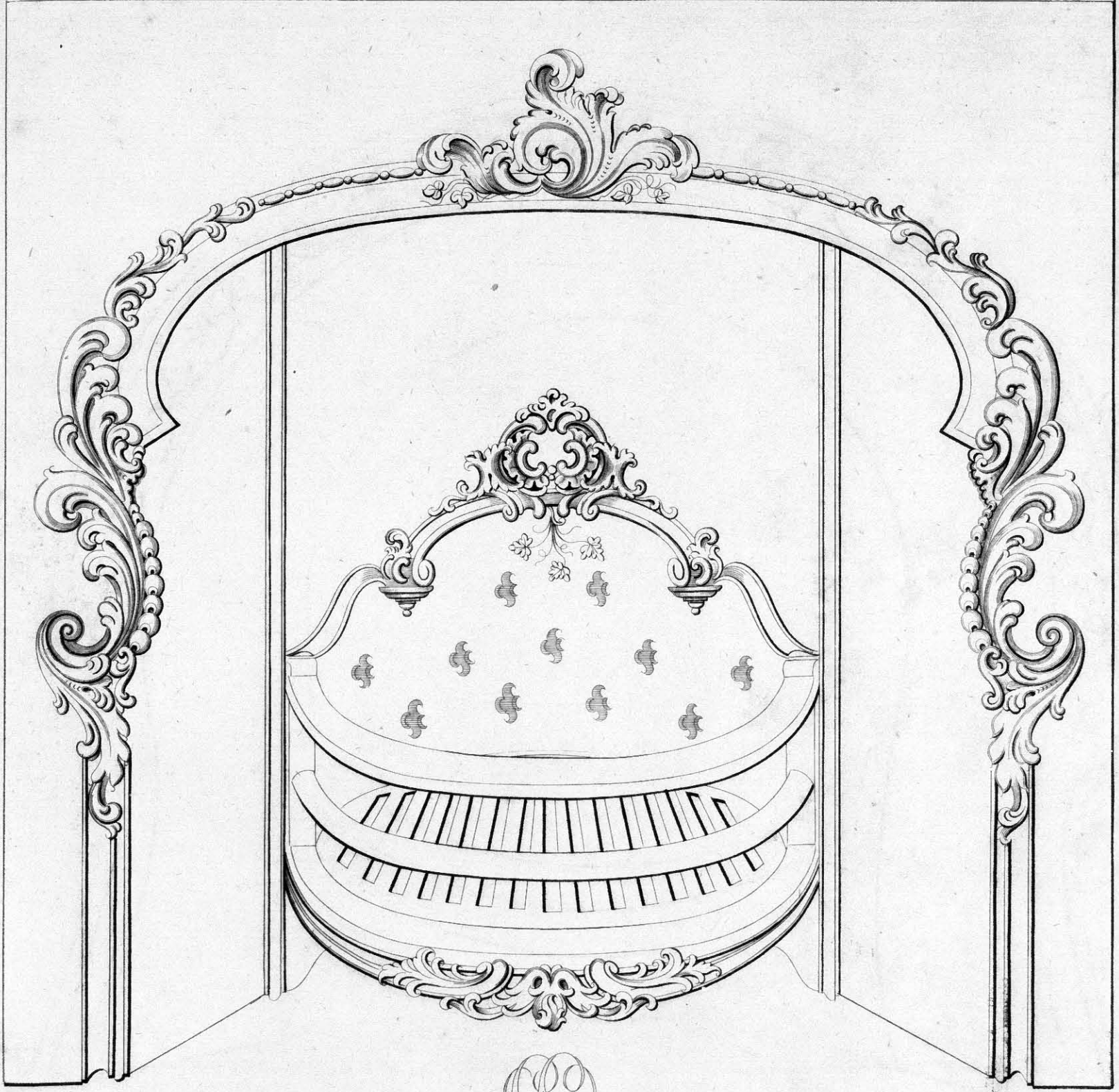

Register Stove

*N^o 175 Front N^o 4 round back plain cheeks N^o 7 bars
Sizes 30 32 34 x 36 ins 36 & 38 x 38 ins*

Eng^d by Kirkwood & Son Edin^r

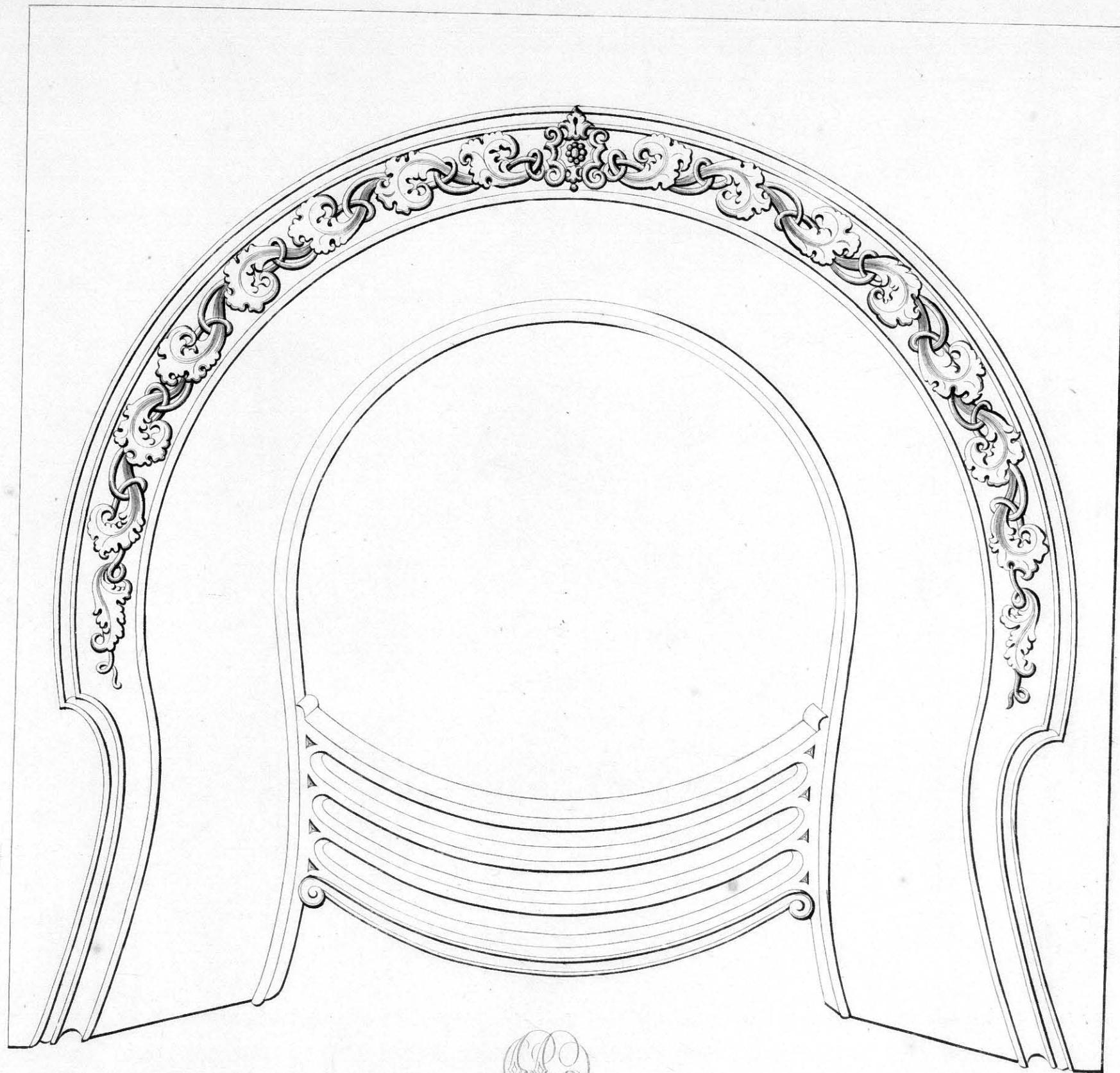

SHAM REGISTER STOVE N^o 186

Sizes 24. 26. 28. 30. 32 & 34 x 36. 36 & 38 x 38 Inches.

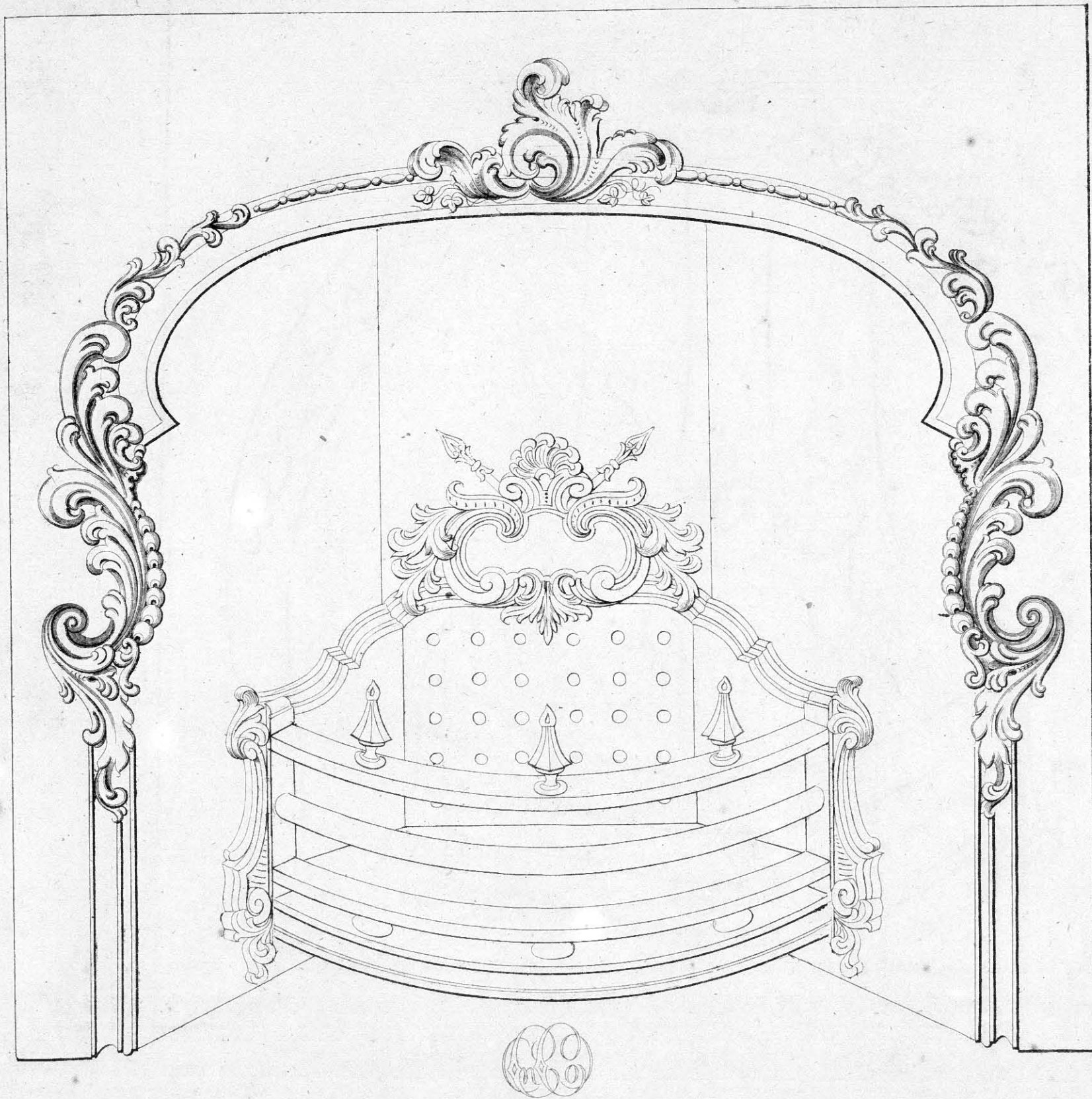

N^o 175 Front with 168 inside metal spikes & plain fret.
Sizes 30 x 36 to 42 x 42 Inches.

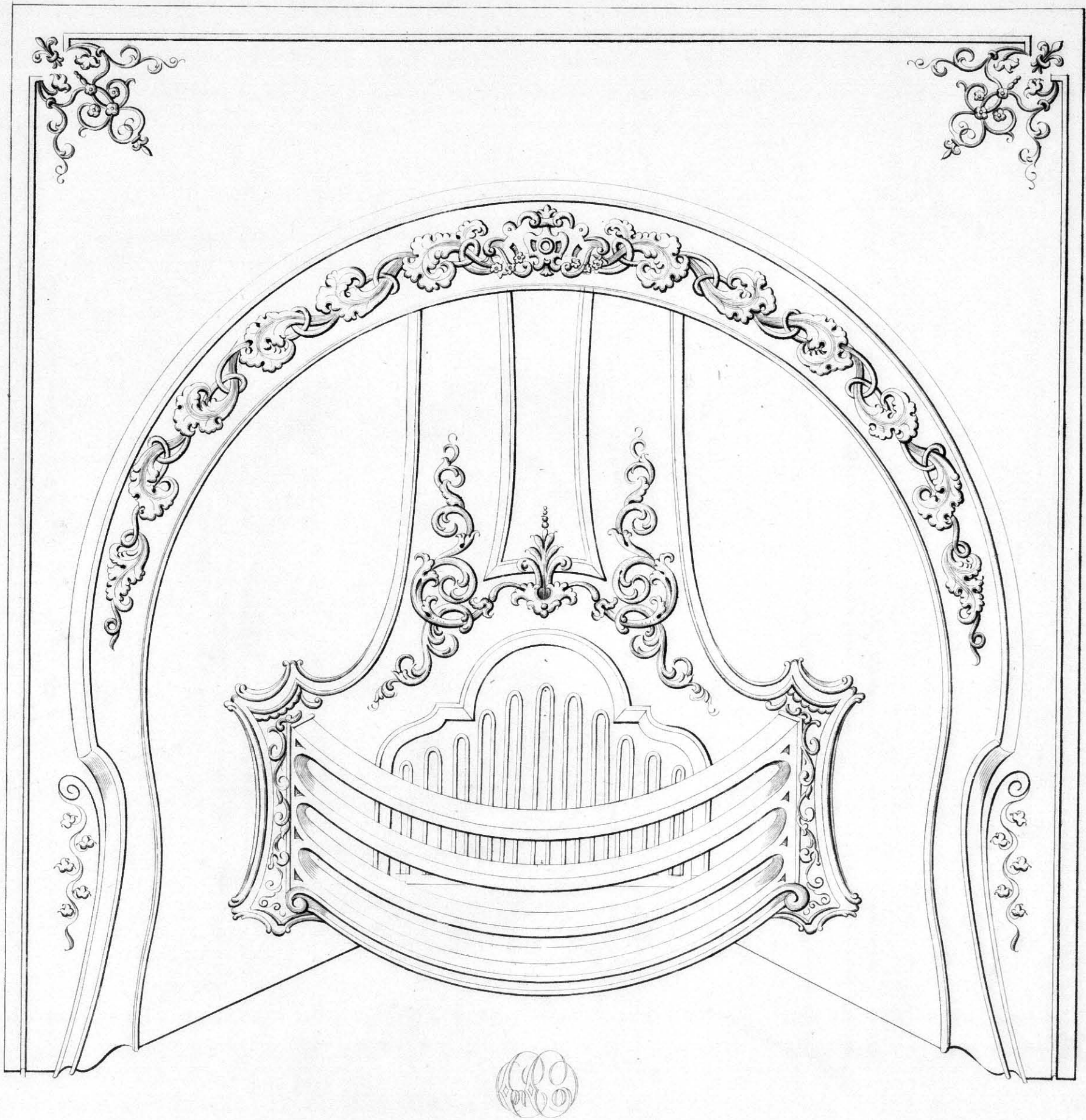

REGISTER STOVE N^o 187.

Sizes 34 x 36 - 36 & 38 x 38 ins. and up to 42 ins. Square.

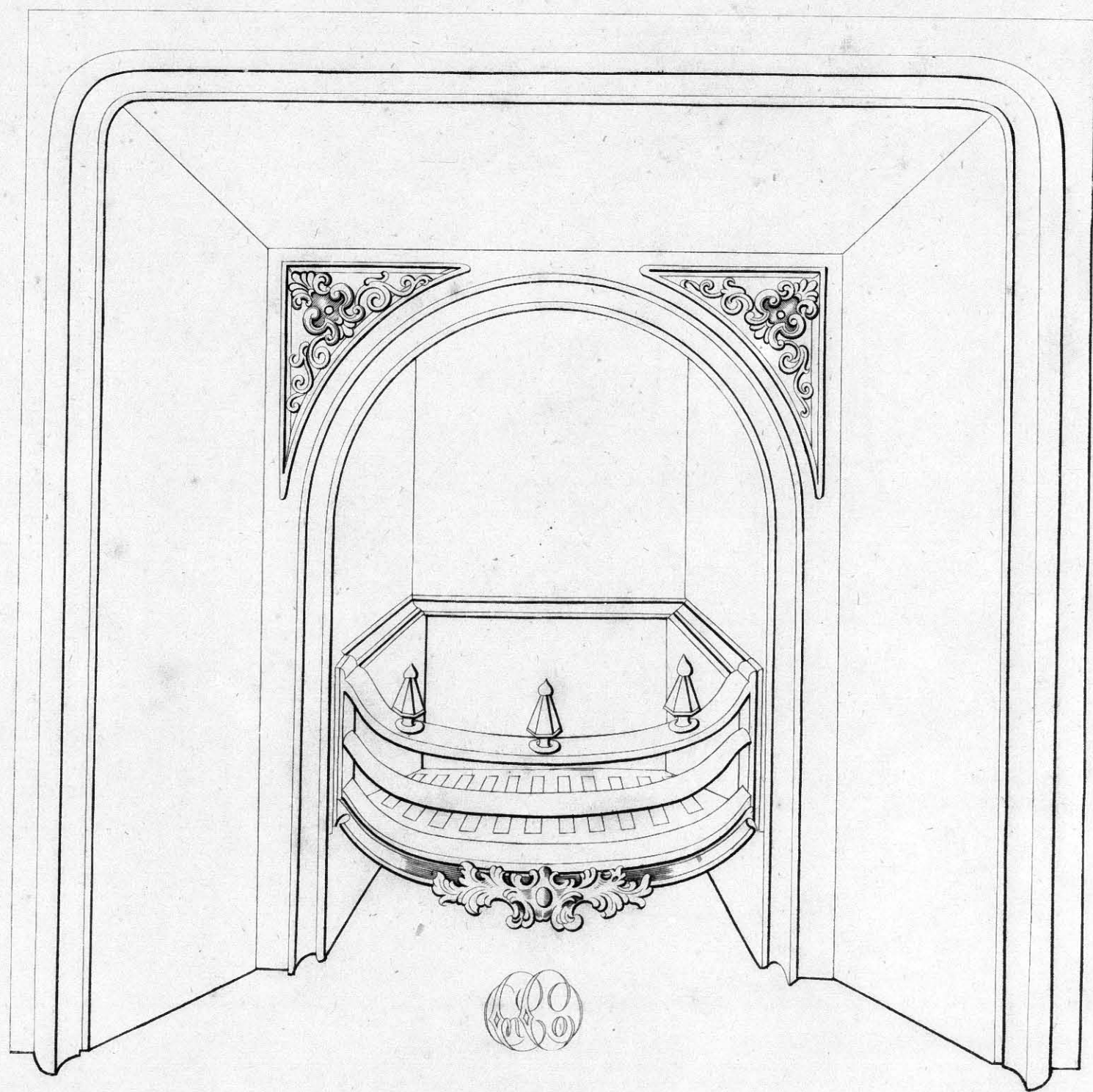

N^o 174 Kinnaird Stove
Fire brick or Iron back N^o 7 bars N^o 30 fret
Sizes 30 x 36 to 42 x 42 Inches.

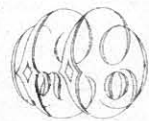
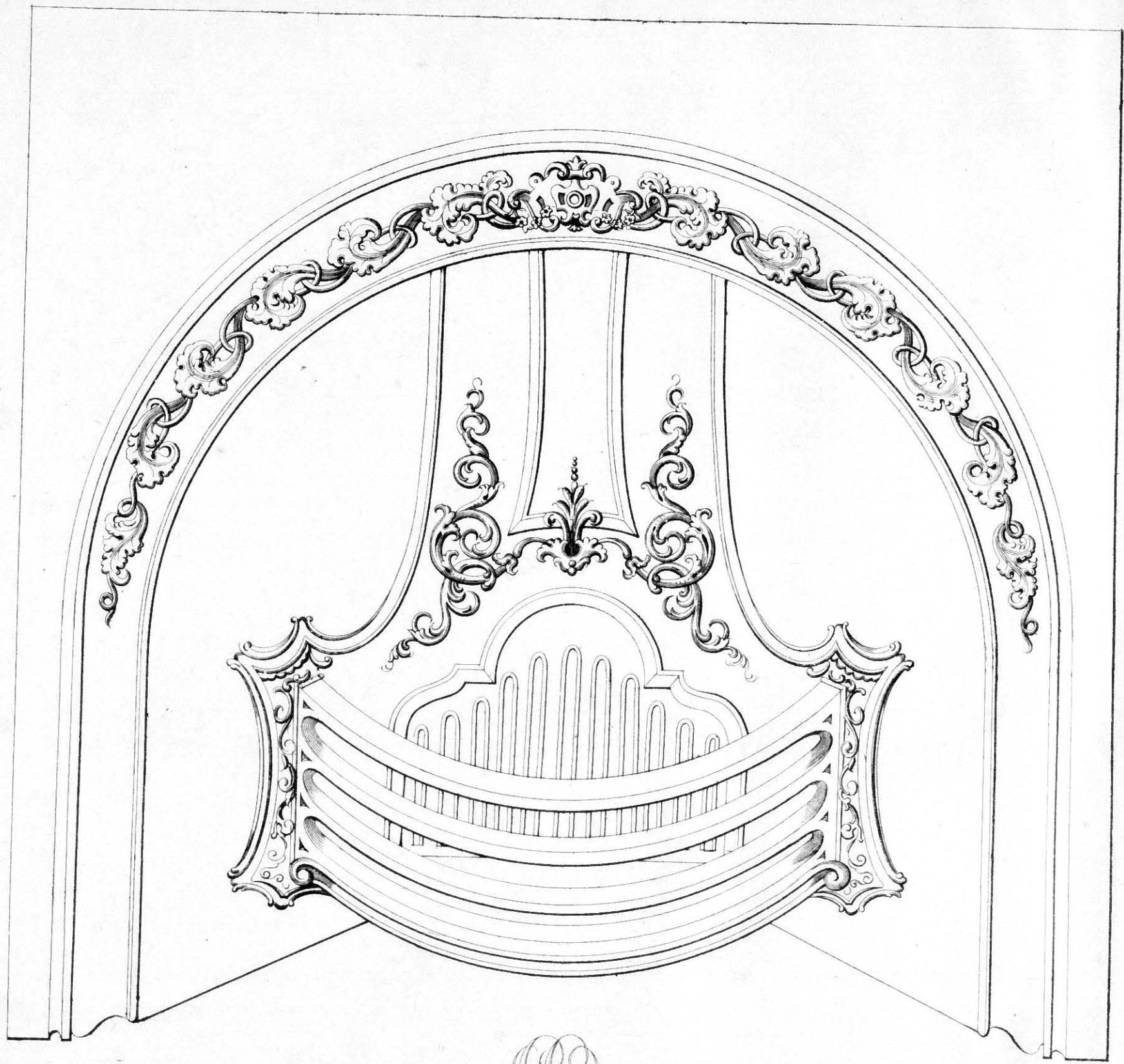

REGISTER STOVE *N°190 Front N°187 Back*

Sizes 30_32_34 x 36_ 36 & 38 x 38 ins.

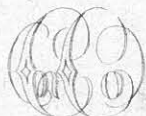
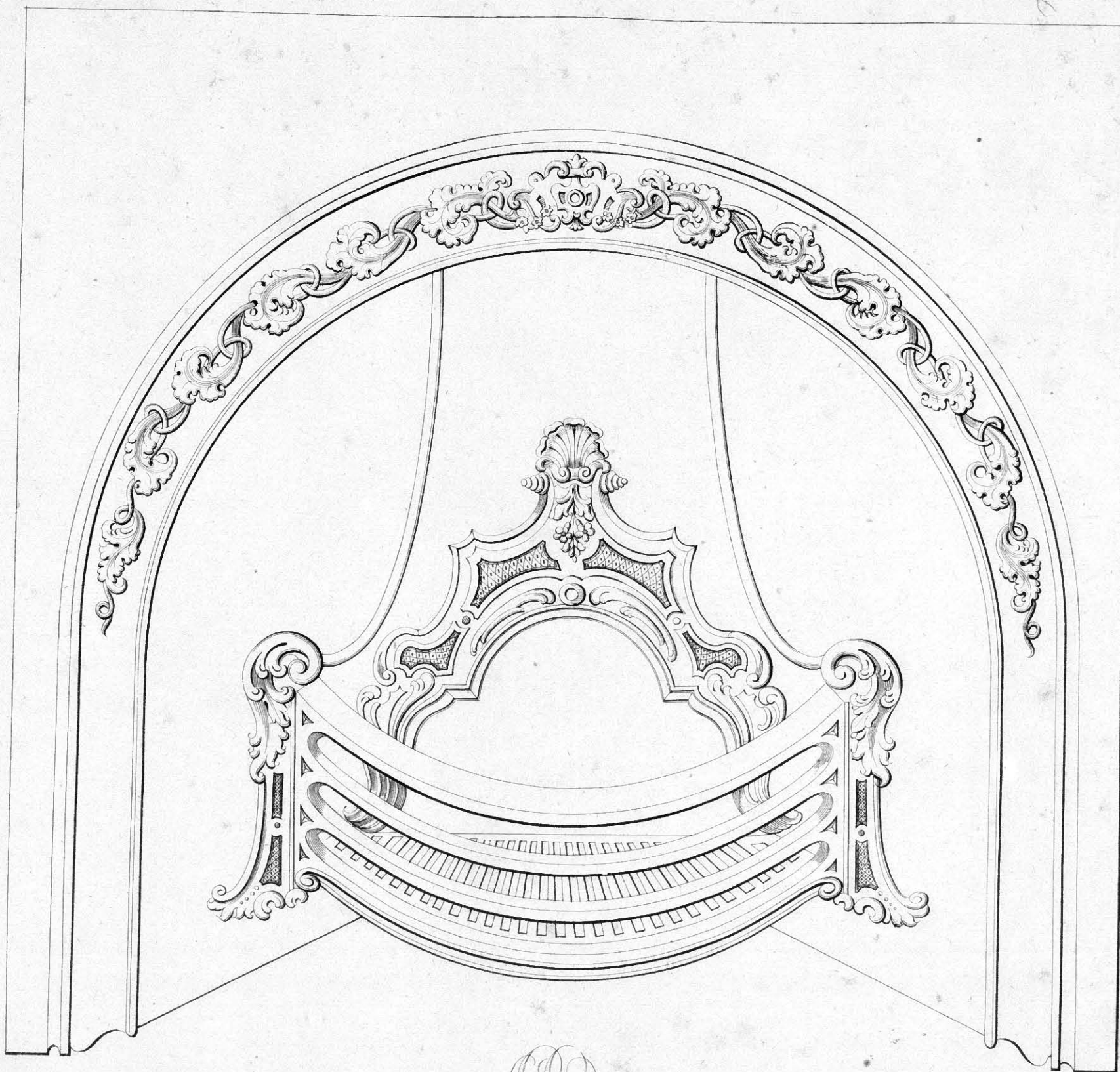

REGISTER STOVE NO 190 FRONT with 184 Back
Sizes 30 32 34 x 36 and up to 42 ins. square.

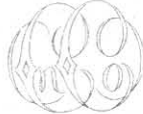
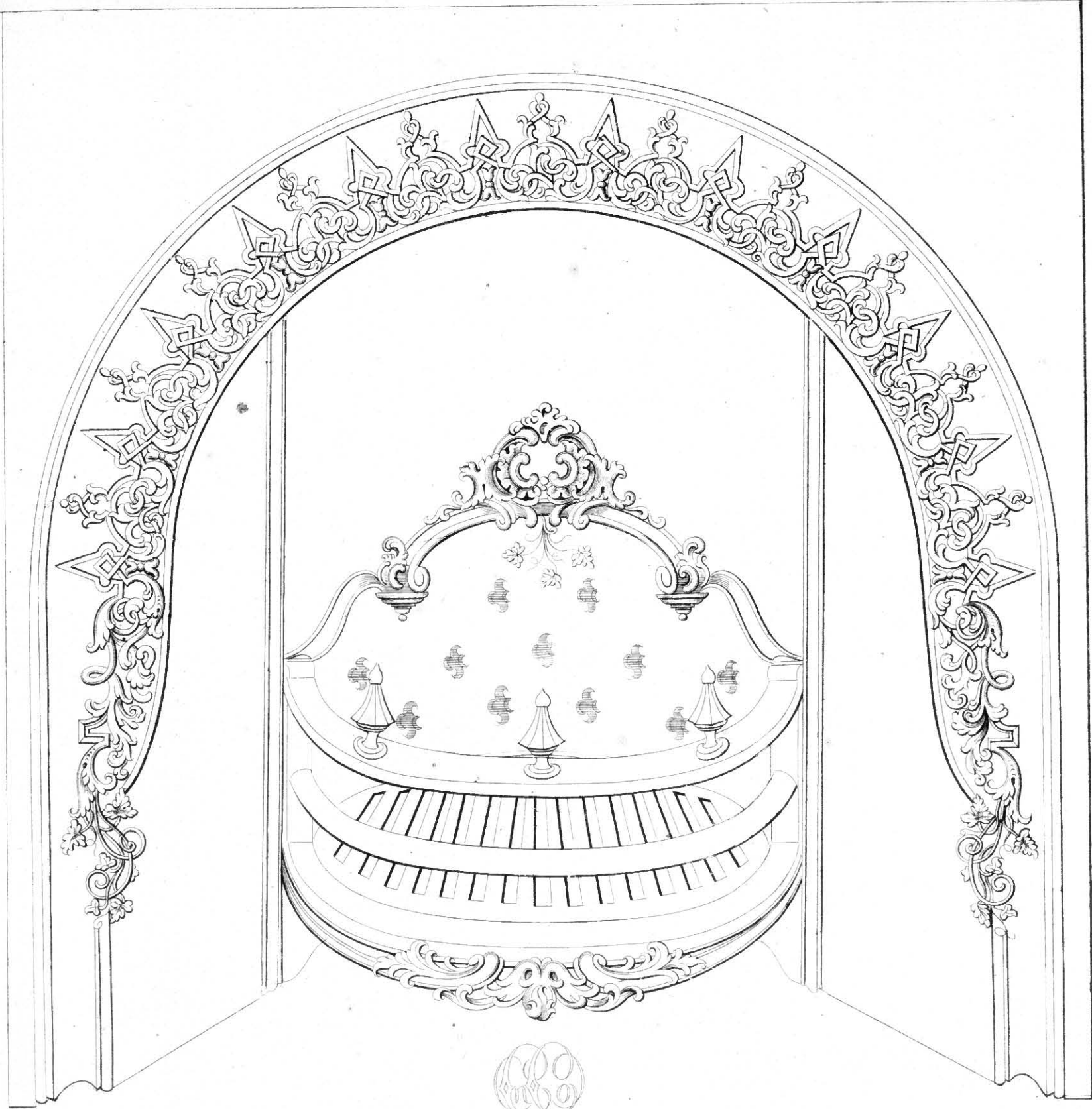

Register Stove

N^o 173 Front—N^o 4 round back—plain cheeks—N^o 7 bars

Sizes 34 x 36 to 42 x 42. Inches

Wm. & S. L. H. F.

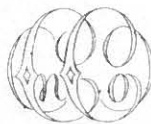
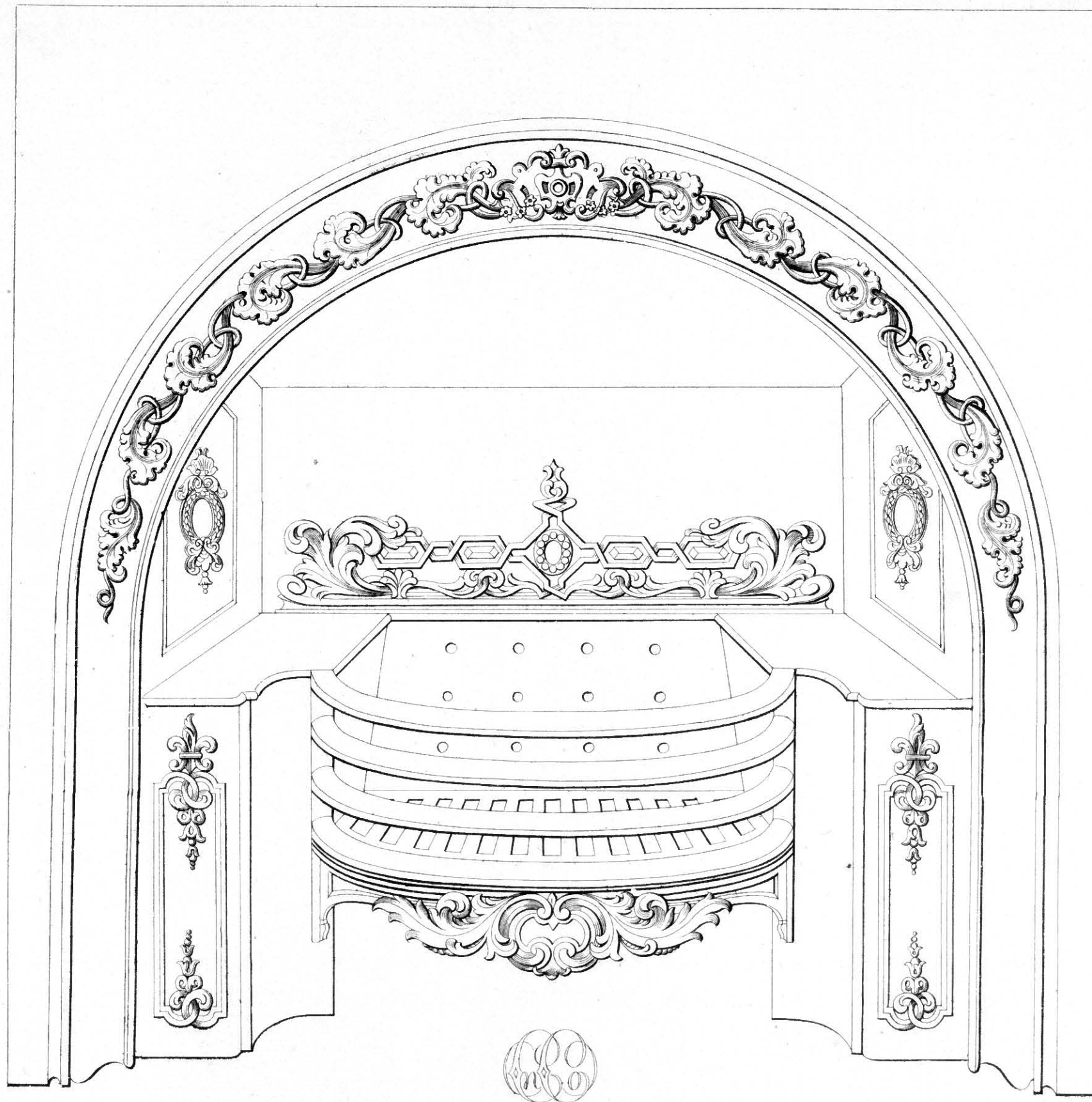

REGISTER STOVE

No 190 Front with 169 inside Metal

Sizes 24. 26. 28. 30. 32 & 34 x 36 36 & 38 x 38 ins.

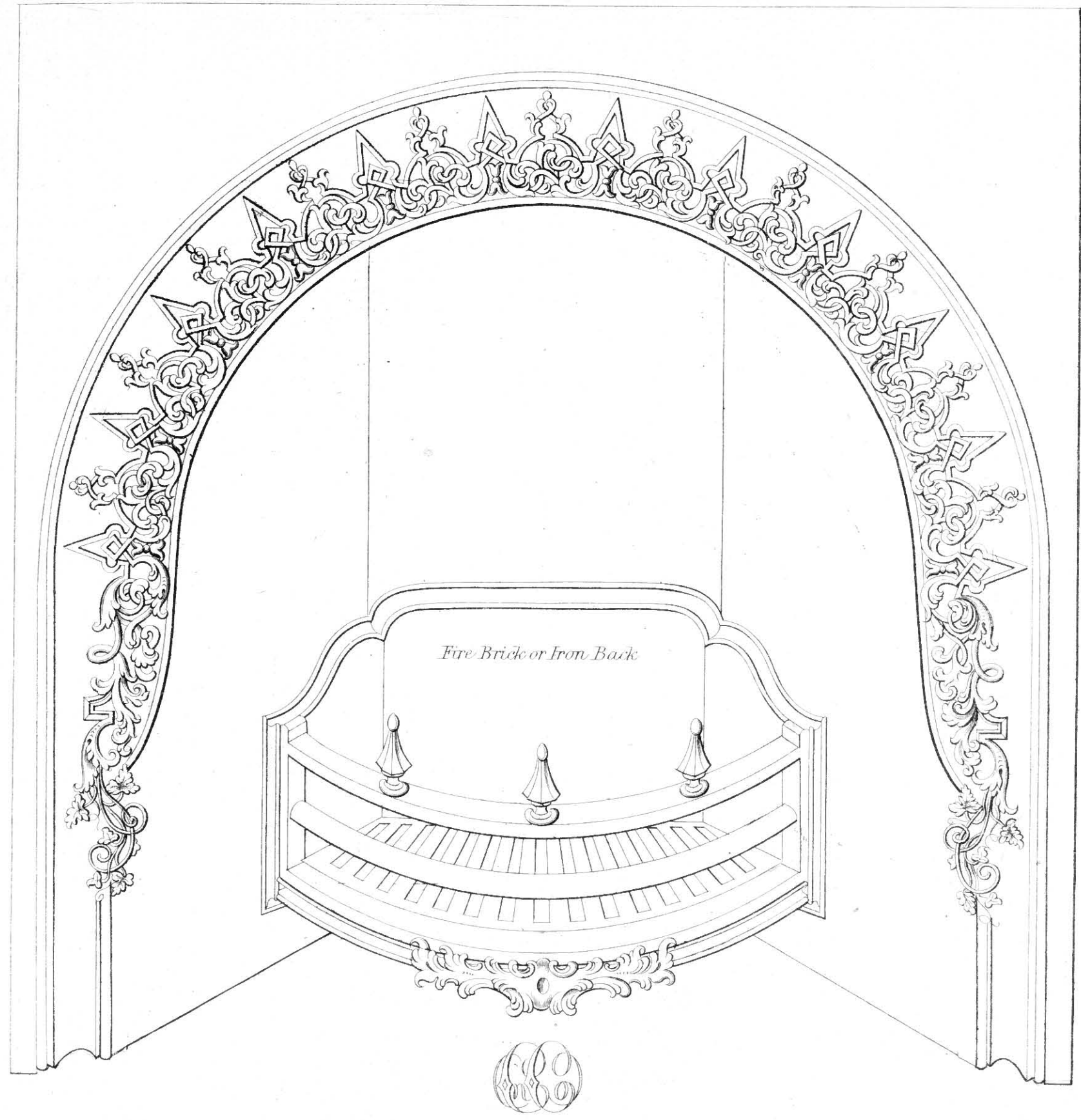

REGISTER STOVE.
N^o 173 Front N^o 8 Back and Fire N^o 8 bars.
Sizes, 34 x 36 to 42 x 42 inches.

Kimberly & Sons, Edin^g

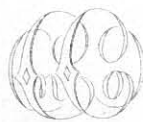
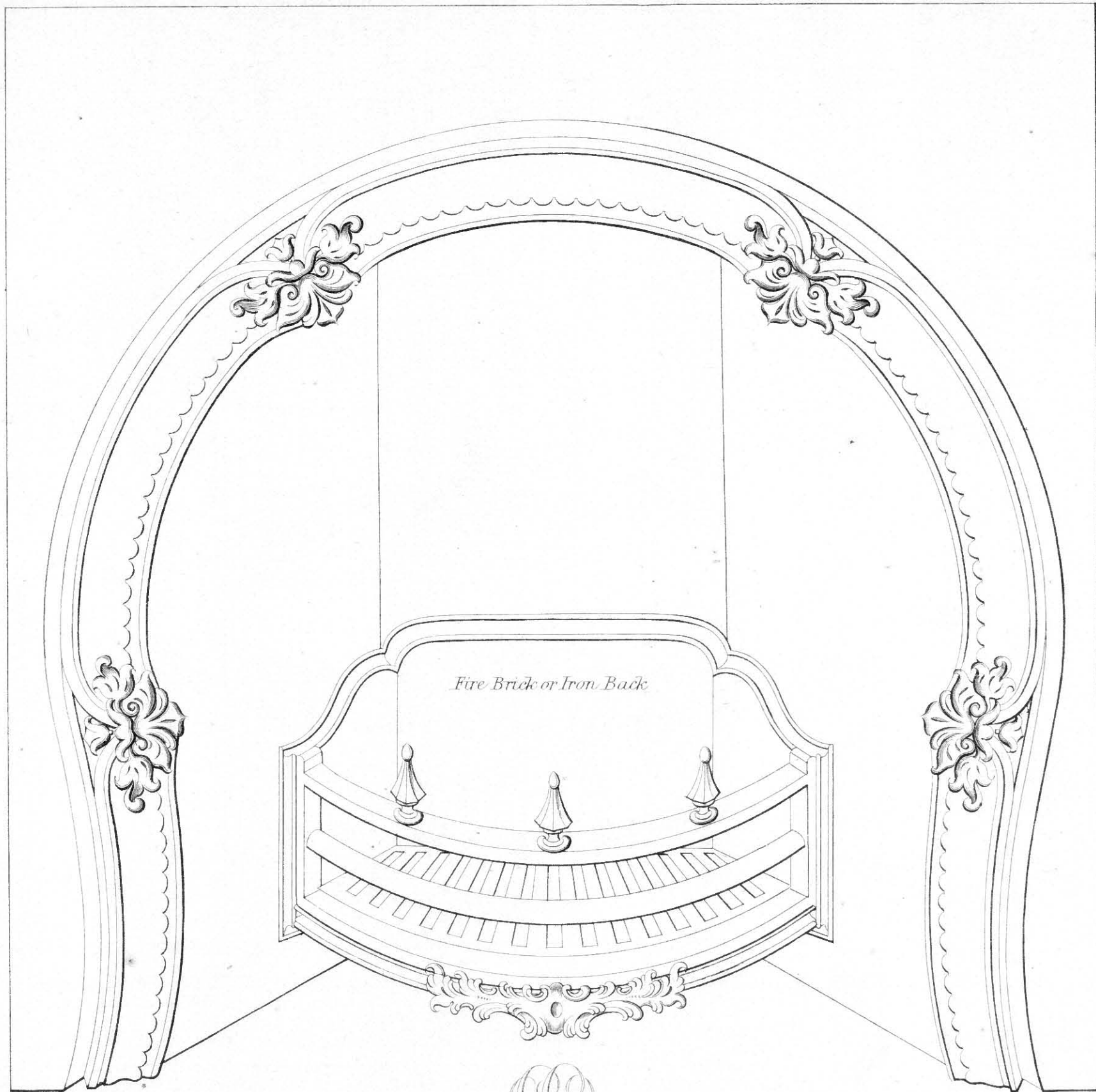

REGISTER STOVE N° 193 *N° 177 Fire*
Sizes 30-32 & 34 x 36 ins. 36 x 38 inches.

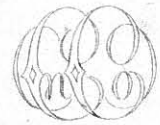
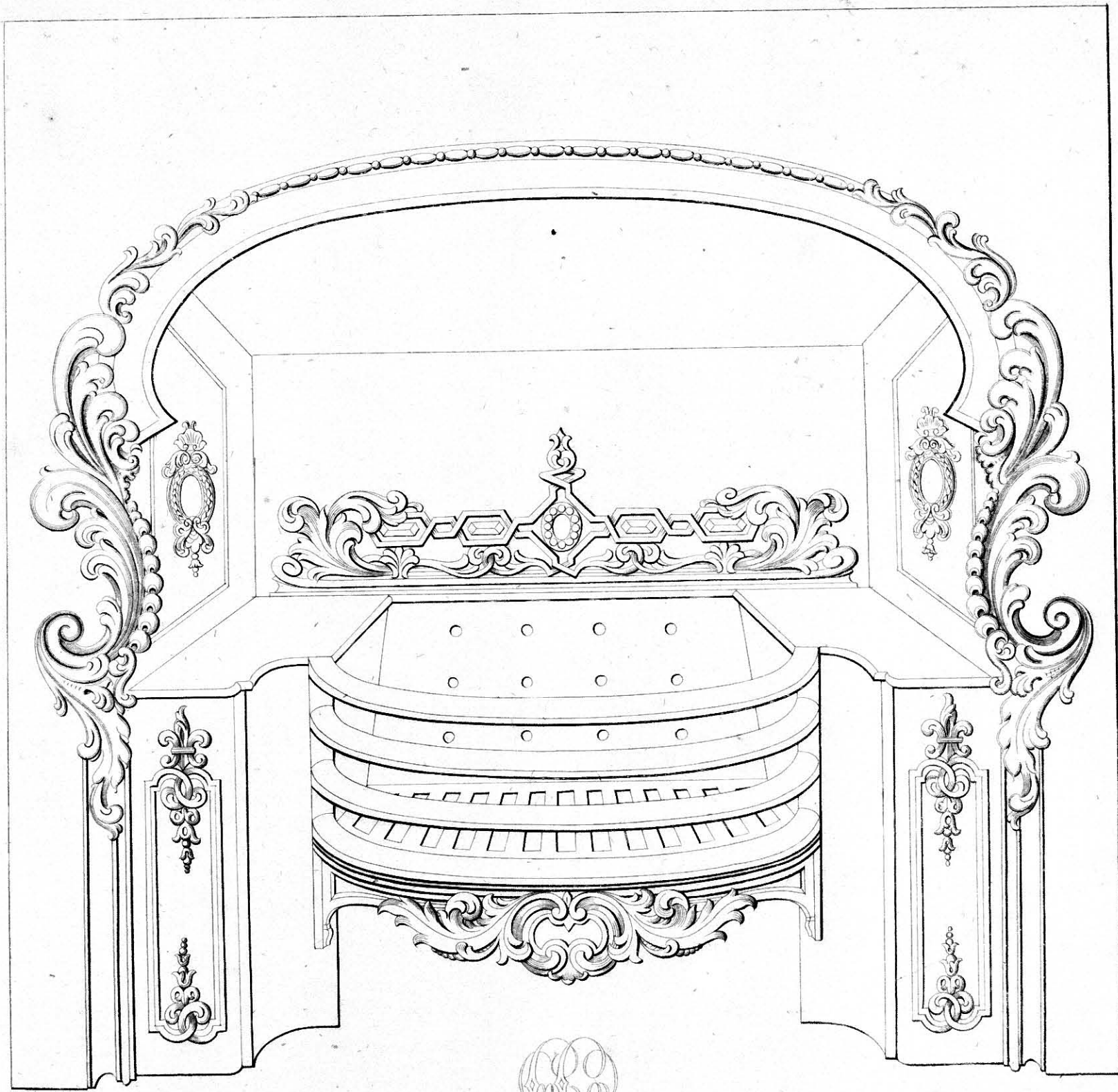

Register Stove
Nº 172 Front with Nº 169 Metal
Sizes 30-32-34 x 36 36-38 x 38 Ins.

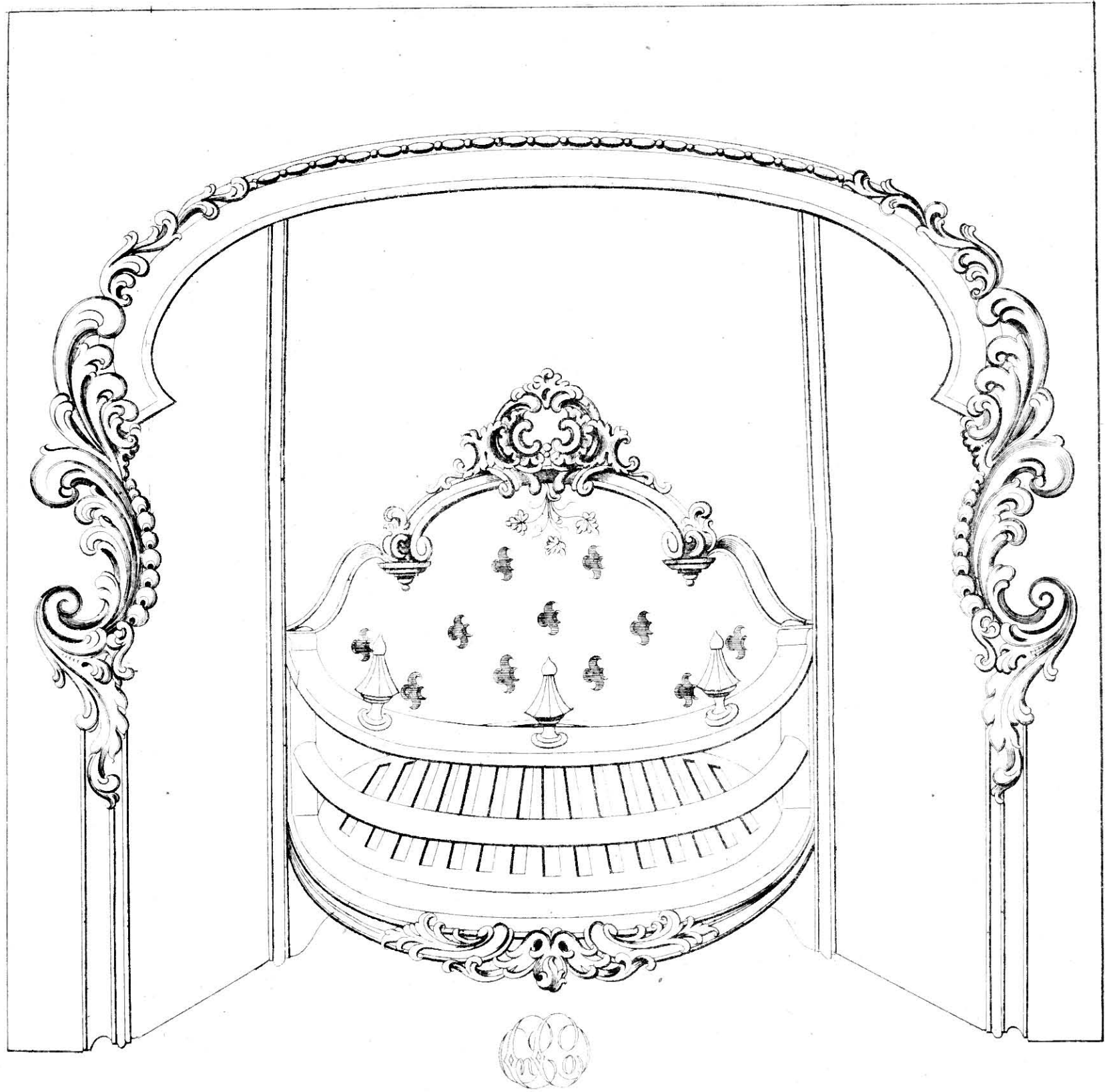

Register Stove

*No 172 Front - No 4 round back - plain checks - No 7 bars
Sizes 30 32 34x36 ins 36 & 38 x 38 ins*

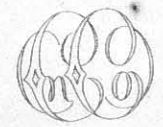
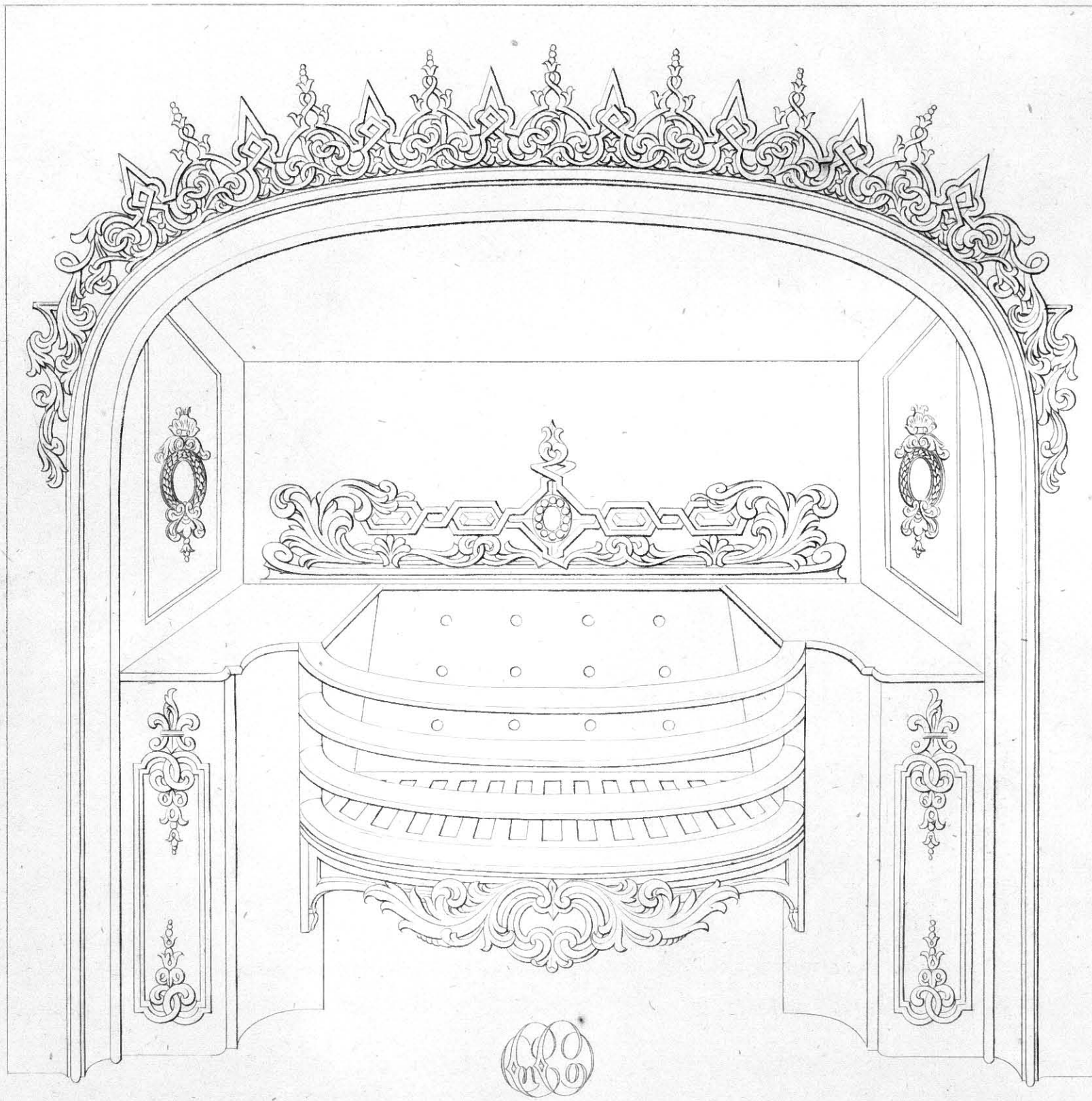

Register Stove
N° 169 Front with N° 169 Metal
Sizes 30-32-34 x 36. 36-38 x 38 Ins.

Bed Room Register Stoves

— Fitted only —

PLATE 30

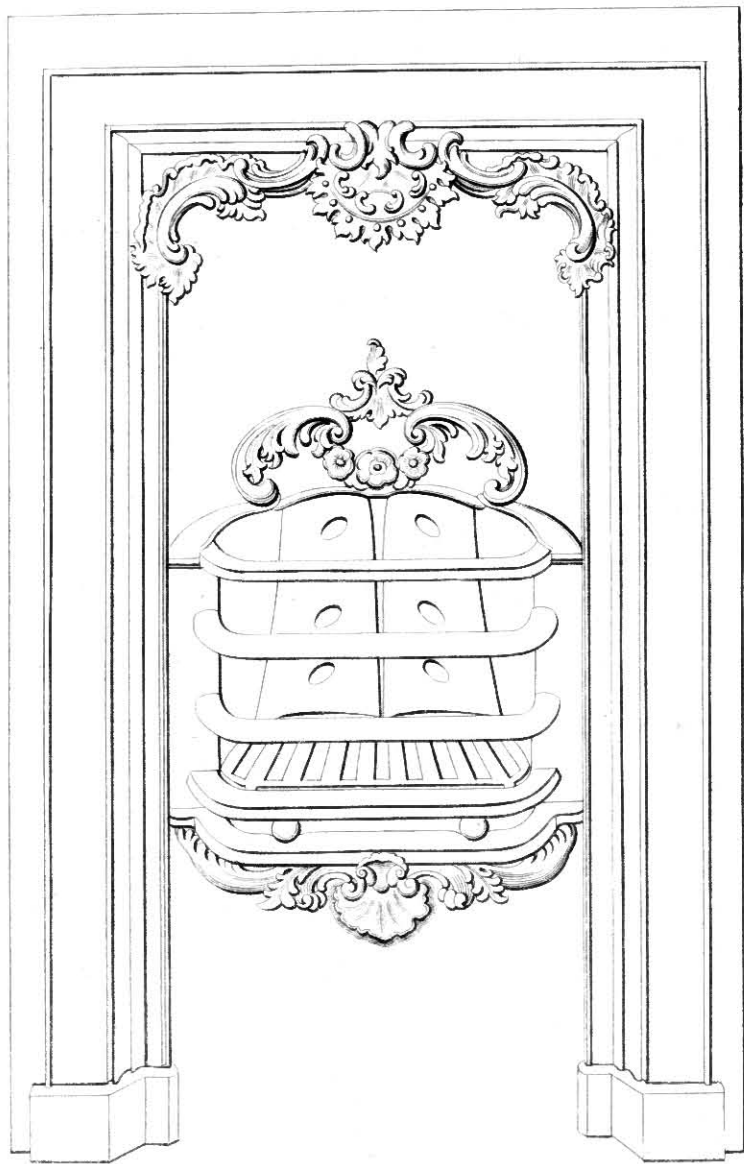

*This Pattern— 16, 18, 20, 22 x 34 ins. high,
and these sizes only*

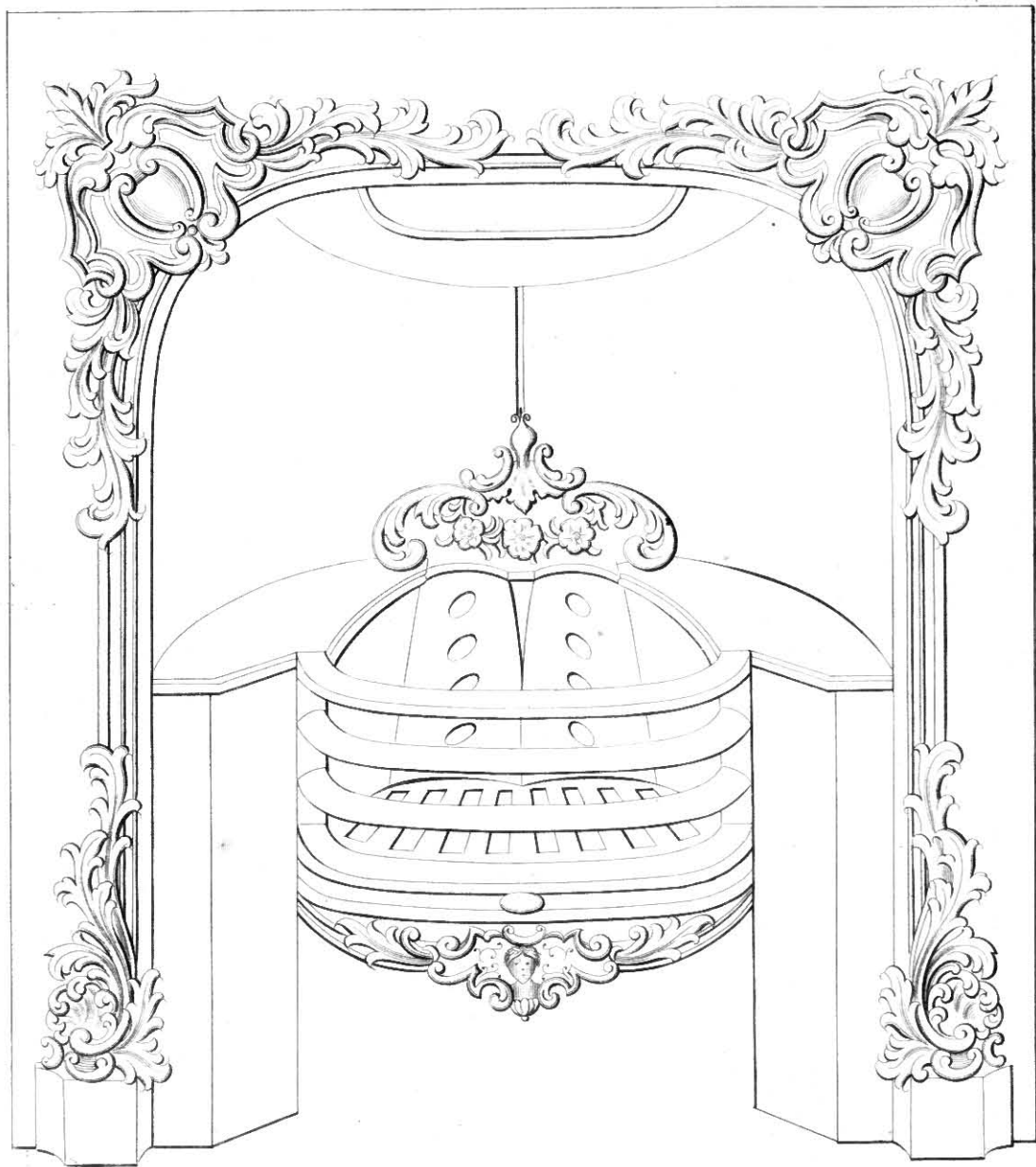
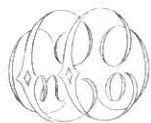

*This Pattern— 24, 26 x 36 ins. high,
and these sizes only.*

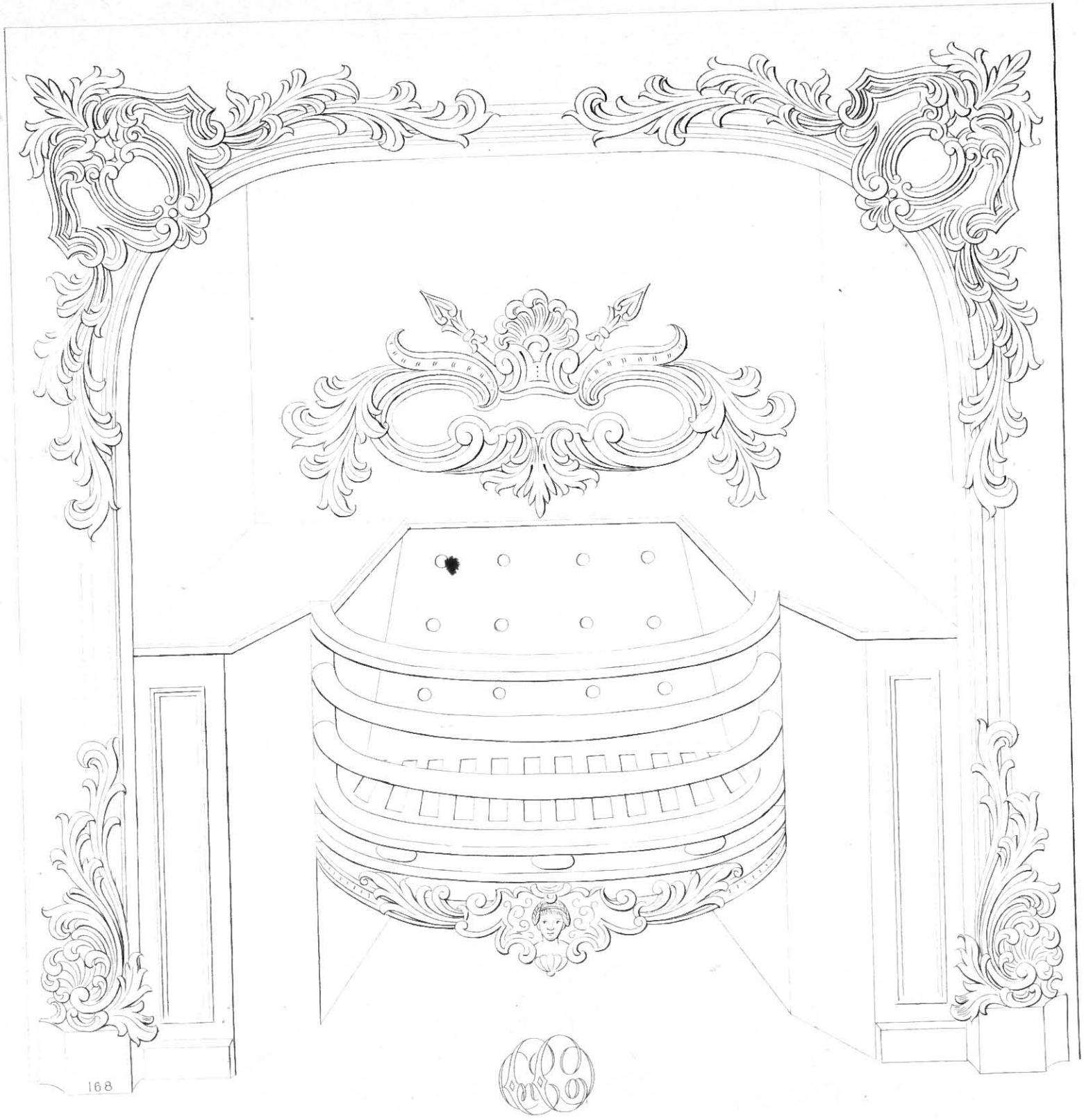

168

Recess Register Stove, N^o 168 Front, N^o 9 Back, N^o 29 Fret.

----- Sizes 30_32 and 34 by 36 ins. 36 and 38 by 38 ins.

Angle Cheek Reg^r Stoves, 32_34 by 36 ins. 36 and 38 by 38 ins. } Can also be had with this Front & Fret.
and R. E. Reg^r Stoves, 24_26_28_30 and 32 by 36 ins. ----- }

N. 168 Register Stove

PLATE 32

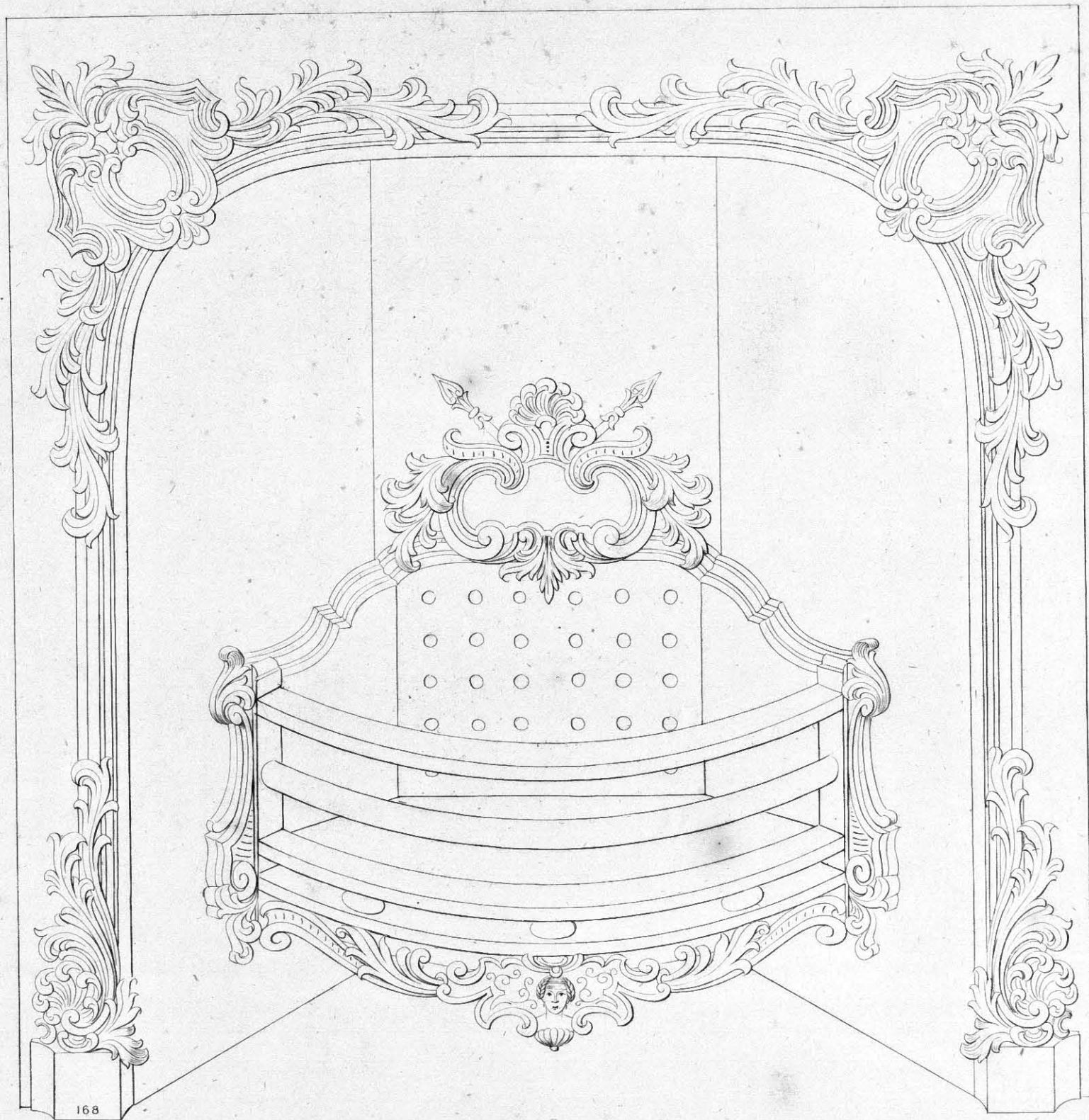

*Sizes from 34 ins. to 42 ins. wide by the usual height.
With fire brick or Iron back and either ground or unground cheeks*

N. 166. Register Stove with Open Hobs.

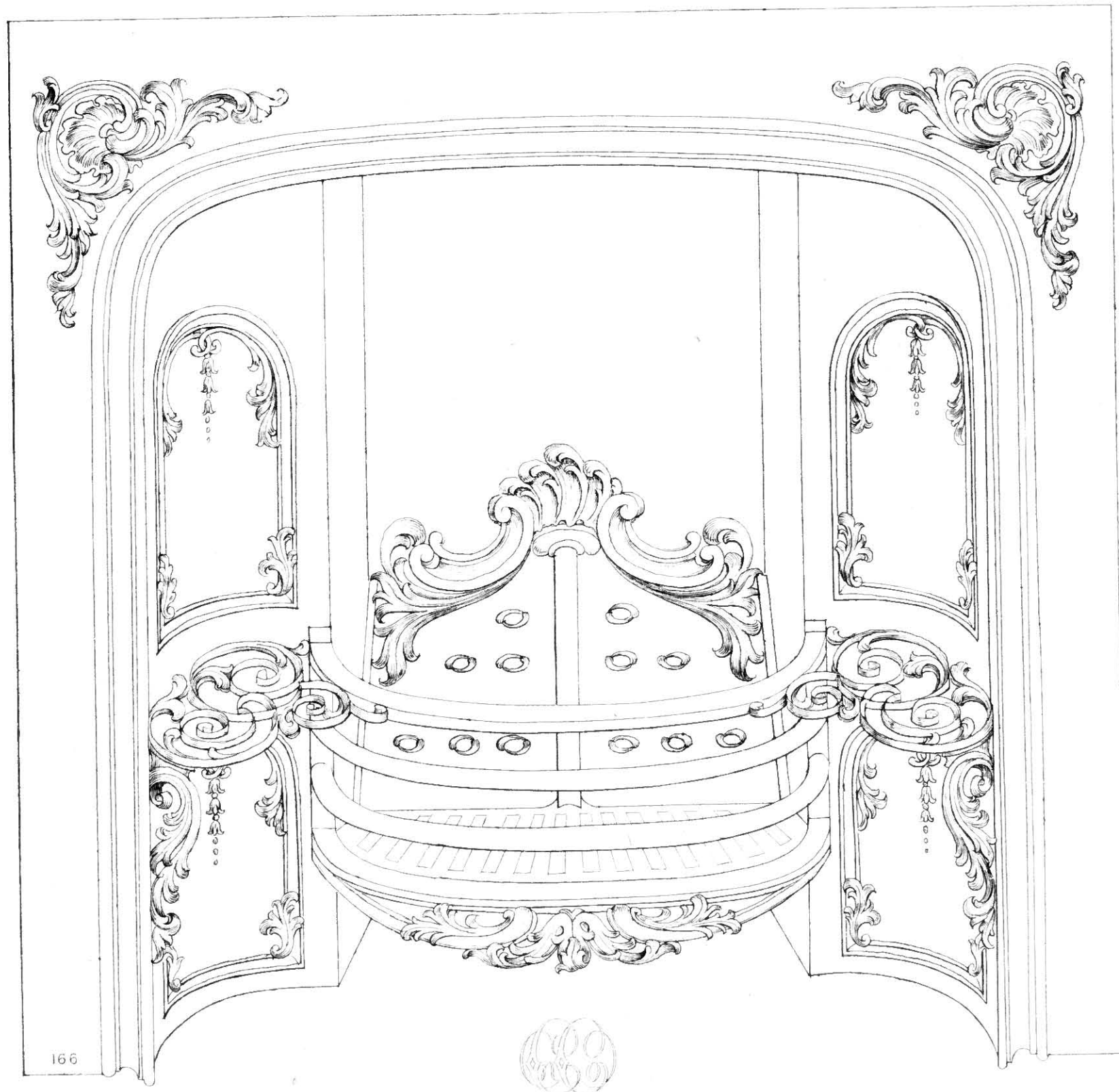

166



Sizes 28, 30, 32, 34, 36 ins. wide by 36 ins. high, and 38 ins. square.

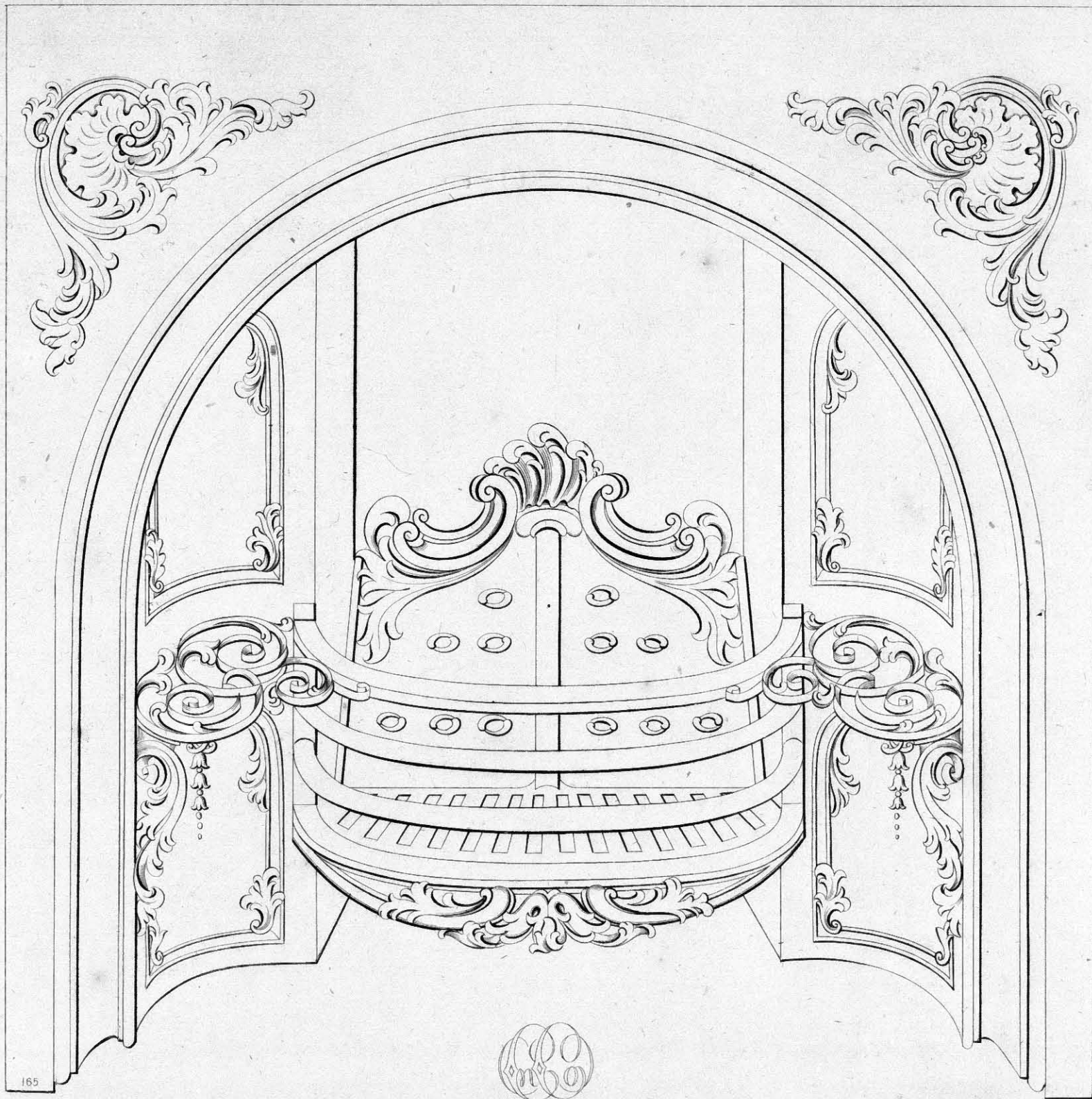

N^o 165 Front with N^o 166 Inside Metal.
Sizes 34 by 36 36 and 38 by 38 ins.

Eng.^d by Kirkwood & Son Edin^g.

N. 165 Register Stove

PLATE 35

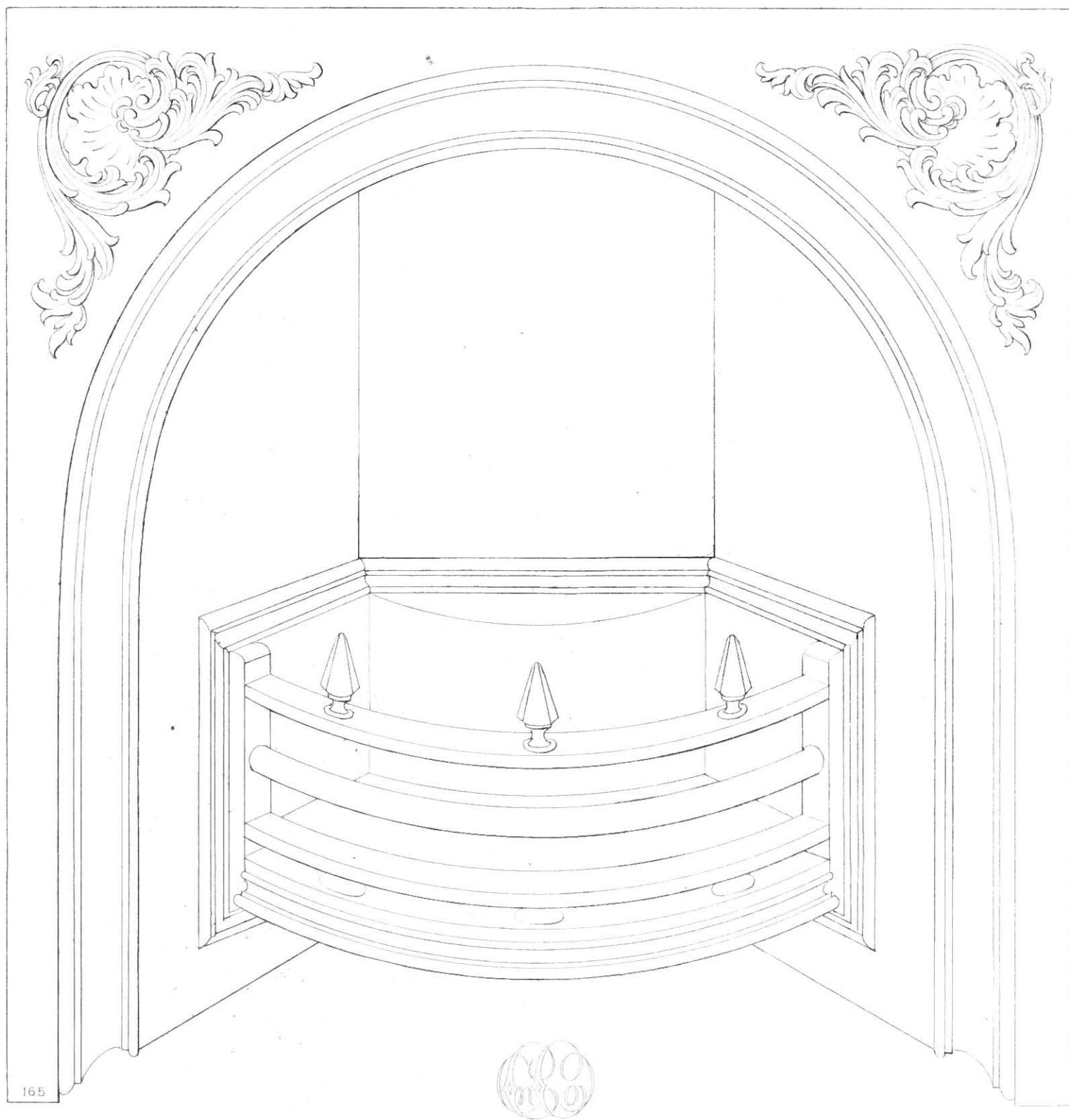

165

With or Without Fire Bricks
Sizes 34 x 36 - 36 & 38 x 38 Inches.

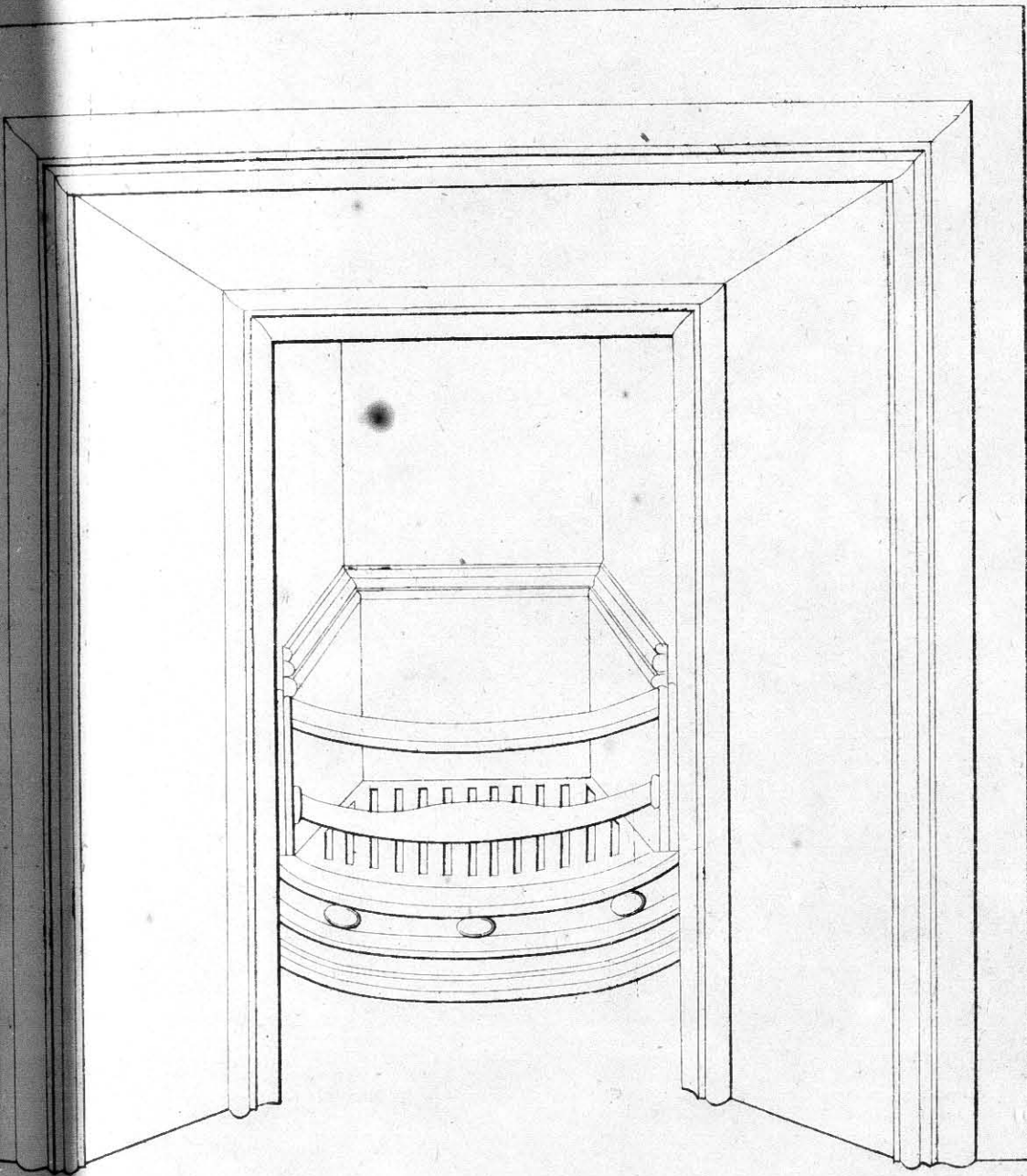

BRUCE REGISTER STOVE NO 1

Sizes 34 x 36 36 & 38 x 38 In. Fitted only.

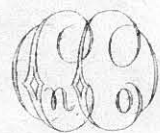

Kirkwood & Son, Edin

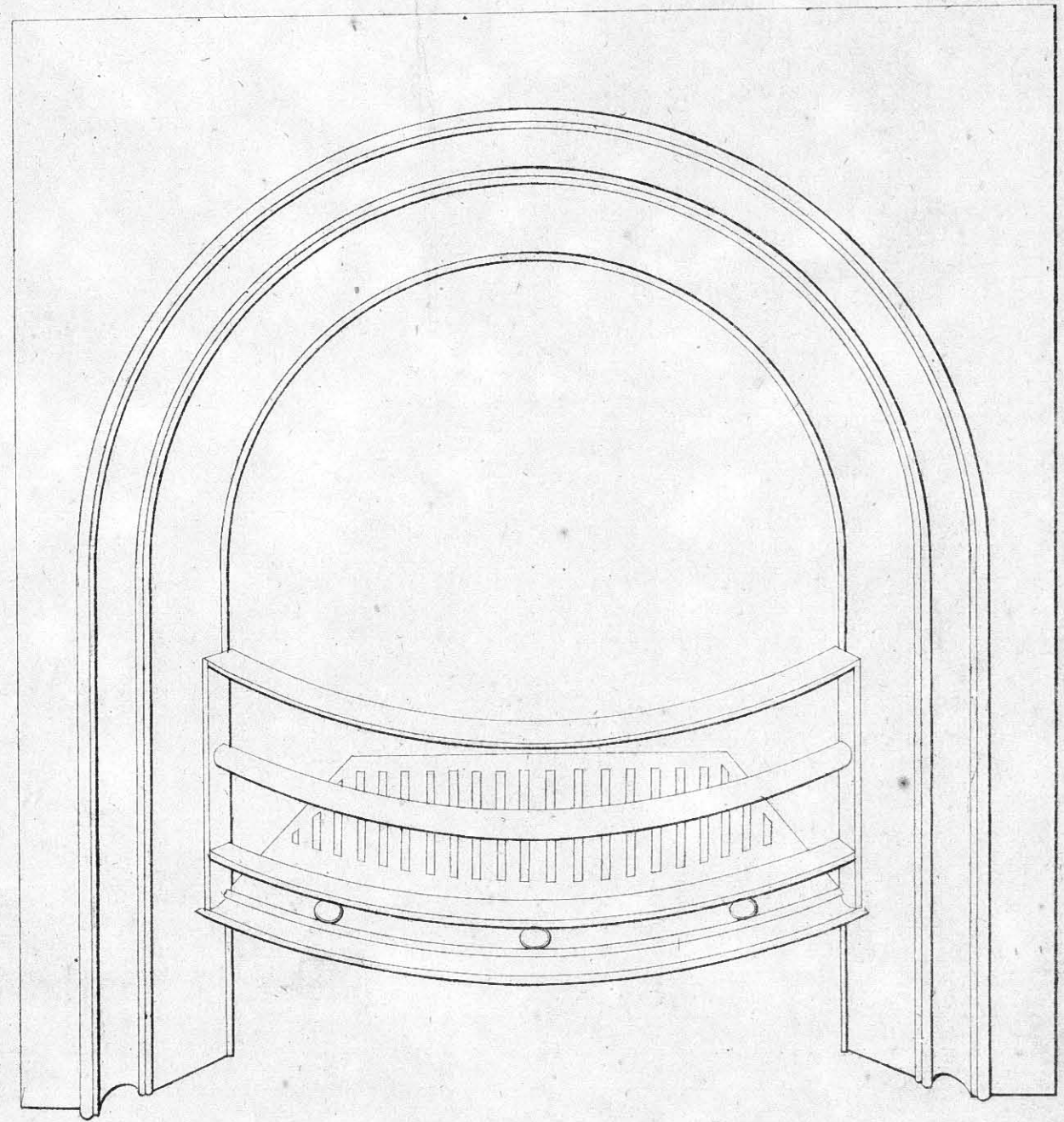

SHAM REGISTER STOVE
No 165 Front with Bottom Grate

Sizes 24 26 28, 30, 32, 34 x 36 & 36 x 38 In.

N. 161 Register Stove

PLATE 37

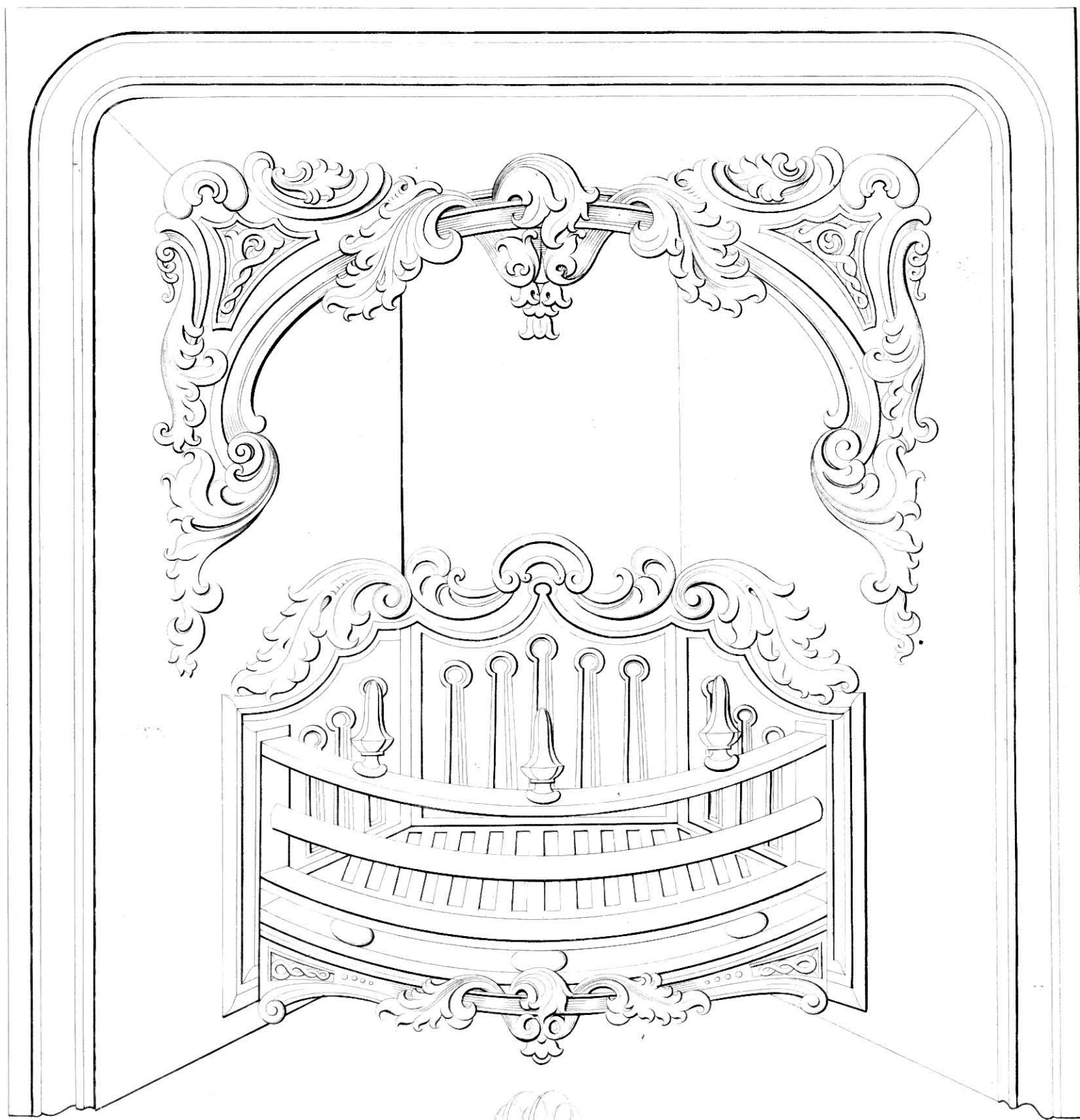

With N^o 161 Front ground. Ground straight Checks with Lintel ornament.

Sizes 34 x 36 - 36 & 38 x 38 Inches.

Eng^d by Kirkwood & Son Edin^r

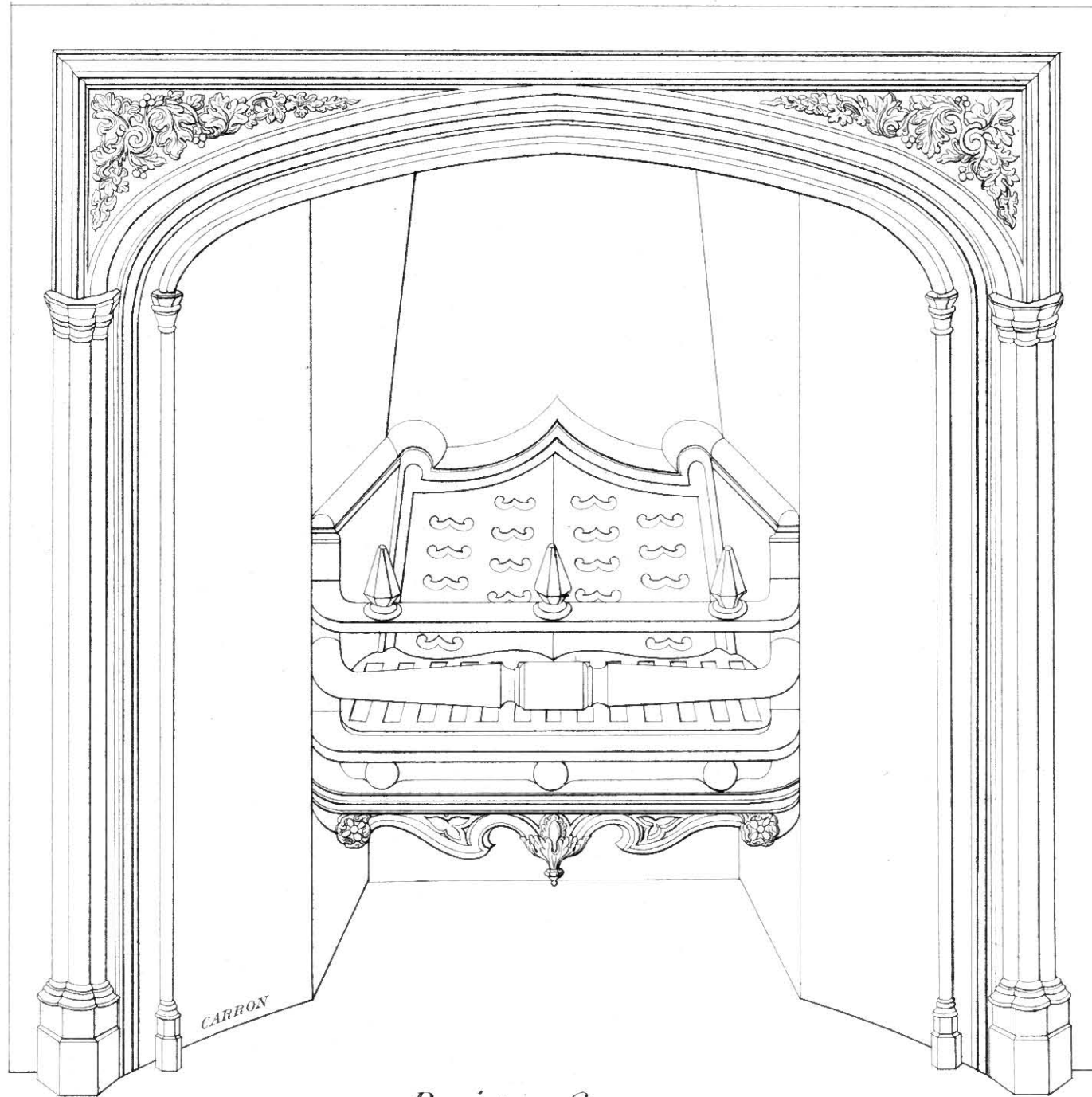

Register Stove,

With N.º 133 Front, ground Checks N.º 4 inside Back

& C. Bars with Gothic Fret

Sizes 32 x 36, to 42 x 42 inches.

*Maclure & Macdonald Lith^{rs}
Glasgow.*

*R. E. Register Stove,
with N.º 144 Front, Plain Covings & N.º 9 Fret.*

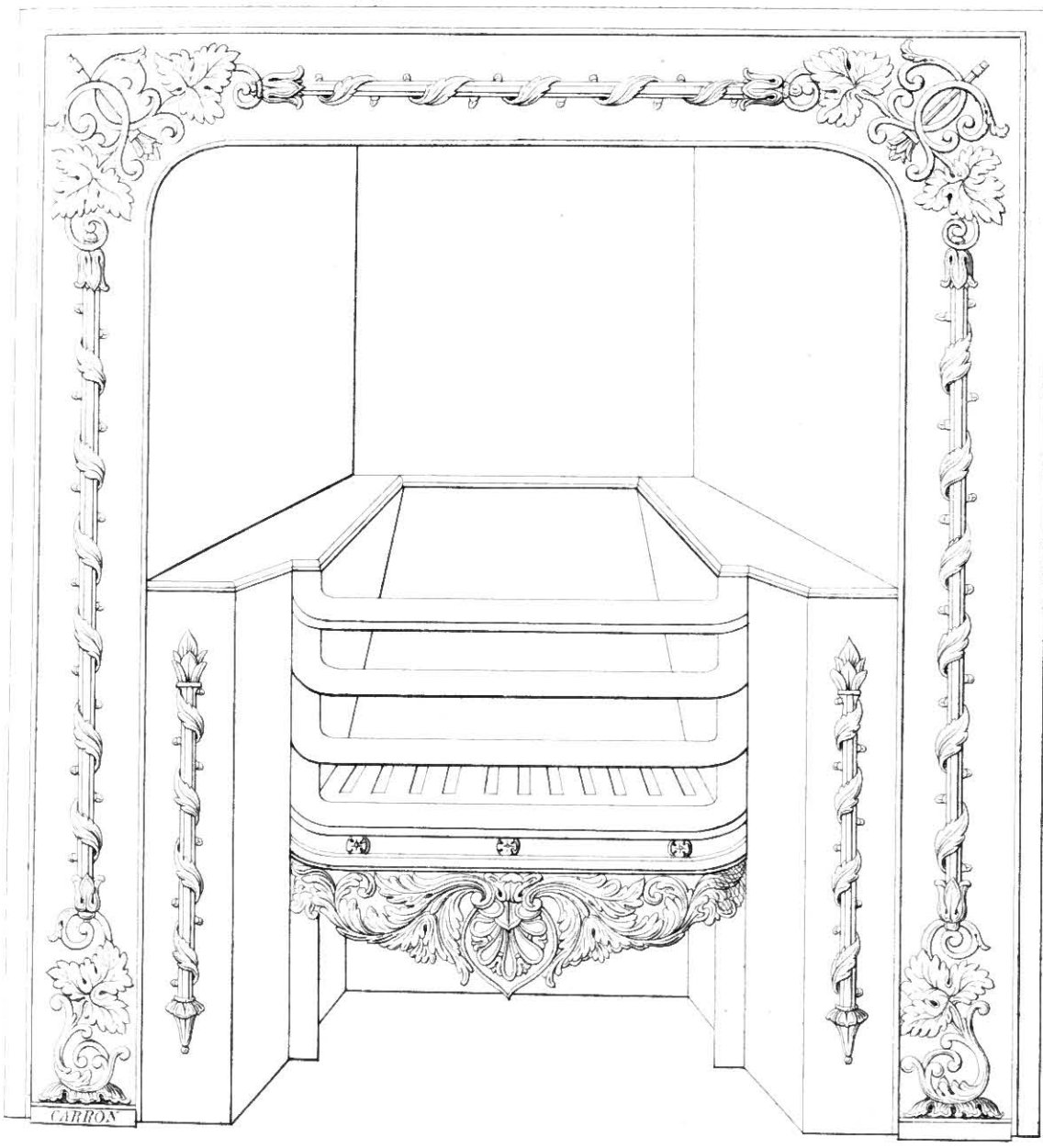

Sizes 24 x 36 to 32 x 36 Inches.

*R. E. Register Stove,
with N.º 138 Front, N.º 5 Covings & N.º 9 Fret.*

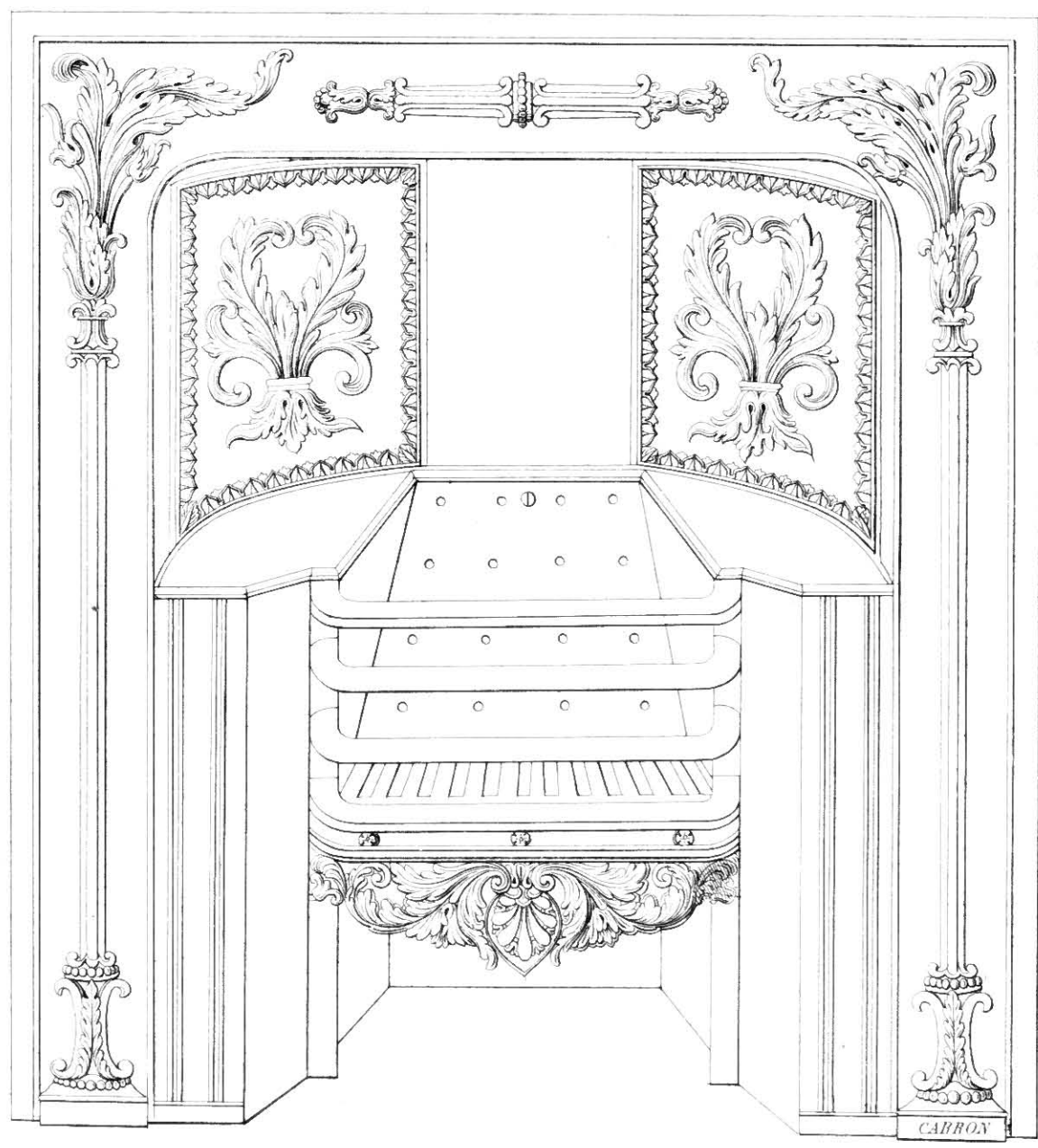

Sizes 24 x 36 to 32 x 36 Inches.

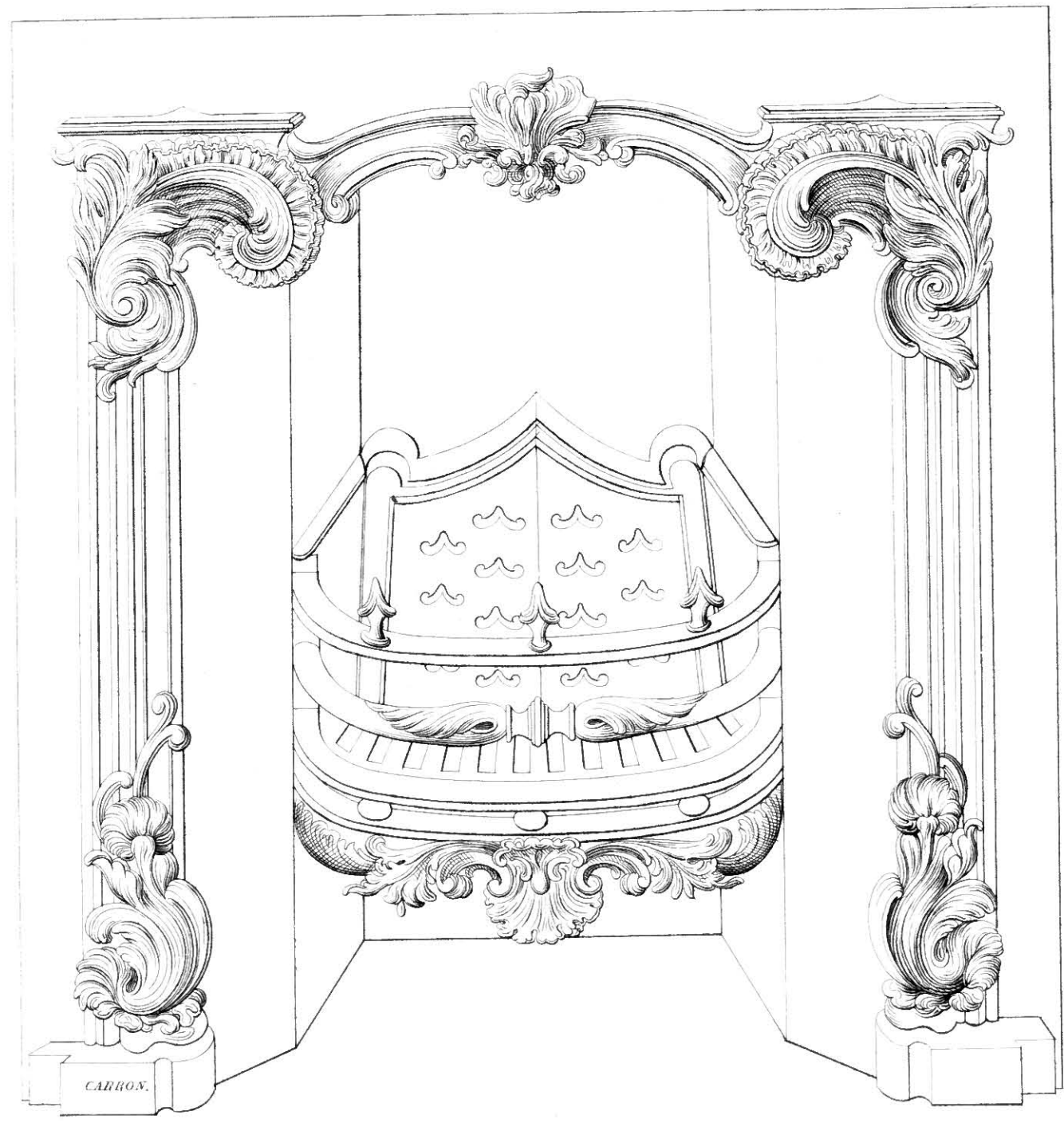

CARRON.

*Register Stove,
With N^o 146 Front, Ground Checks, N^o 4 inside Back
& O.E. Bars with N^o 20 Fret
Sizes 33 x 36 to 42 x 42 inches.*

Maclure & Macdonald Lith^{rs}
Glasgow

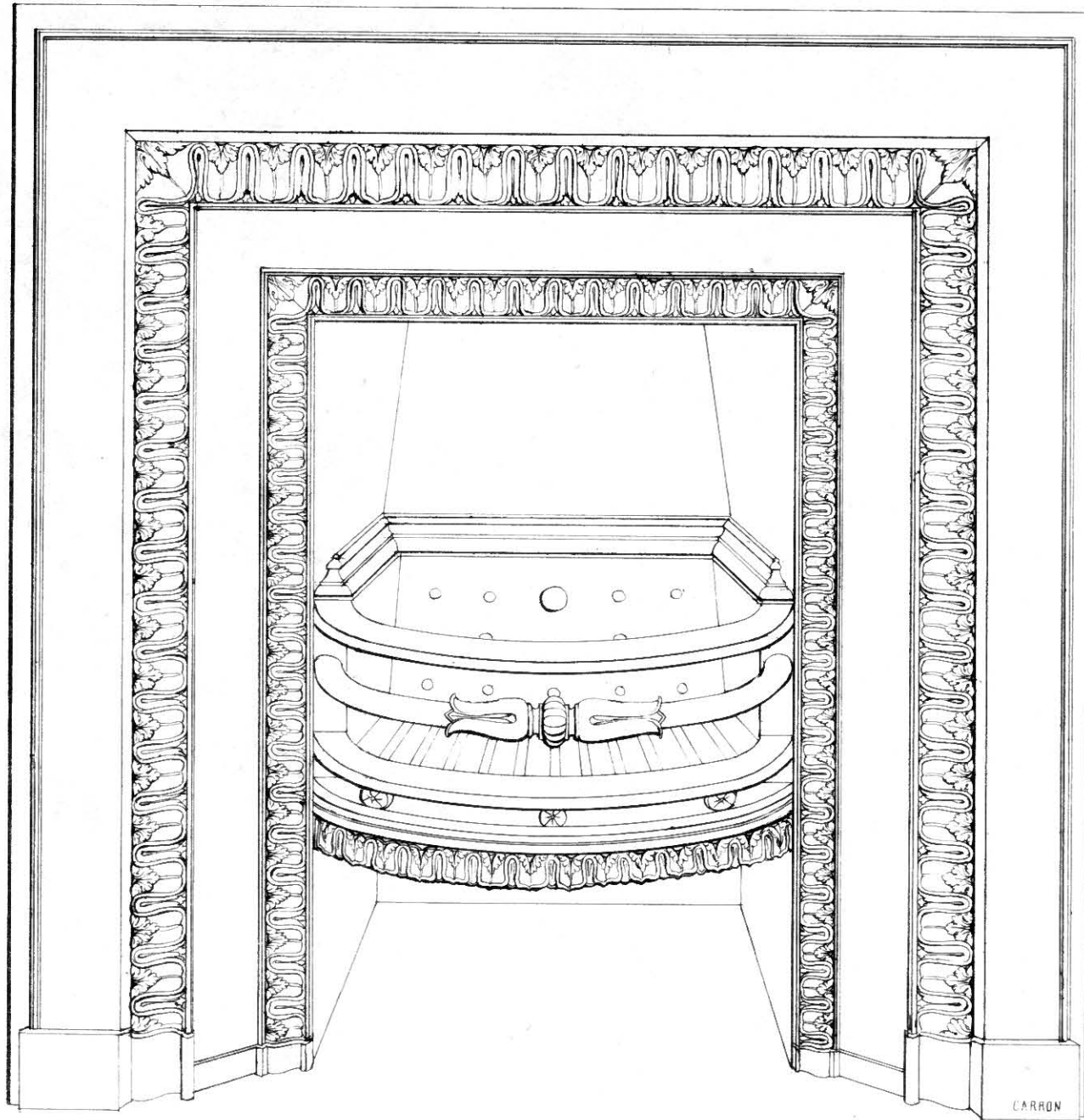

CARRON

Register Stove, N^o 150.

Sizes 24/30 to 40/40 inches

Maciure & Macdonald, lith^{rs}

57 Buchanan St

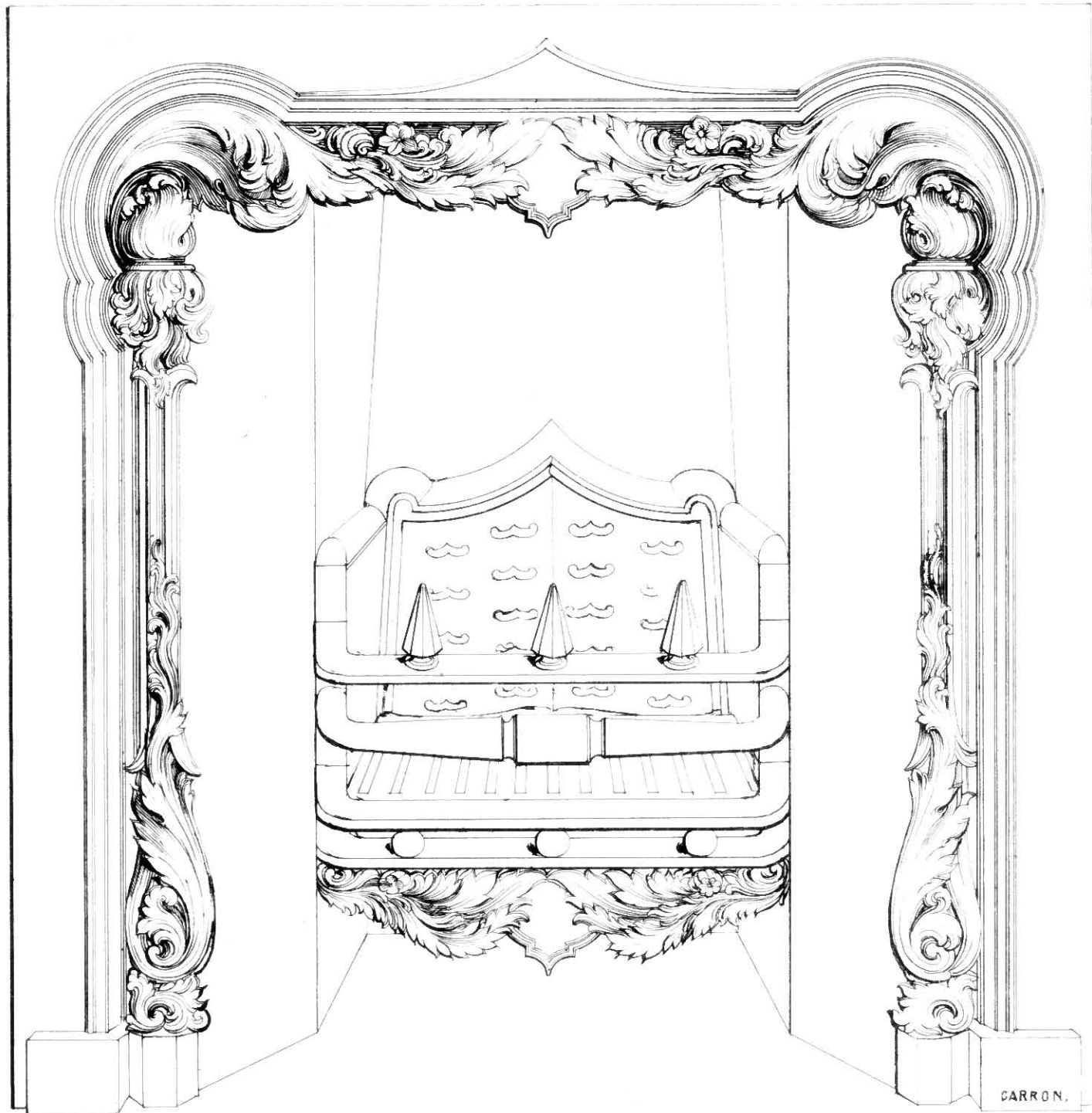

CARRON.

Register Stove N° 7.

*with Ground Checks, N° 4 inside Back & C Bars, with
N° 14 Fret.*

Sizes 34 x 36 to 42 x 42 inches

Maclure & Macdonald, 5th St. Glasgow.

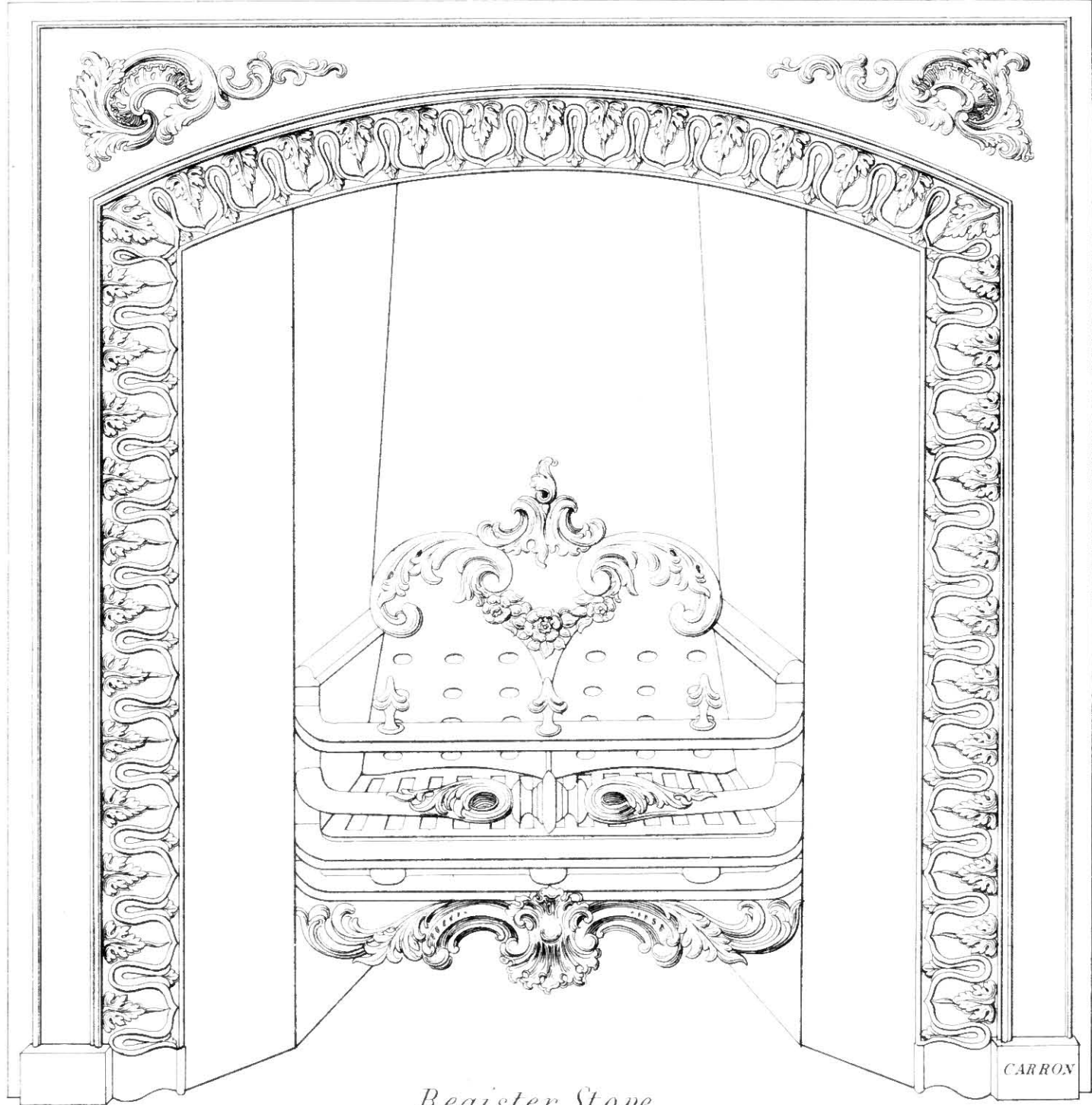

Register Stove,

With N^o 6 Front, Ground Checks, N^o 5 inside back,

& F. Bars with N^o 20 Fret.

Sizes 33 - 36, to 42 - 42 Inches.

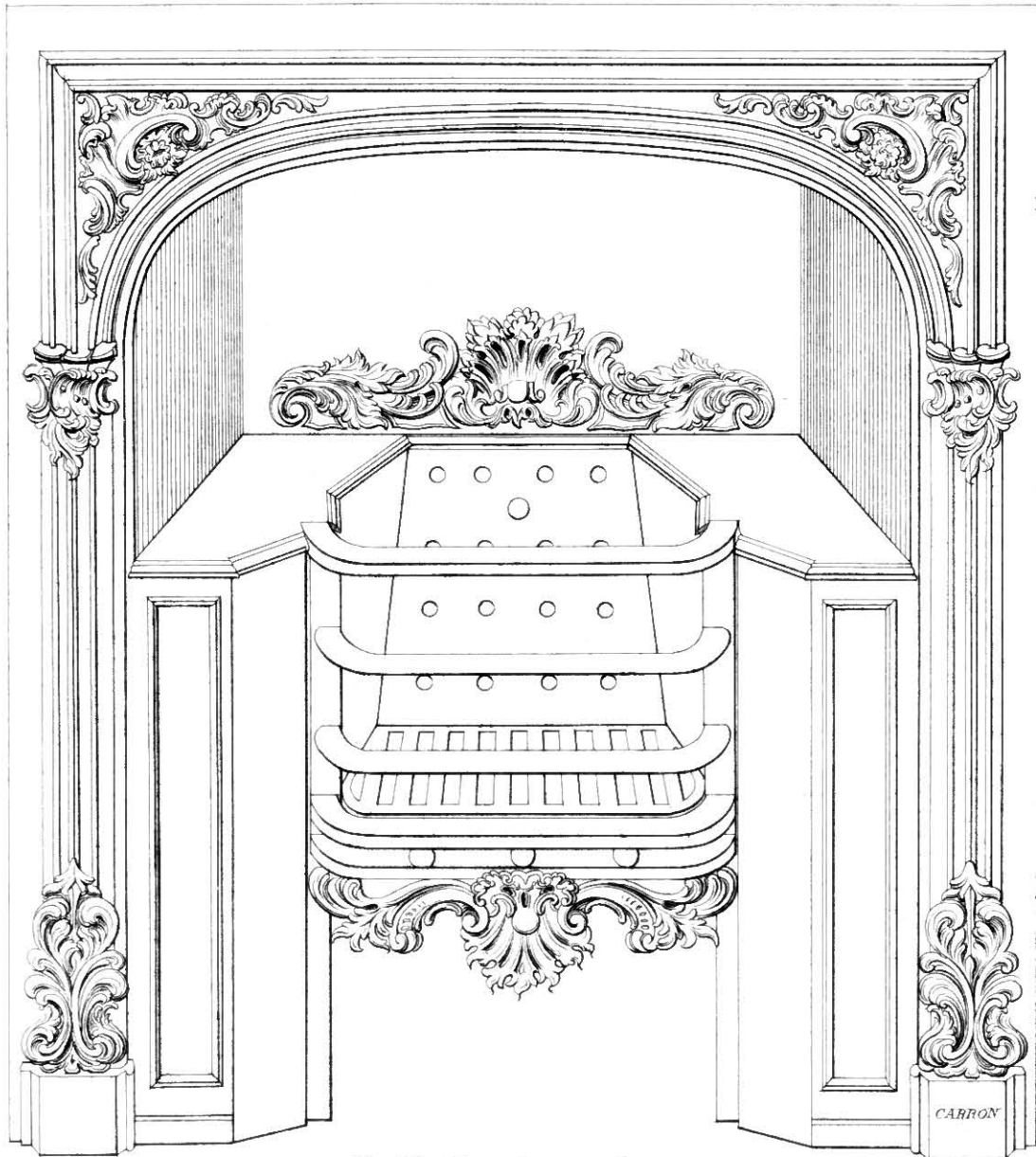

R. E. Register Stove,
With N^o 15+ Front, N^o 10 top Back & N^o 20 Fret.
Sizes 24, 28, 30, 32 x 30 ins. high.

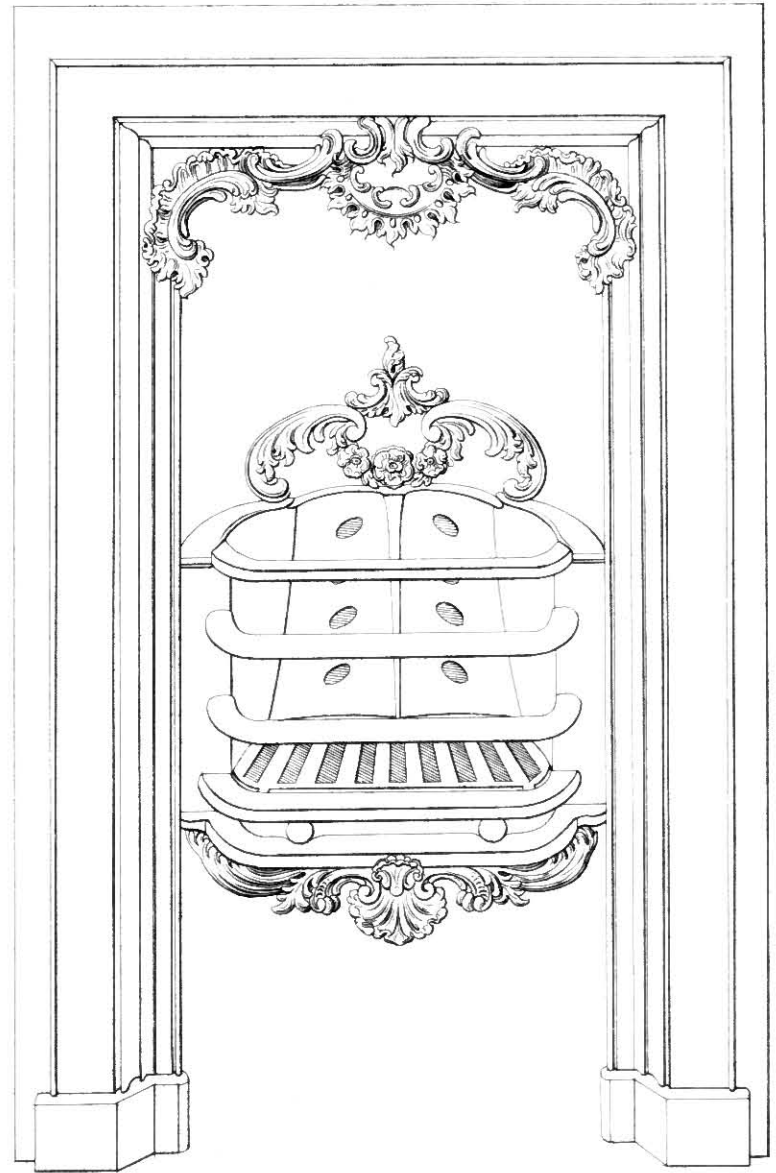

Bed Room Register Stove,
Sizes 16, 18, 20, 22 x 3+ ins. high.

Chimney Piece,

Sizes 24, 26, 28, 30, 32, 34, 36, 38, 40, 42 Inches inside.

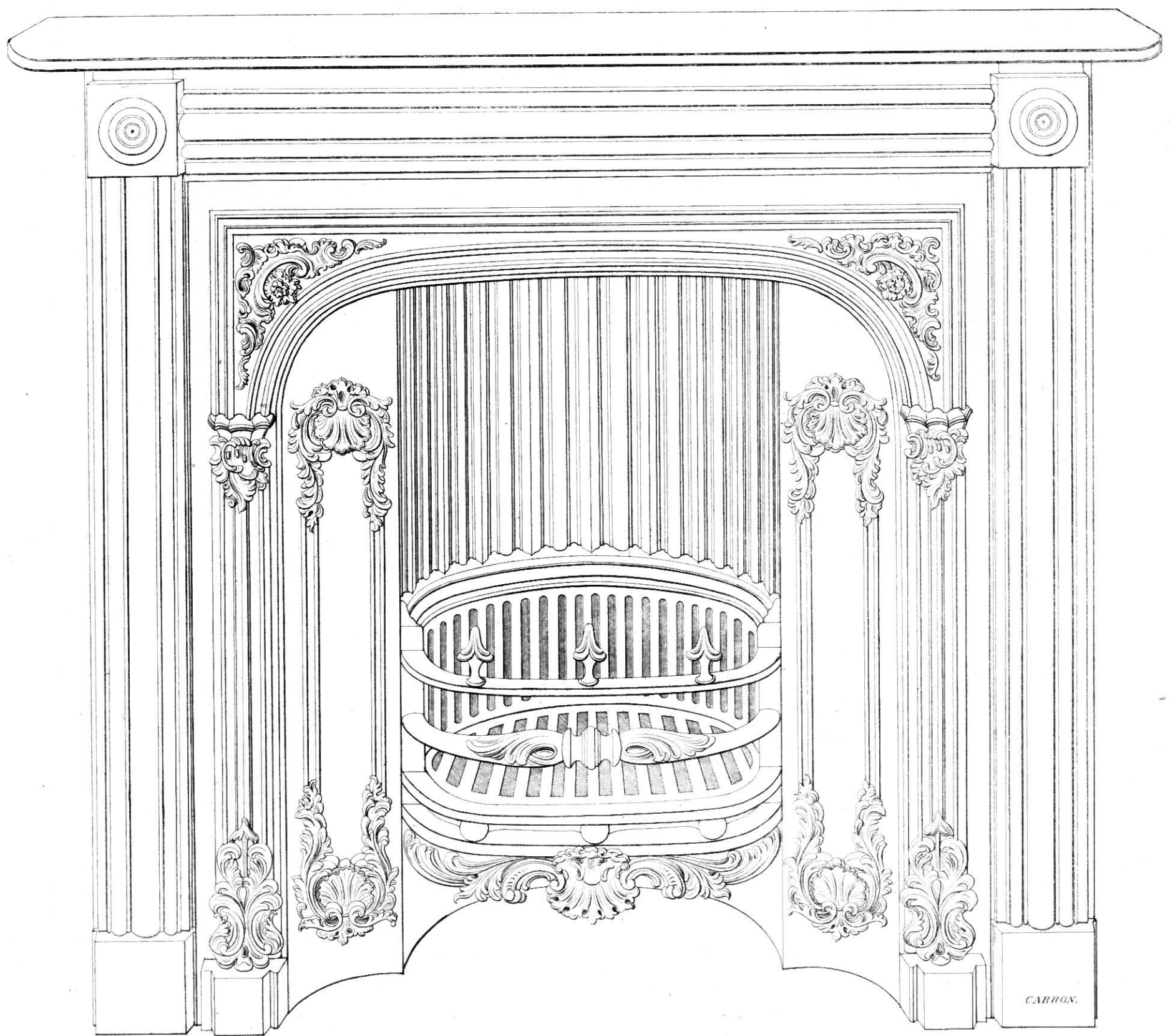

CARRON.

Register Stove,

With N.º 154 Front, N.º 6 Slips, N.º 2 Round Back and O. E. Bars, N.º 20 Fret.

Sizes 32 x 36, to 40 x 42 Inches.

Maclure & Macdonald Lith^{rs}
Glasgow.

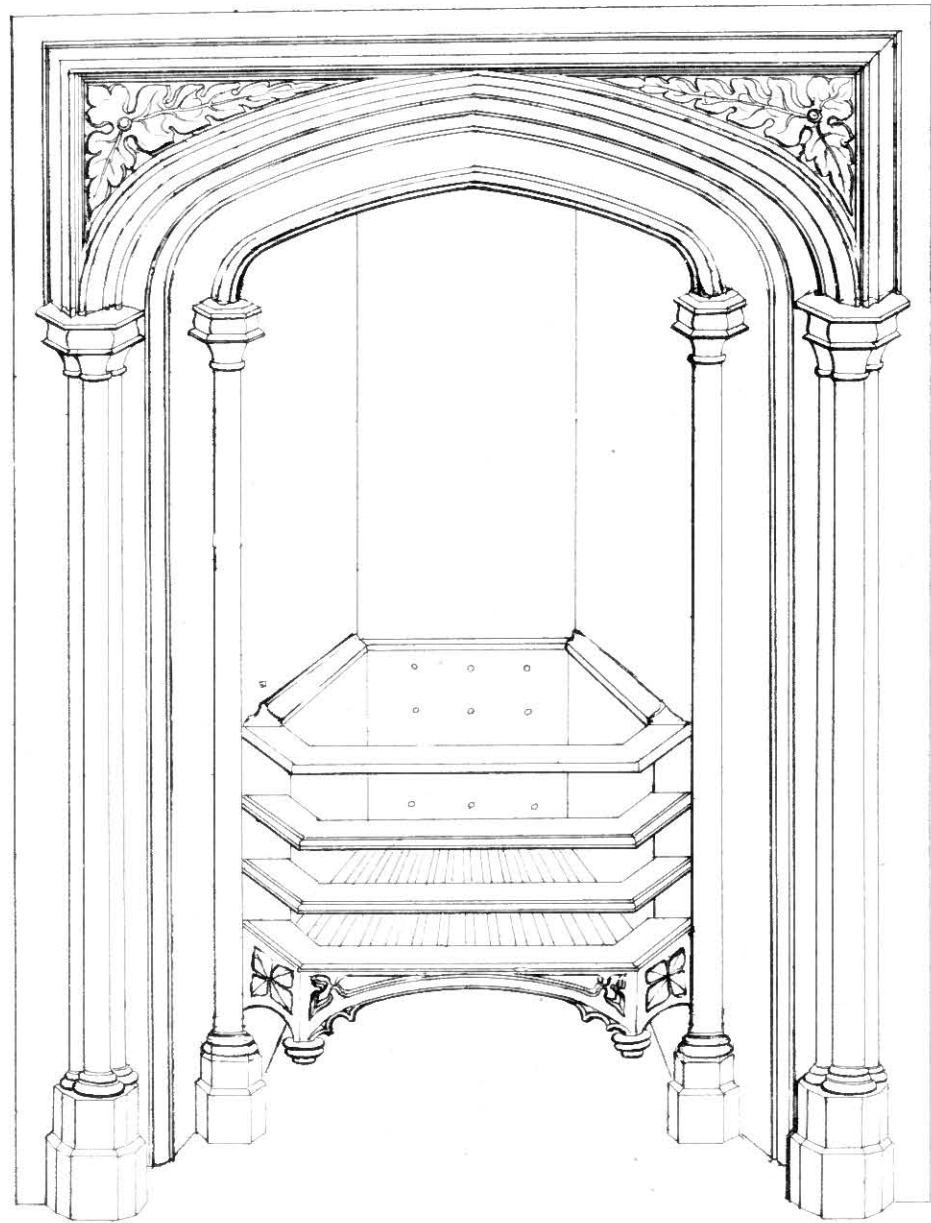

University Gothic Register Stove.

Sizes 20 x 36 - 36 x 36 inches

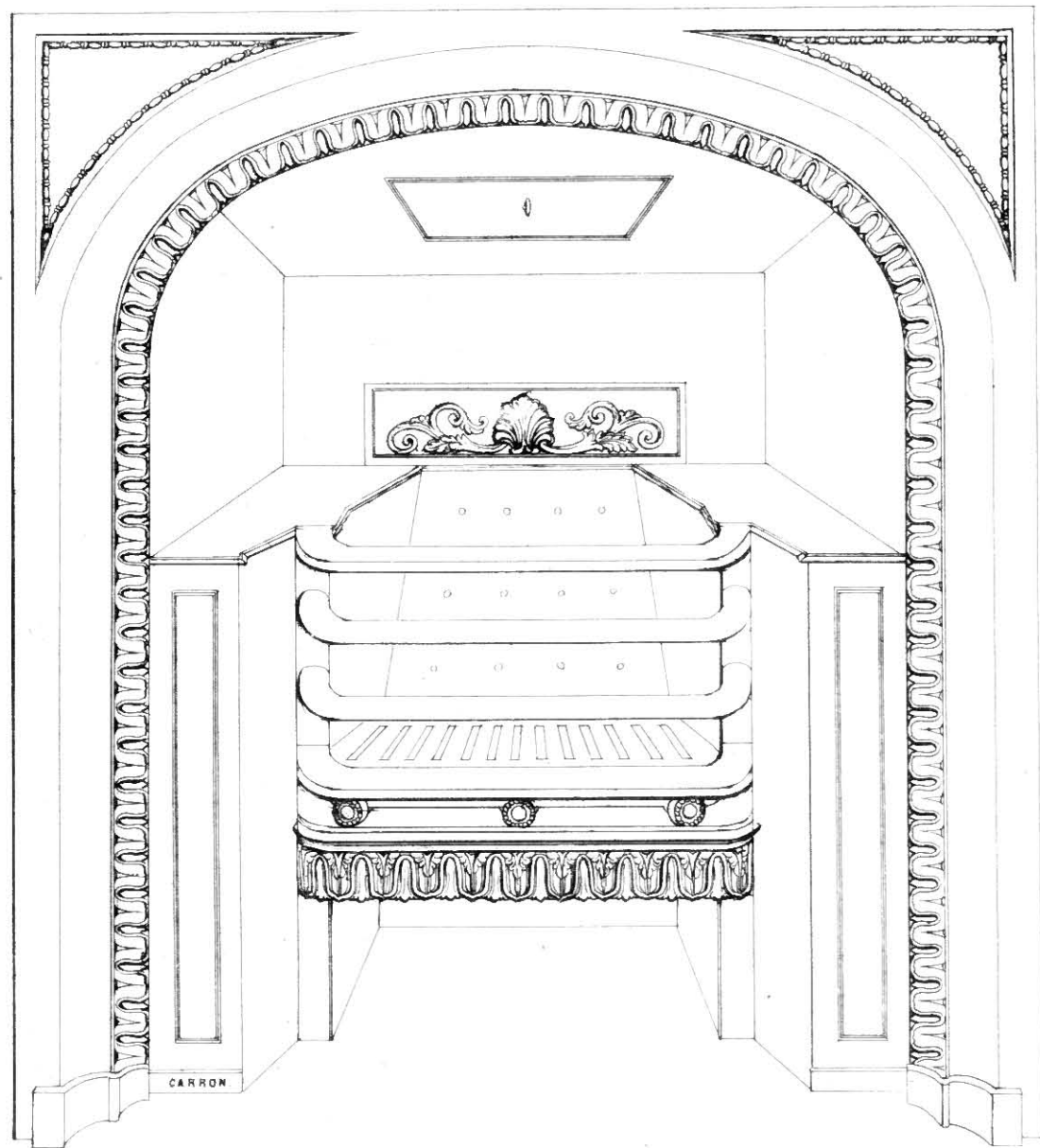

Recess Elliptic Register Stove

with N^o 15 Fret.

Sizes 24 x 36 to 34 x 38 inches

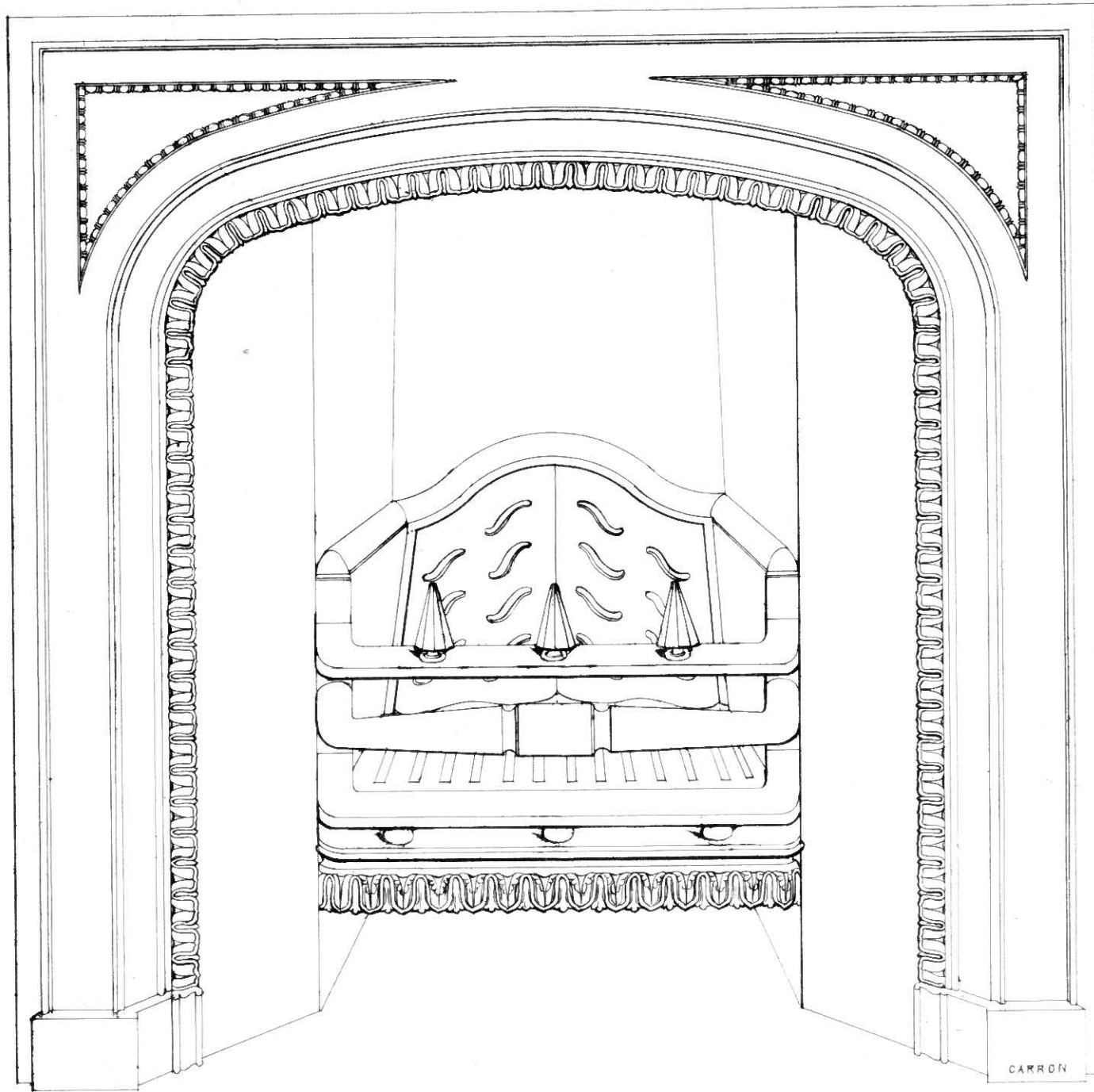

Register Stove,

with N° 49 Front, Ground Checks, N° 3 inside Back and C Bars,

with N° 15 Fret.

Sizes 28 x 32 to 42 x 44 Inches.

Maclure & Macdonald, lith.
57 Buchanan St.

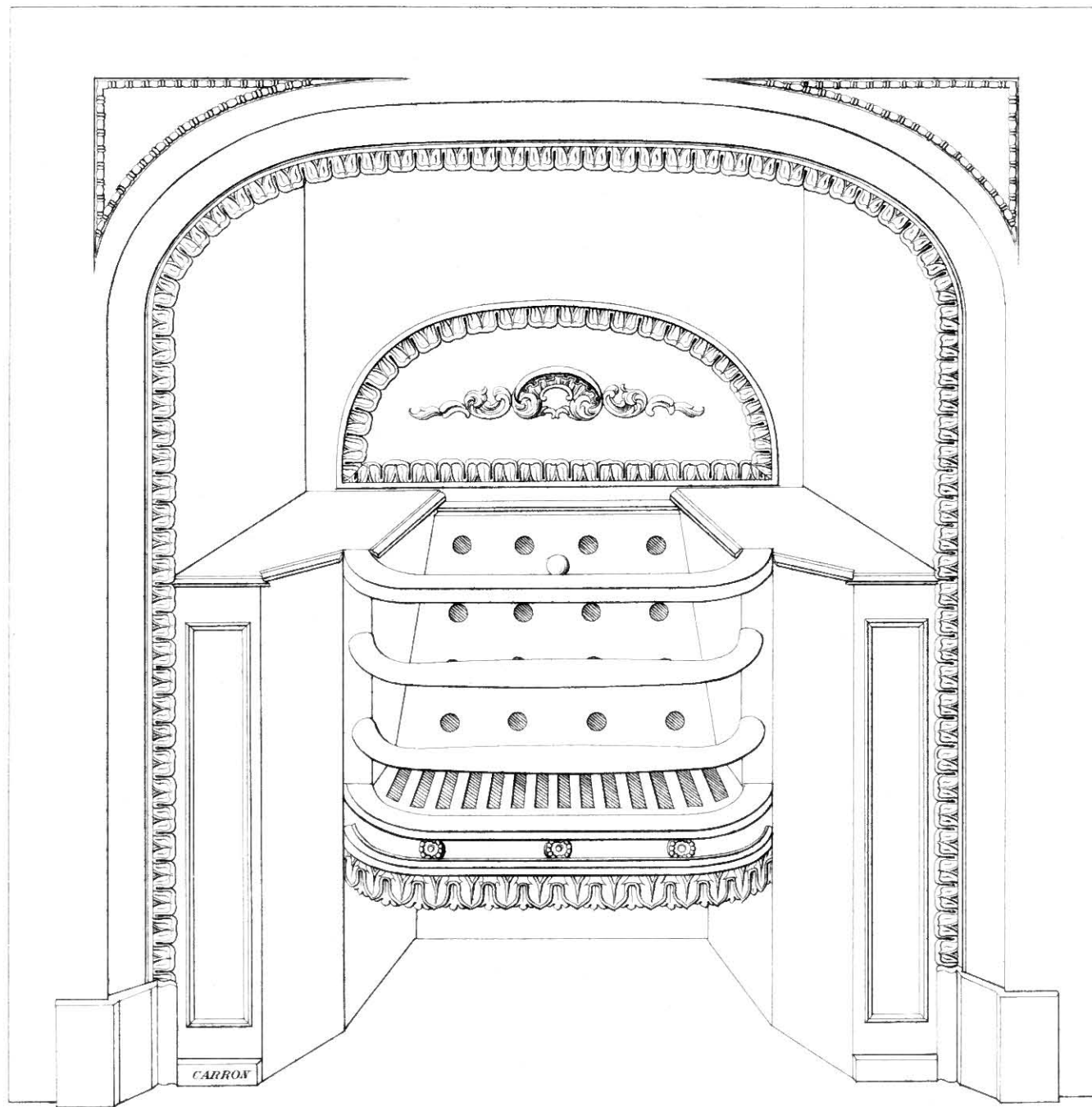

Recess Register Stove

With N° 149 Front, N° 6 top Back & plain Bars with N° 15 Fret.

Sizes 32 - 36 to 40 - 40 inches

MaClure & Macdonald Lith^{rs}
Glasgow.

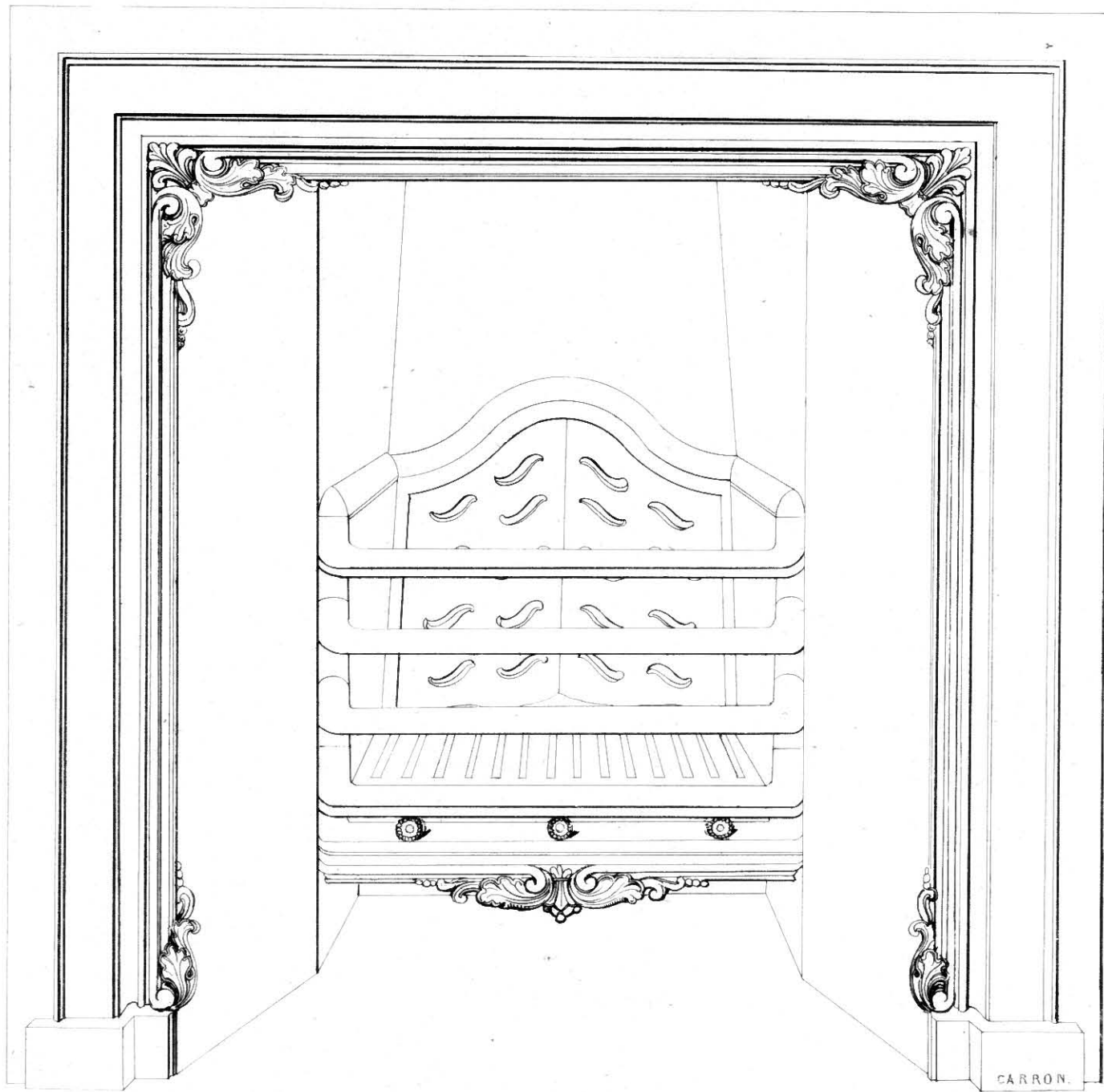

Register Stove,

with N° 151 Front, Ground Cheeks, N° 3 inside Back & plain L. Bars

with N° 16 Fret.

Sizes 34 x 36 to 42 x 42 inches

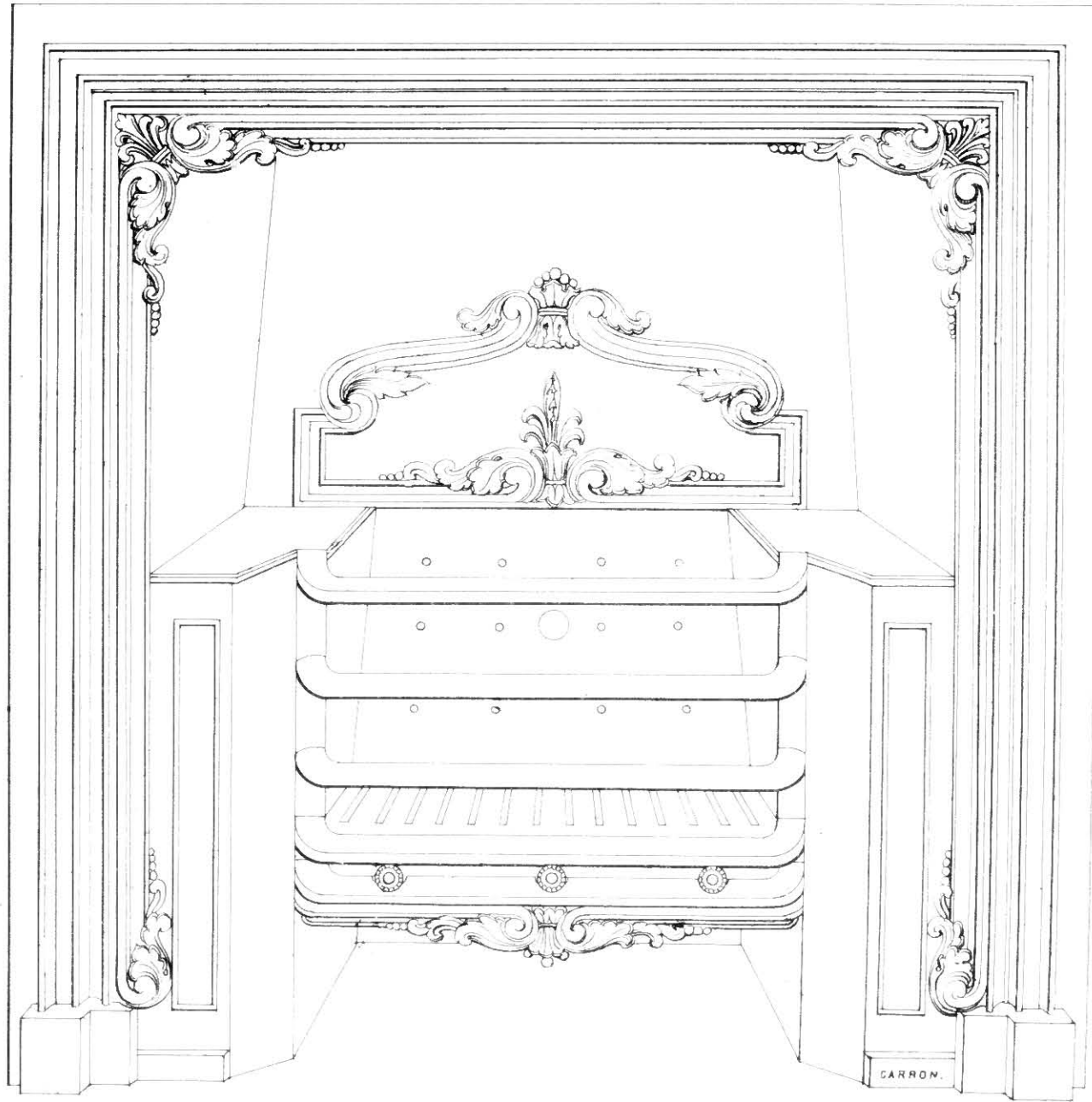

Recess Register Stove

with N° 151 Front N° 7 Top Back & 1. Bars, with N° 16 Feet.

Sizes 33 x 36 to 40 x 42 inches.

*MacLure & Macdonald Lith^{rs}
27 Buchanan St.*

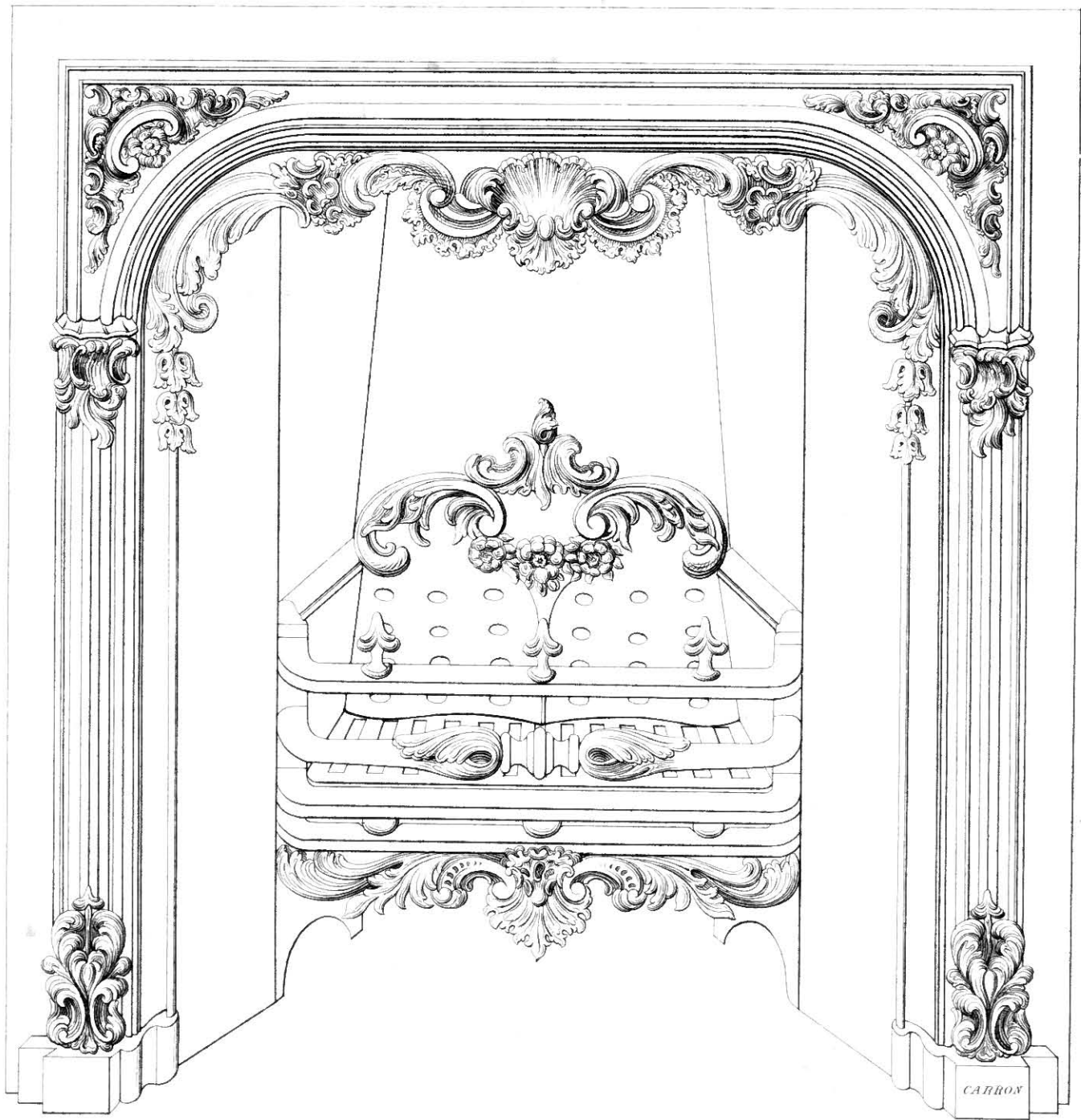

*Register Stove,
With inside Ornament.*

With N^o 154 Front, ground Cheeks, N^o 5 inside Back, & F Bars with N^o 20 Fret.

Sizes 33 x 36 to 40 x 42 inches.

Maclure & Macdonald Lith^{rs}
Glasgow

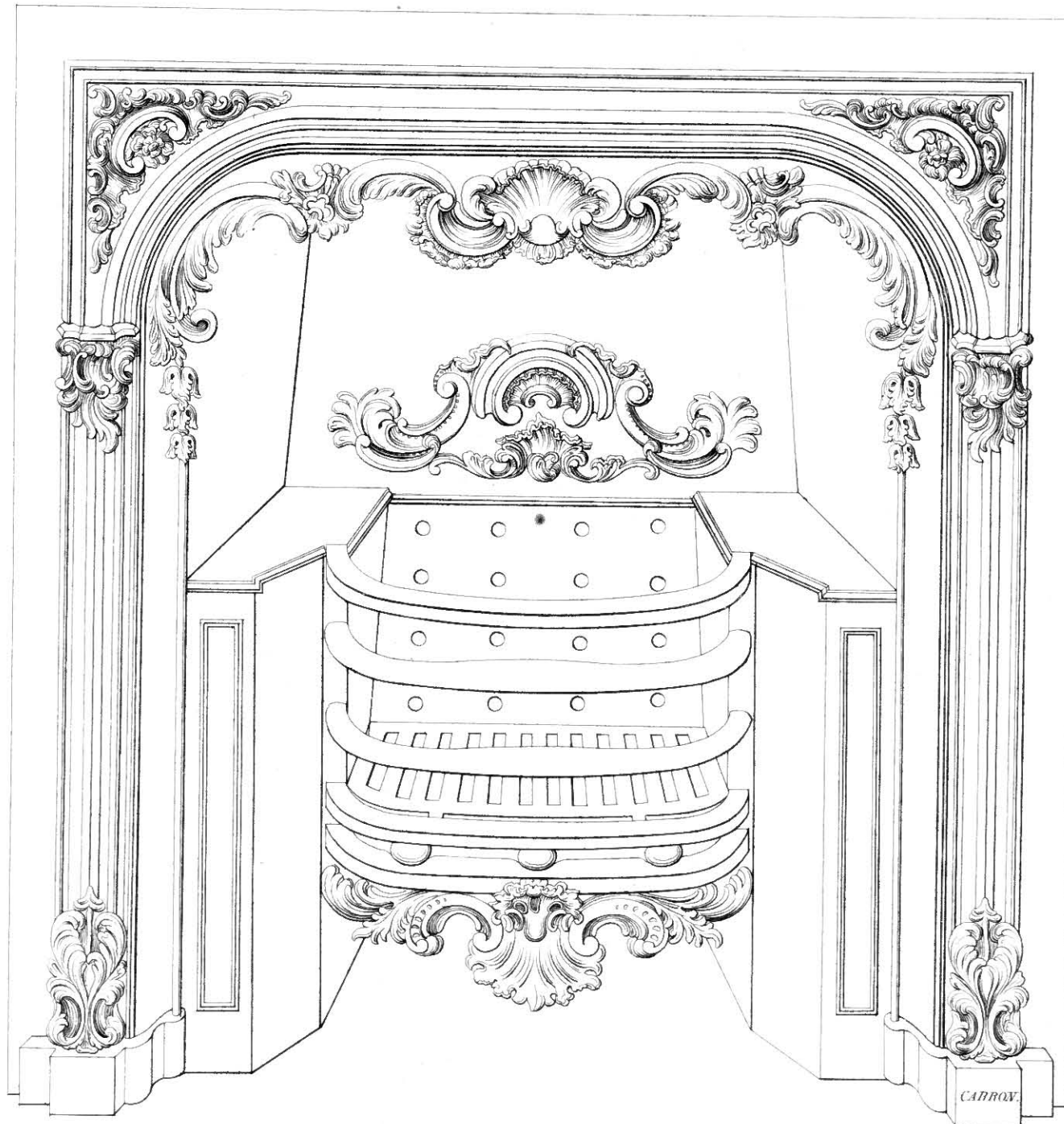

*Recess Register Stove,
With N° 154 Front, with inside Ornament
N° 8 top Back & plain elliptic Bars with N° 20 Fret.
Sizes 33 x 36 to 40 x 42 inches.*

Maclure & Macdonald Lithrs
Glasgow.

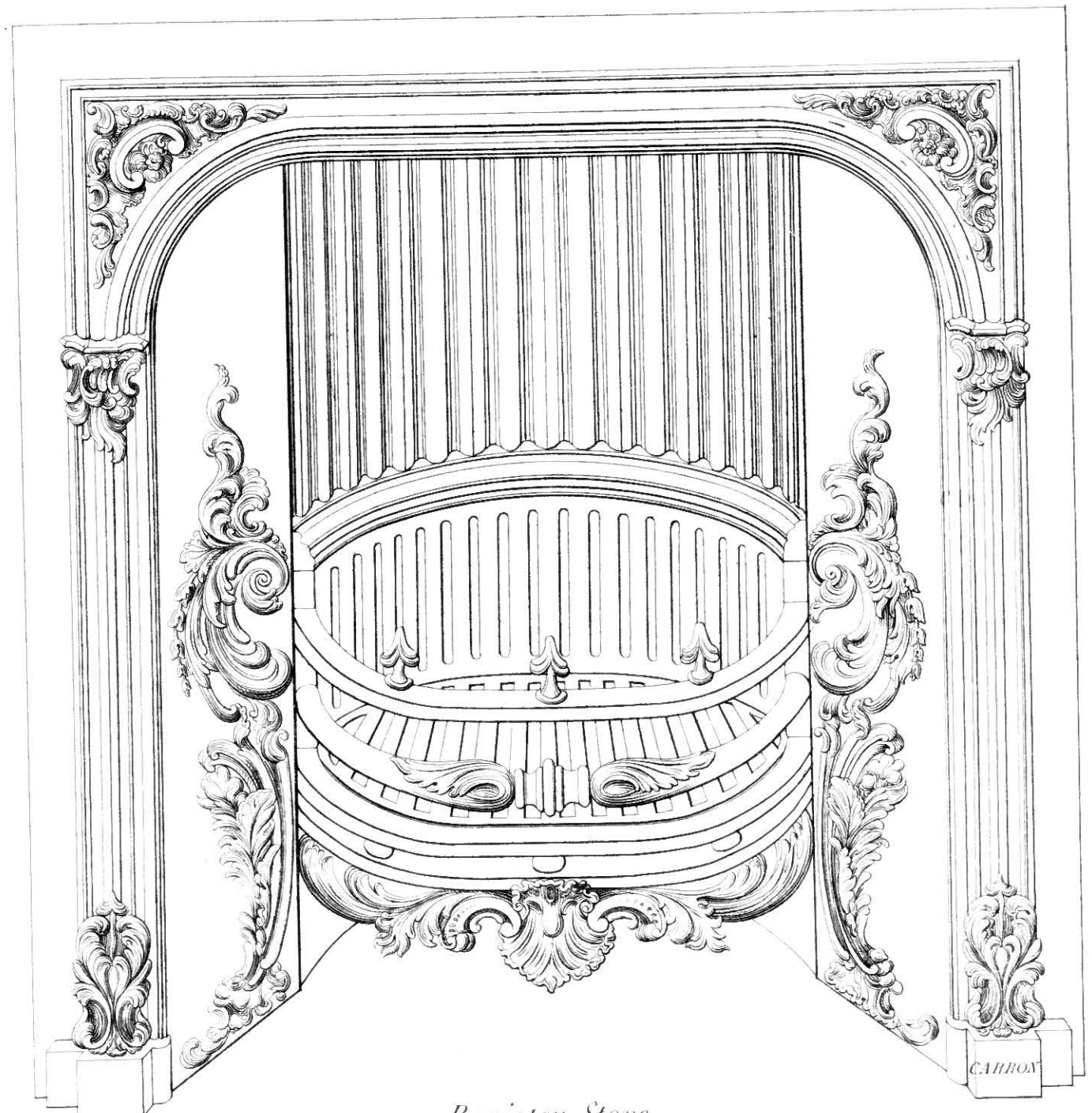

*Register Stove,
With N^o 15* Front without inside Ornament,
N^o 3 Slips, N^o 2 Round Back, & O. E. Bars, with N^o 20 Fret.*

Sizes 32 x 36 to 40 x 42 inches.

*Maclure & Macdonald Lith^{rs}
Glasgow.*

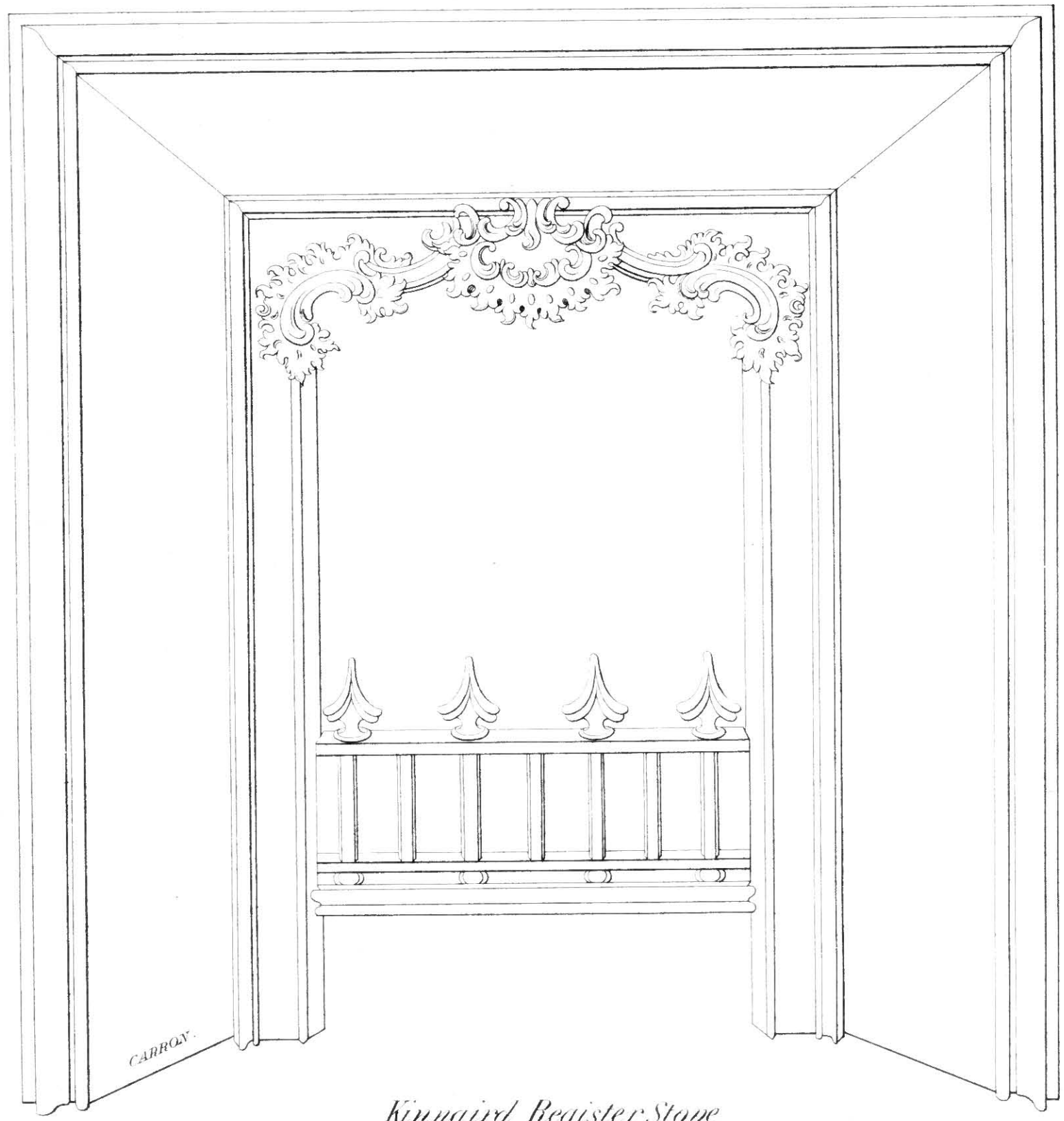

CARRON.

Kinnaird Register Stove

With either cast iron or fire Brick Back.

Sizes 32 - 34 to 44 - 46 Inches



Register Stove.

With N° 157 front, ground slips, N° 3 round back, & H. Bars with N° 22 fret.

Sizes 33 x 35 ins. to 42 x 42 ins.

Maclure & Macdonald, Lith.

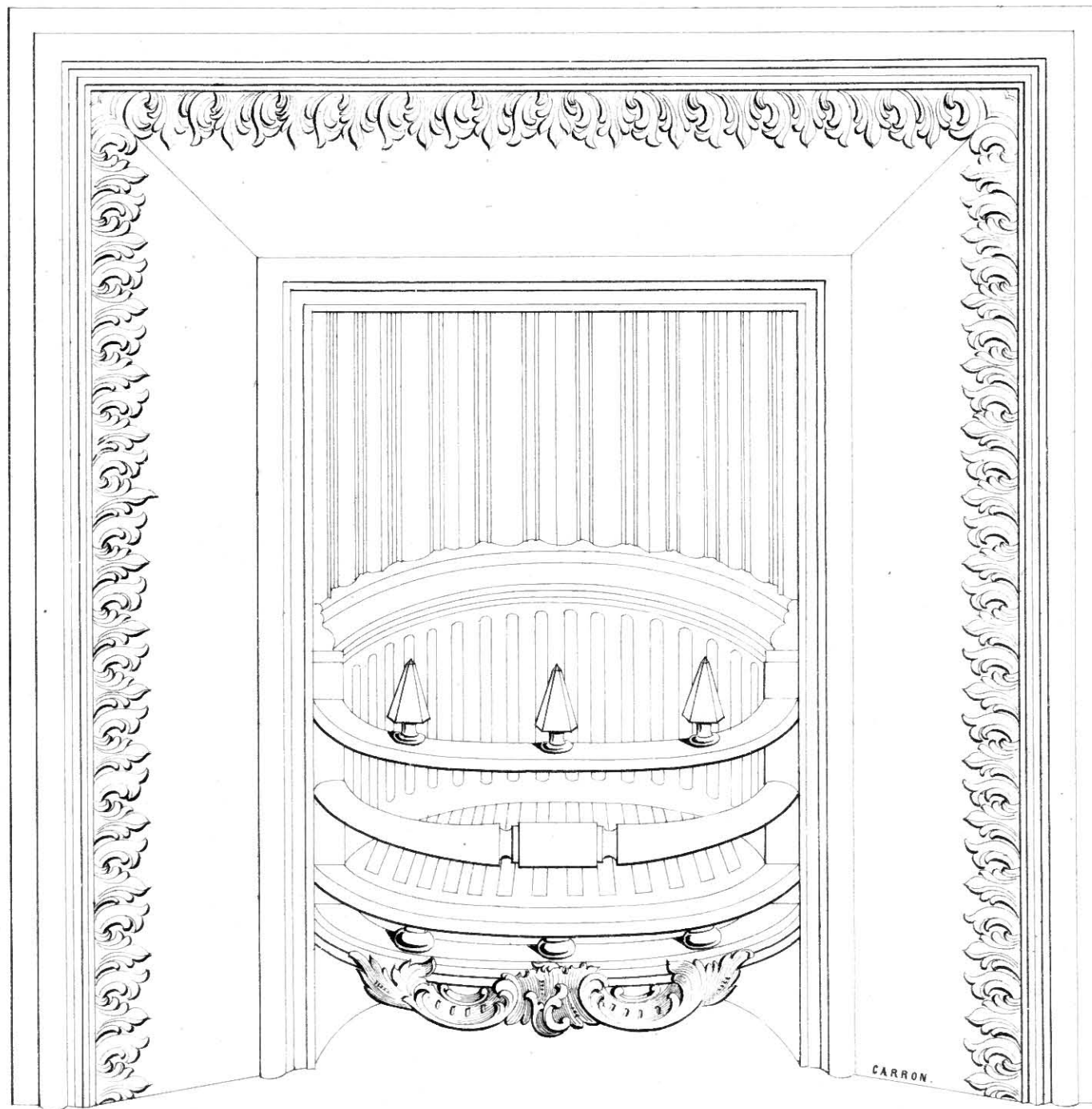

Kinnaird Stove.

With ground slips N^o 2 Mouldings, N^o 2 Round Buck & B. Bars, with N^o 22 fire.

This Stove can also be made with straight Bars & Fire Bricks as on plate 34.

SIZES 29 x 34 to 44 x 44 In.

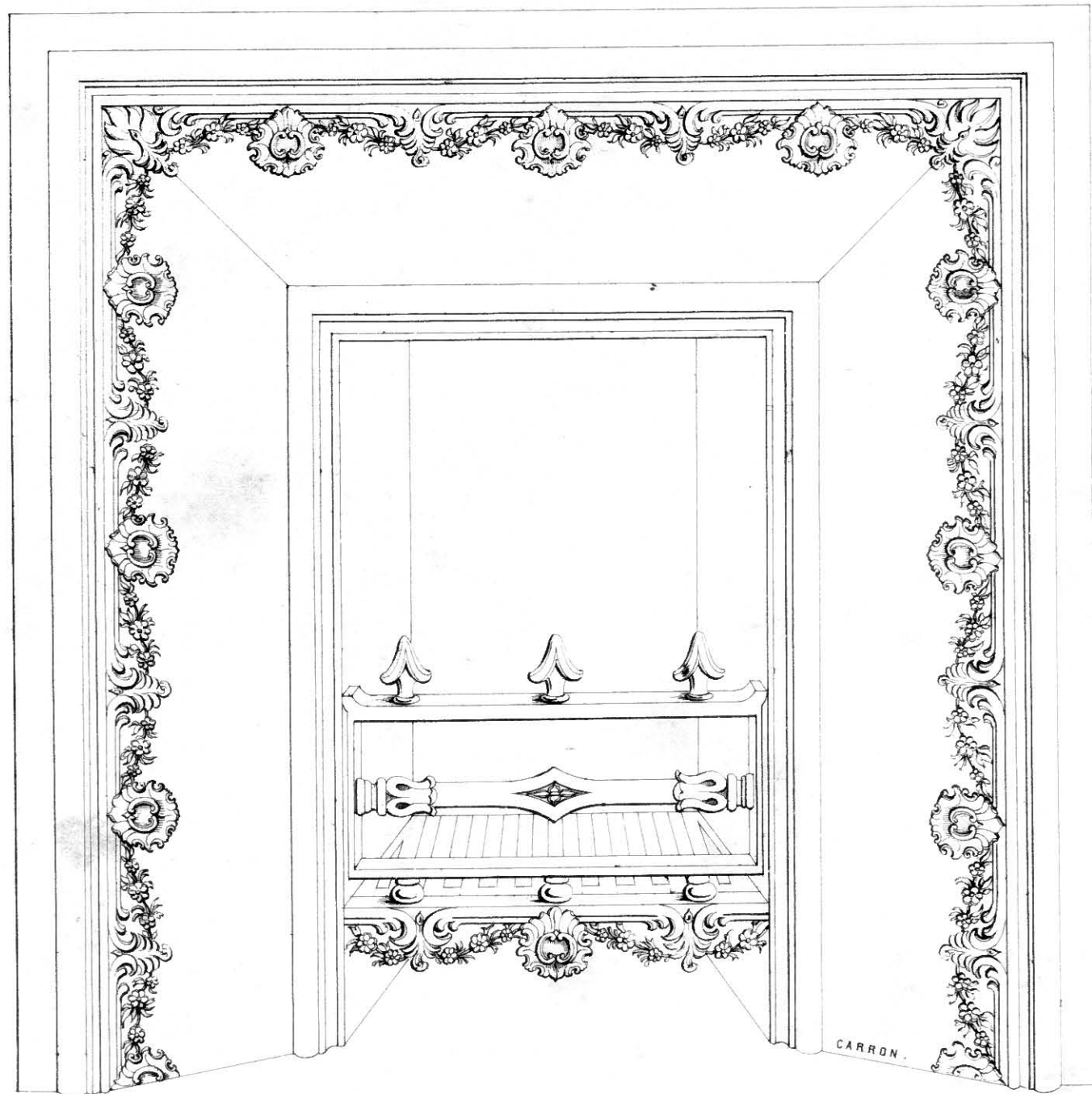

Kinnaird Stove.

With ground Slips, N^o. 3 Mouldings, & N^o. 3 Ornamental Bars with fire.

This Stove can be made either with Fire Bricks & Straight Bars as above, or with N^o. 2 or 3 Round Back & Elliptic Bars, as on Plates 32 & 33.

Sizes 29 x 34 to 44 x 44 in.^s

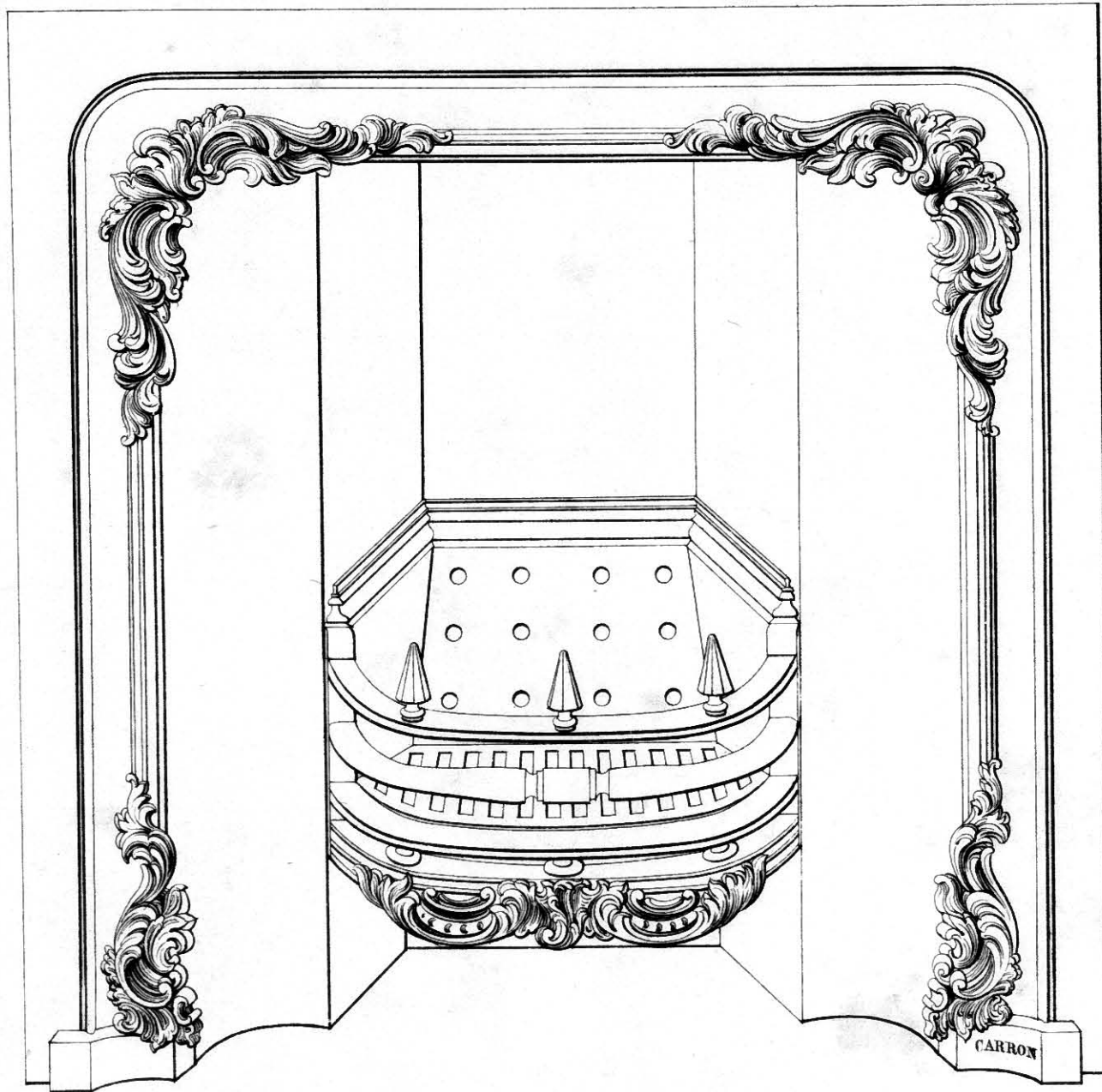

Register Stove,

*With N^o. 158 front, N^o. 7 Slips, N^o. 150 Back & B. Bars with N^o. 22 fret.
Sizes 24 x 34 to 42 x 44 Inches.*

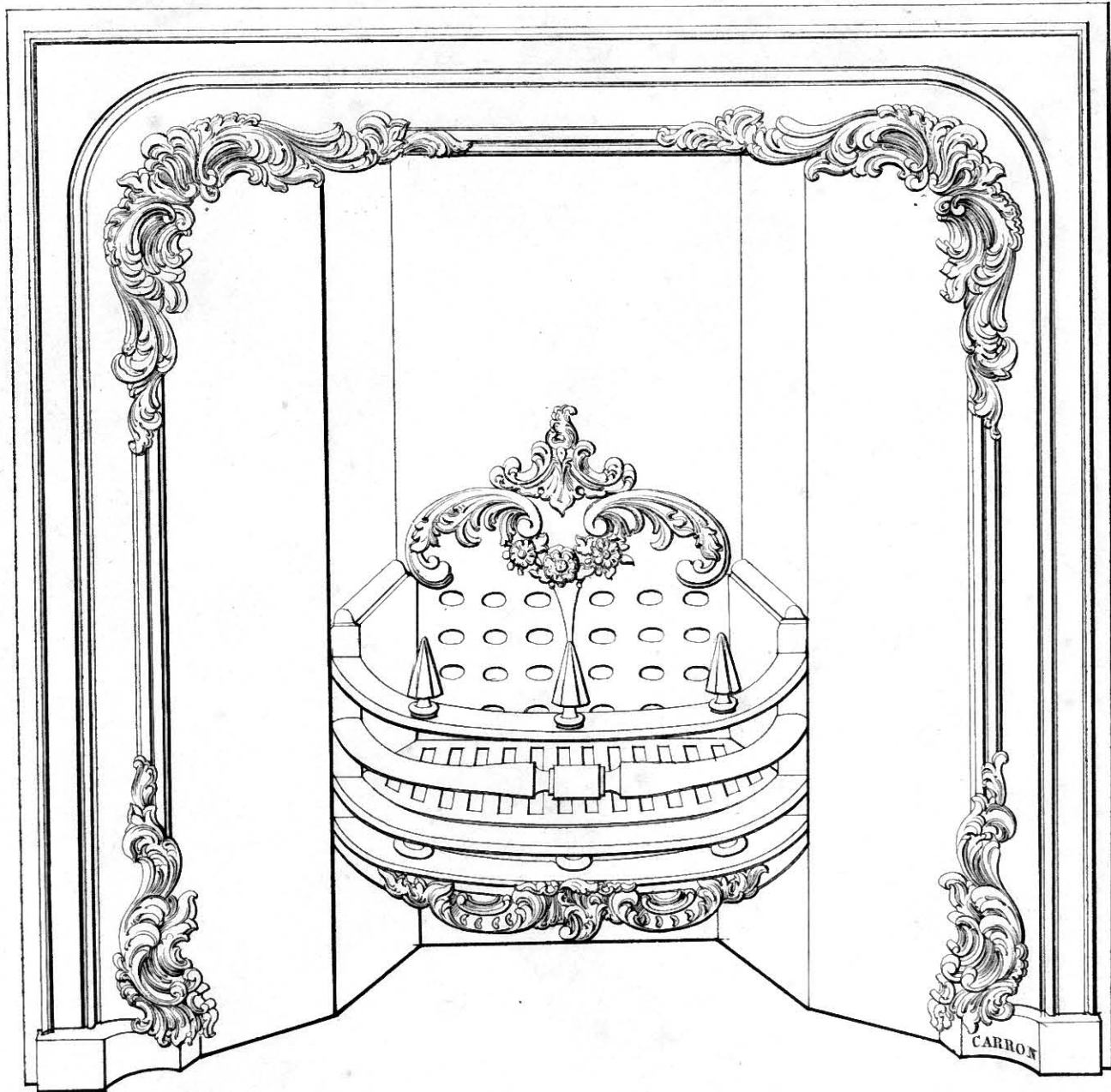

Register Stove,

With N^o 158 front, Ground Cheeks, N^o 5 Inside Back, & B. Bars, with N^o 22 Fret.

Sizes 32 x 34 to 42 x 44 Inches.

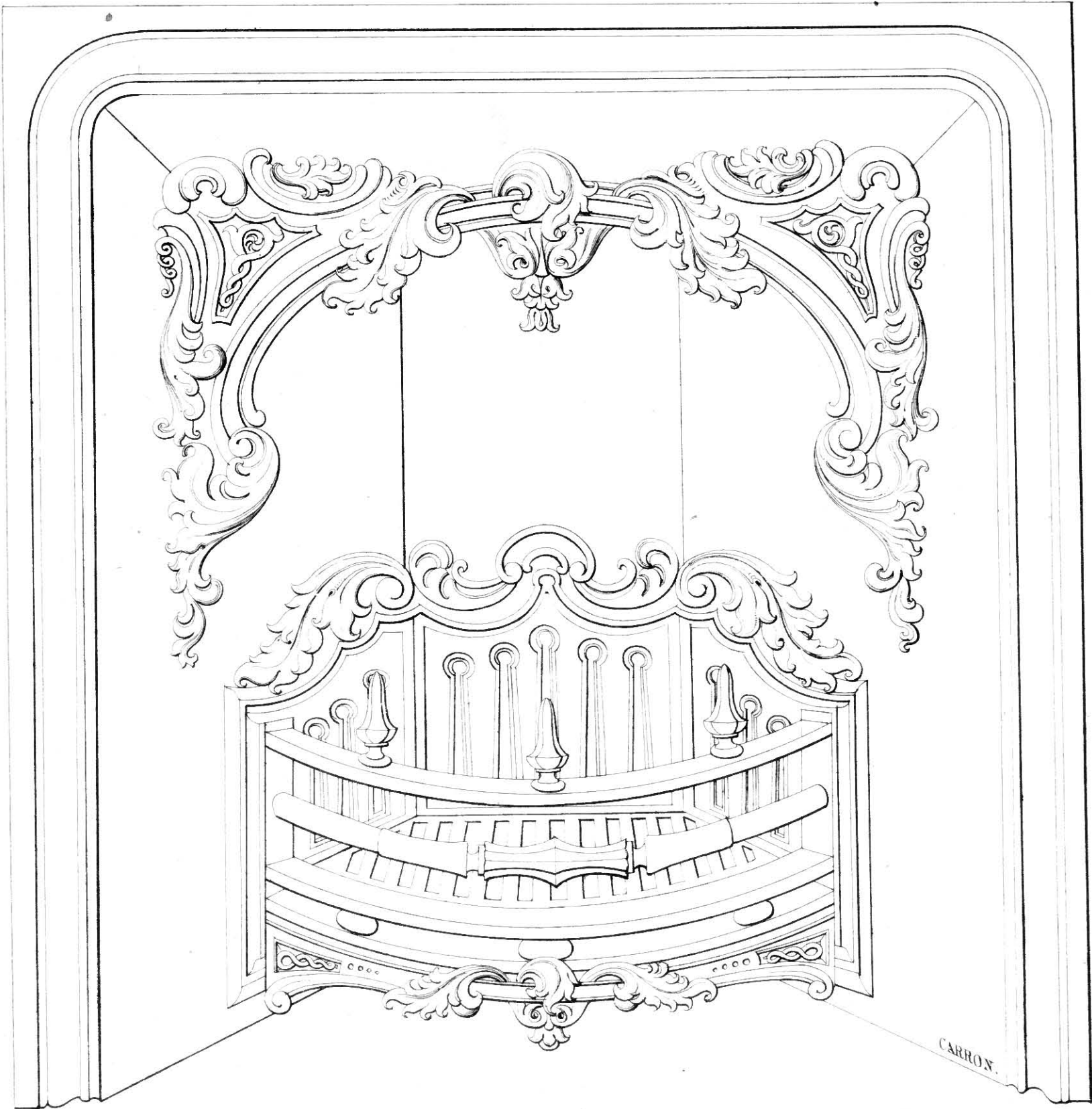

Register Stove,

*With N° 161 Front ground ground straight Checks, with Lintel & Filed
M. Bars, inside Checks & Back.*

It can be made also with ornamented Bars with Spikes.

Sizes 33 35 to 44 - 44 inch.

*Fender N^o 15
with or without Stands*

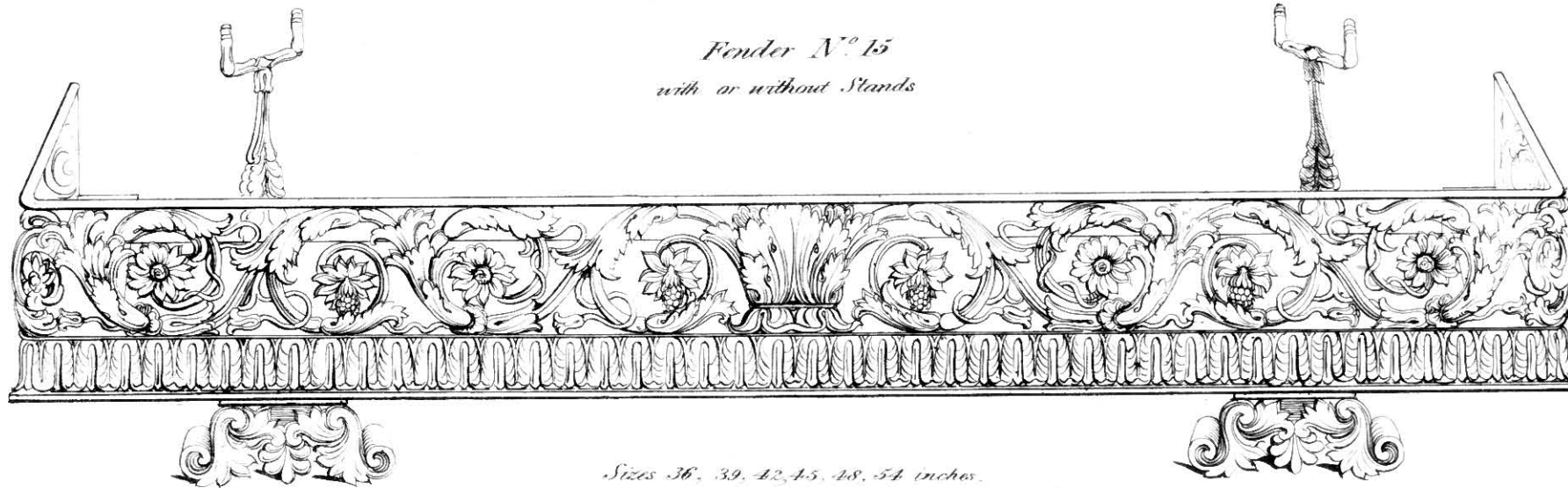

Sizes 36, 39, 42, 45, 48, 54 inches.

Fender N^o 16

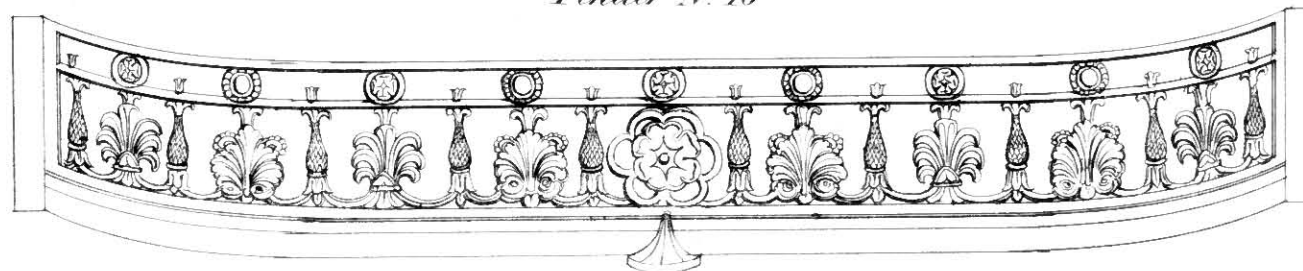

Sizes 27, 30, 33, 36, 39, 42, 45, 48 inches

*Fender N^o 17
with or without Stands*

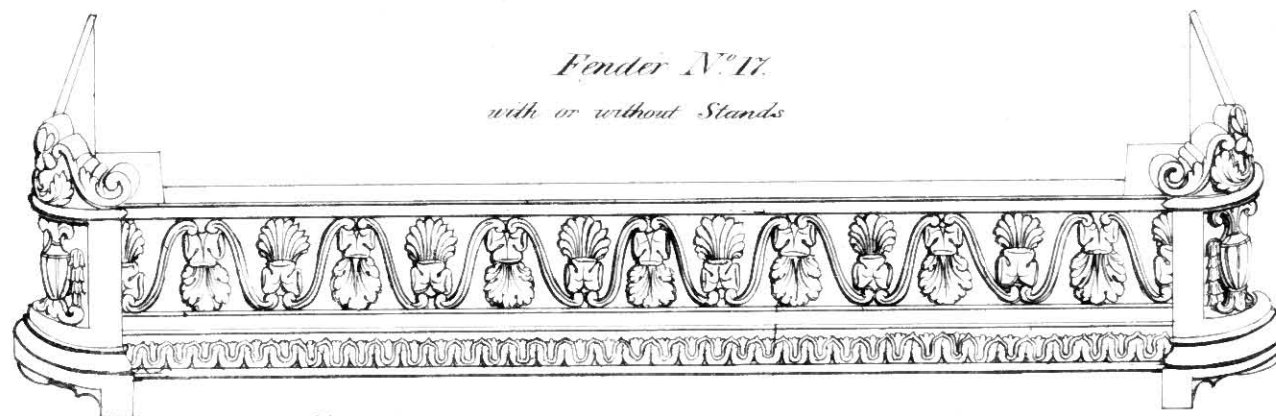

Sizes 27, 30, 33, 36, 39, 42, 45, 48, 51, 54 inches

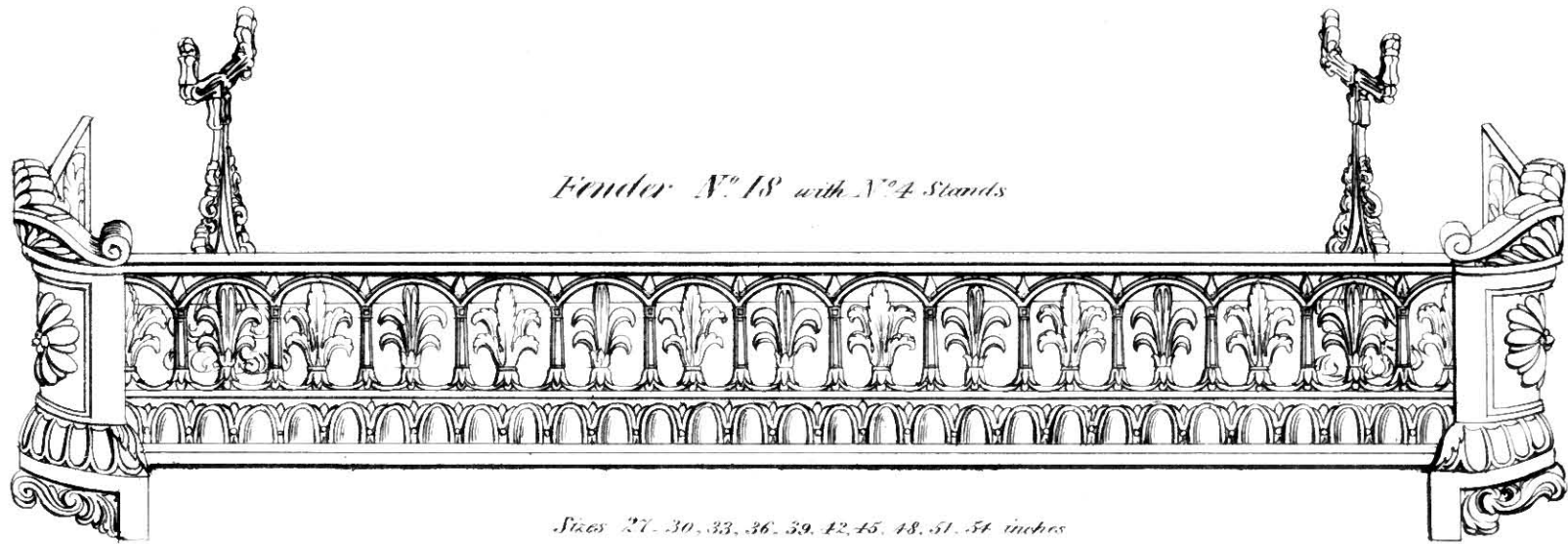

Fender N° 18 with N° 4 Stands

*Sizes 27, 30, 33, 36, 39, 42, 45, 48, 51, 54 inches
with or without Stands.*

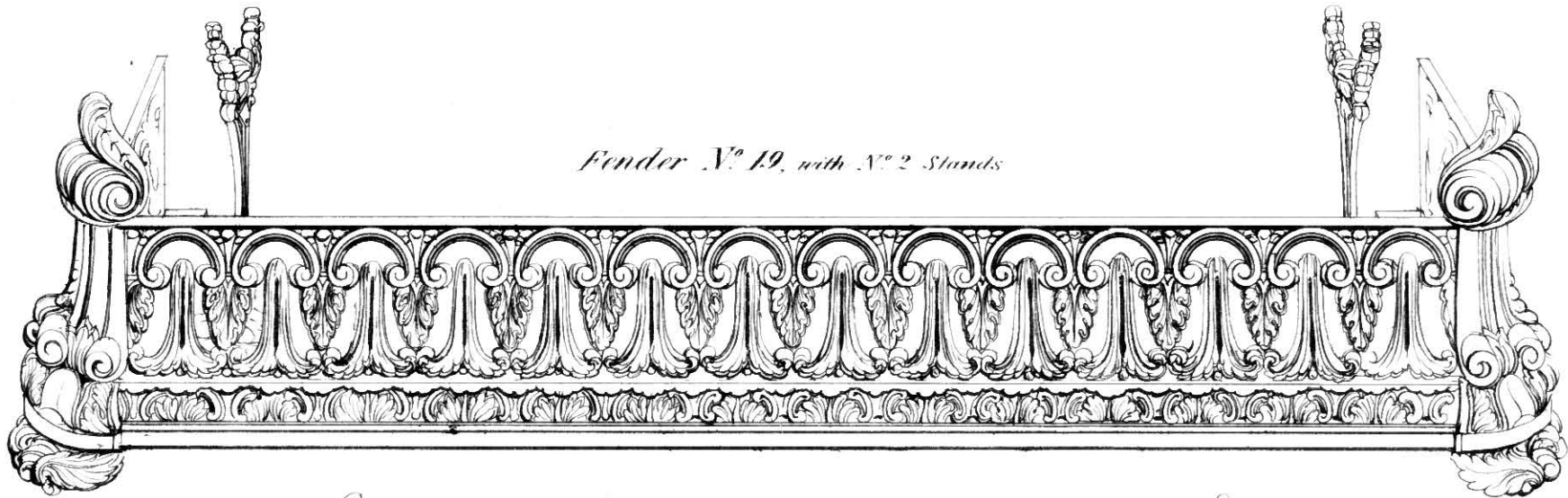

Fender N° 19, with N° 2 Stands

*Sizes 36, 39, 42, 45, 48, 51, 54, 57, 60 inches
with or without Stands*

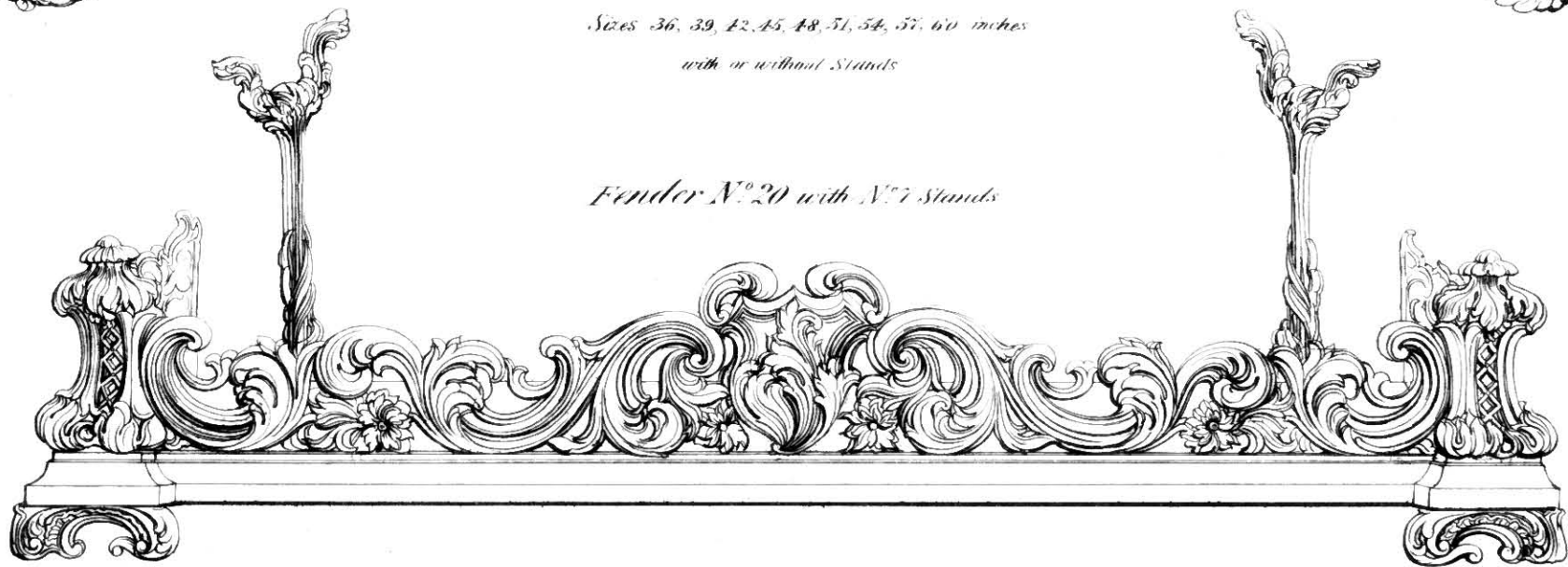

Fender N° 20 with N° 7 Stands

Sizes 27, 30, 33, 36, 39, 42, 45, 48, 51, 54 inches

Close Kitchen Fender N^o 23.



Sizes 27 to 60 inches.

*Fender N^o 21,
with or without Stands.*

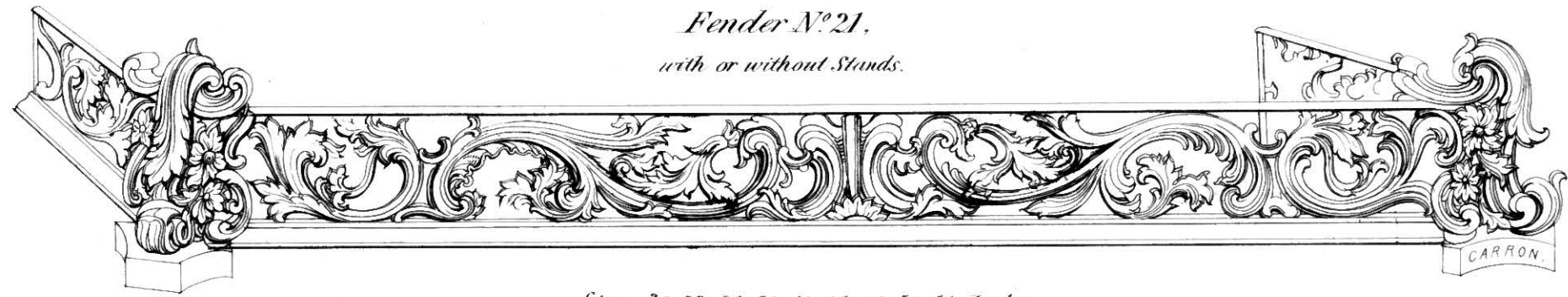

Sizes 30, 33, 36, 39, 42, 45, 48, 51, 54 Inches.

*Fender N^o 22 with N^o 7 Stands
with or without Stands*

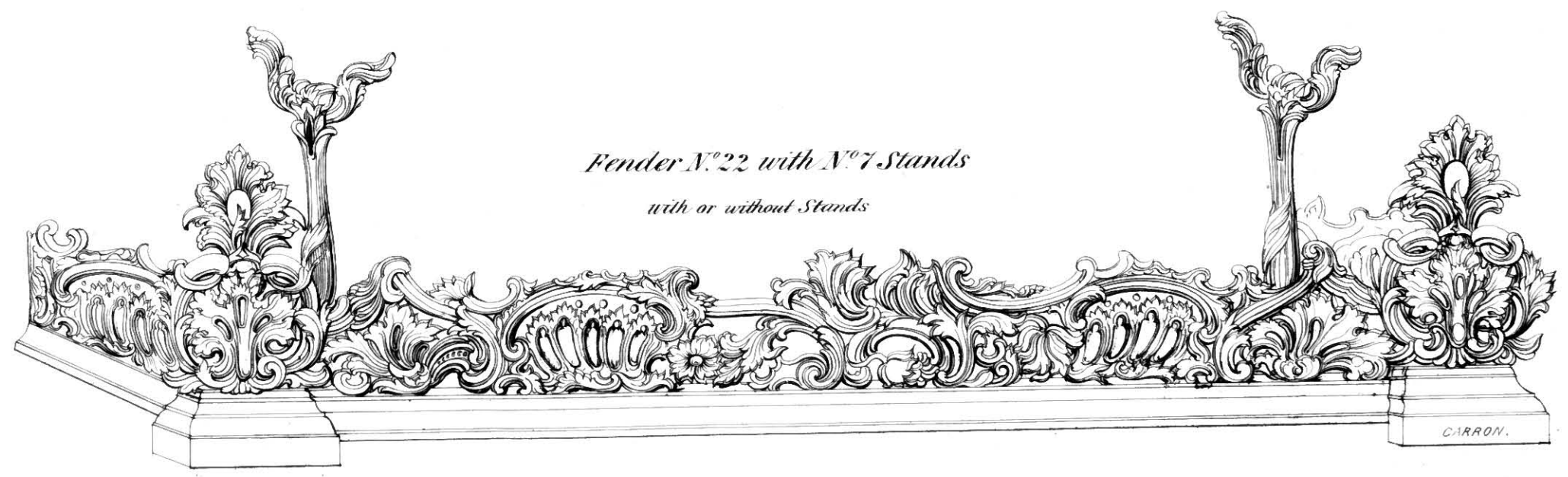

Sizes 36, 39, 42, 45, 48, 51, 54 Inches.

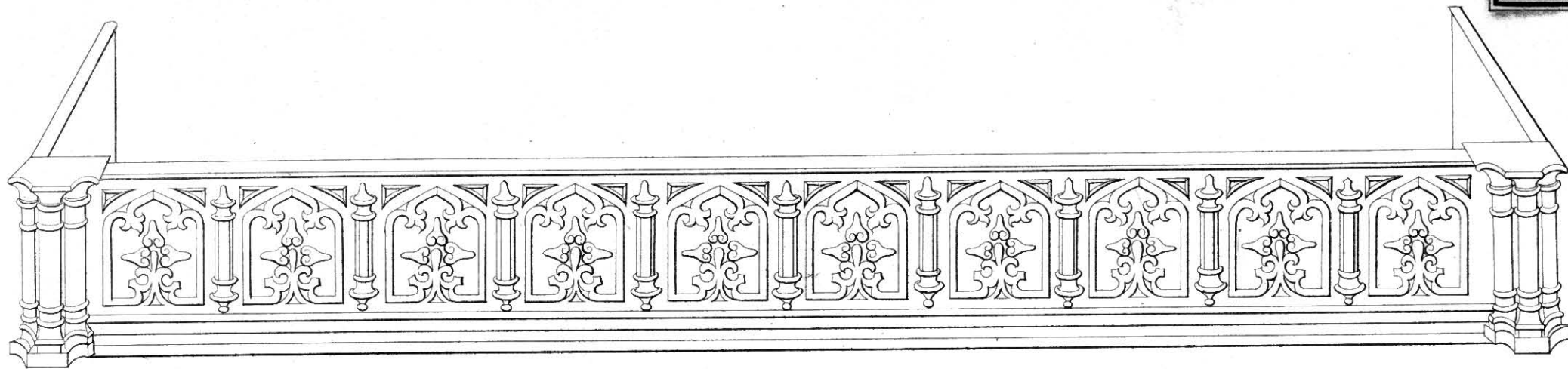

Office Fender N^o 24 with solid Front.

*Sizes 27, 30, 33, 36, 39, 42, 45, 48, 51,
54, 57, 60 inches.*

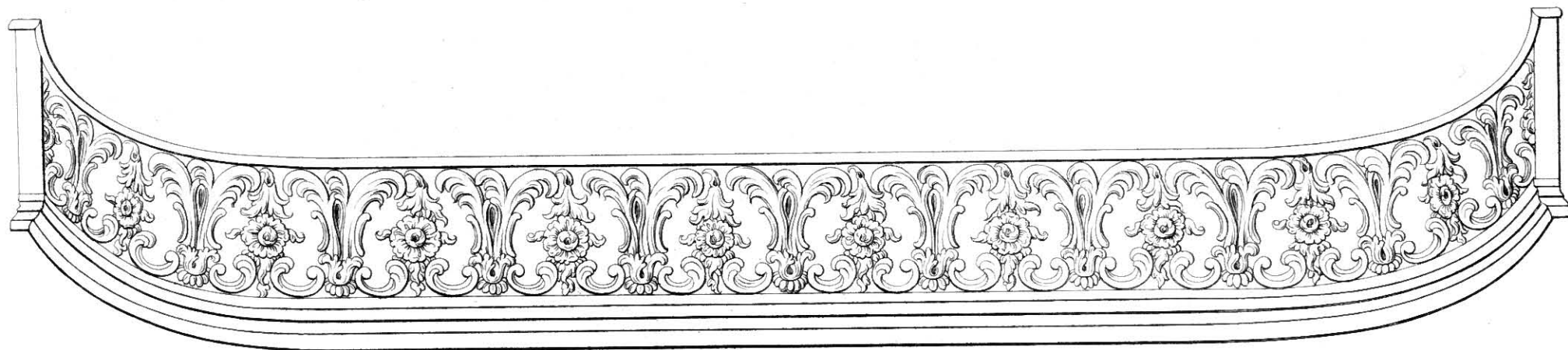

Open Elliptic Fender N^o 25. with or without wrought Iron bottom,

Sizes 27, 30, 33, 36, 39, 42, 45, 48 inches.

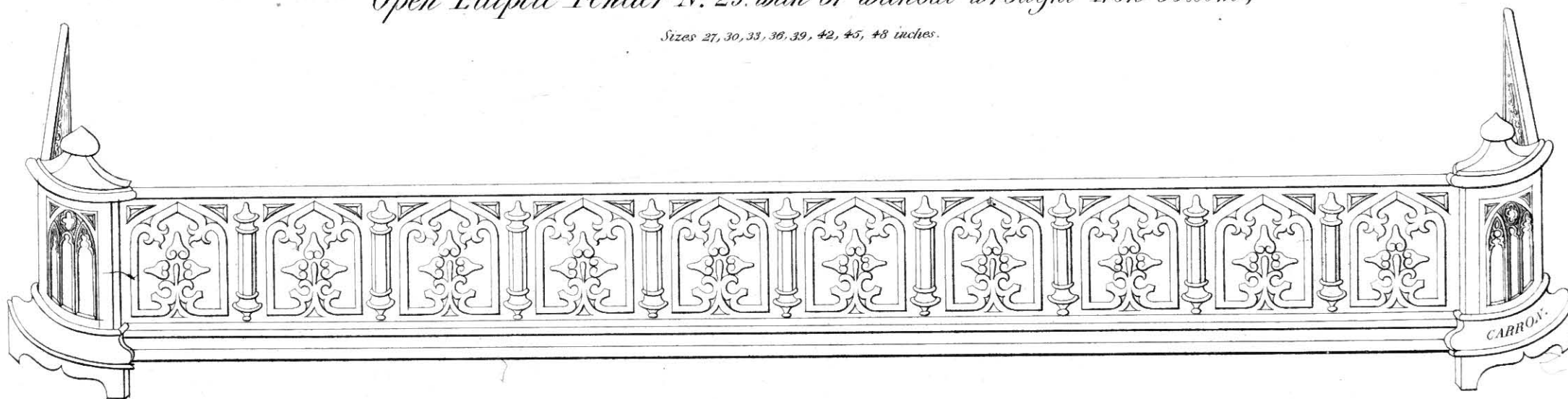

Open Fender N^o 26.

*Sizes 27, 30, 33, 36, 39, 42, 45, 48, 51, 54, 57, 60 inches.
with or without Stands*

This Design is Registered by Carron Company.

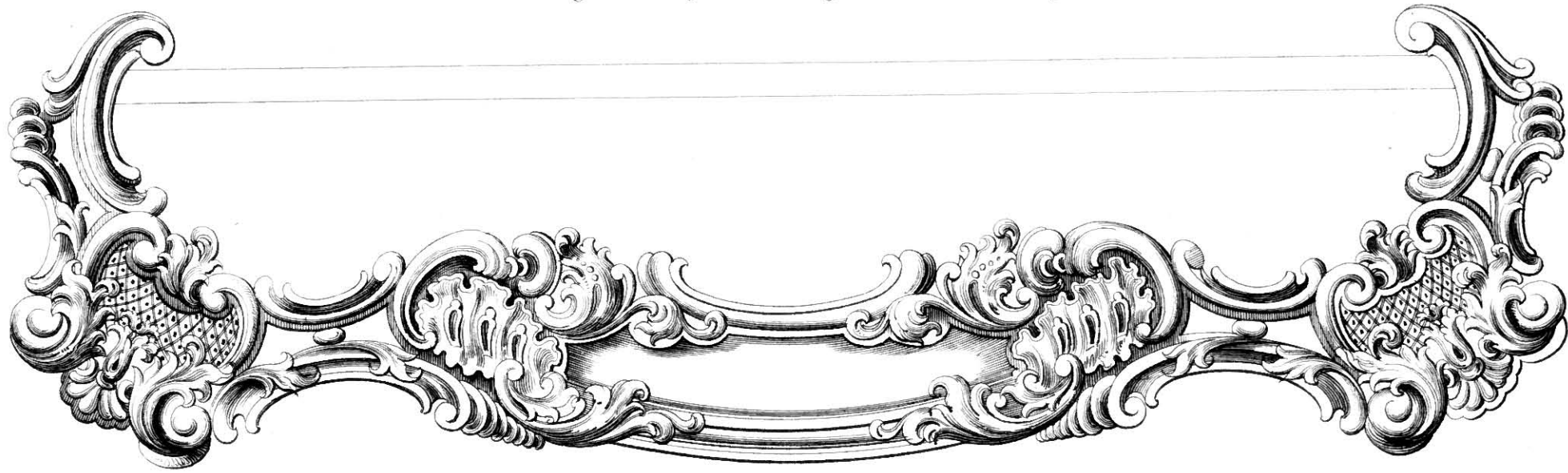

*Fender N^o. 32 without Centre Ornament
Sizes 36, 39, 42 Inches, with or without Standards.*



*Fender N^o. 32 with Centre Ornament
Sizes 45, 48, 51, 54, 60 Inches with or without Standards.*

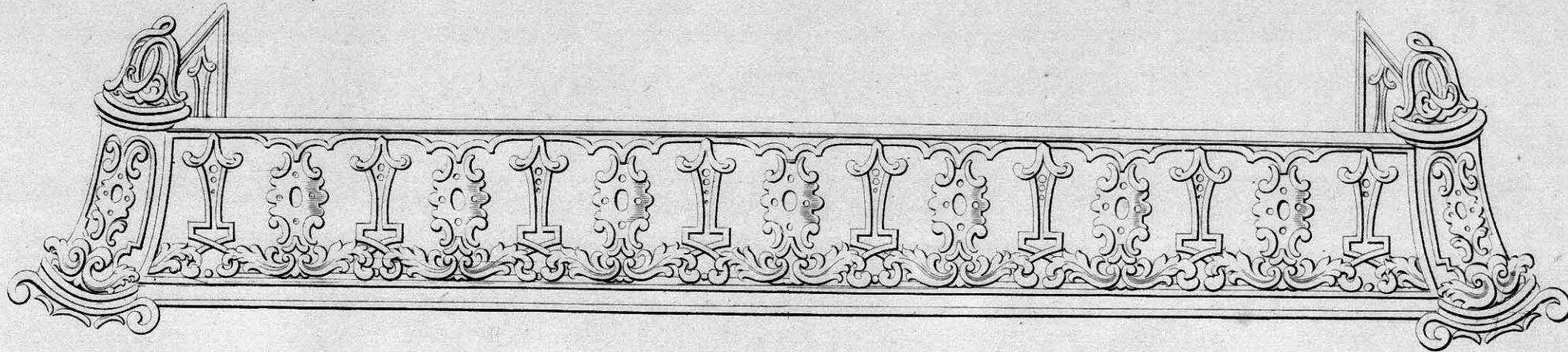

FENDER N^o 35. *Sizes 27_30_33_36_39_42_45 & 48 ins.*

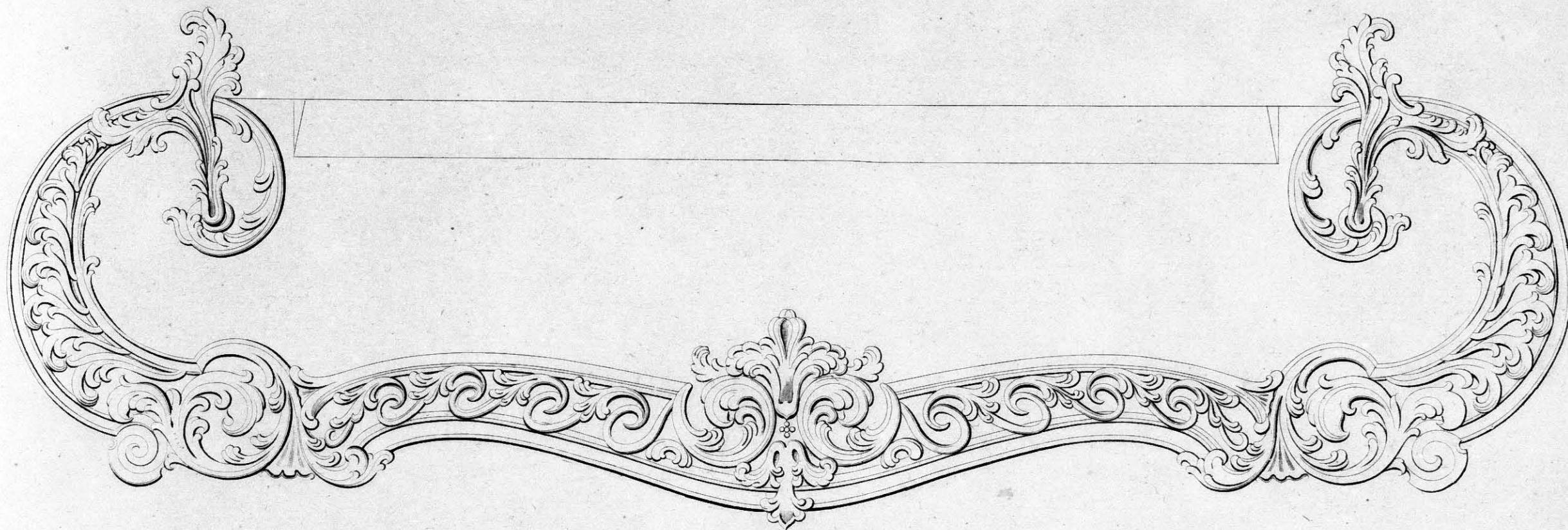

FENDER WITH STANDARDS N^o 34. *Sizes 45_48_51_54_57 & 60 ins.*

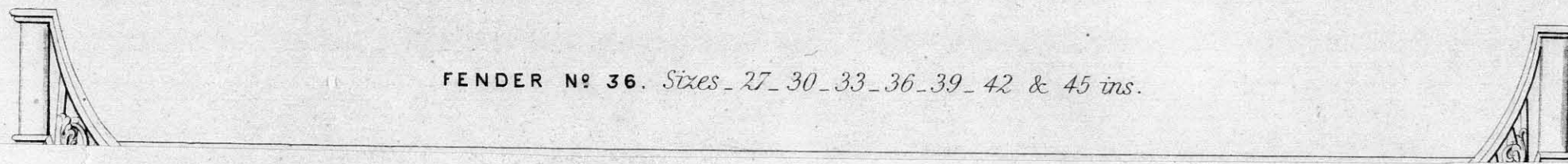

FENDER N^o 36. *Sizes 27_30_33_36_39_42 & 45 ins.*

Sizes 51_54_57_60_63 & 66 ins. Extent.

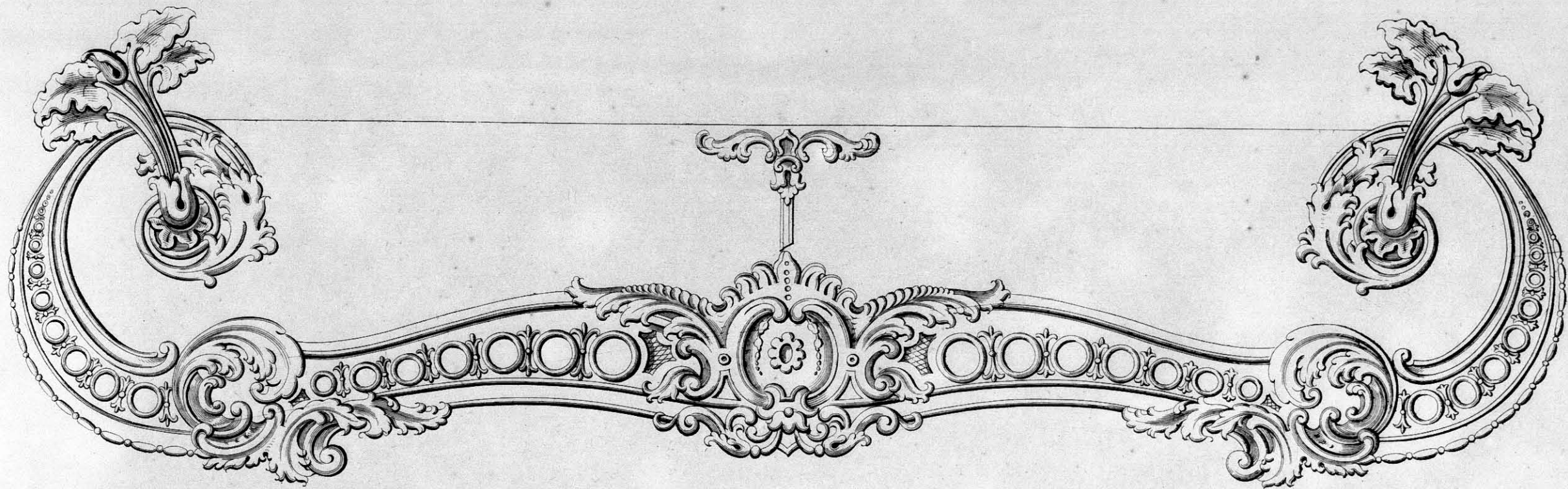

N^o 38 FENDER *with Standards*

Sizes 42. 45. 48. 51. 54. 57 and 60 ins Extent.

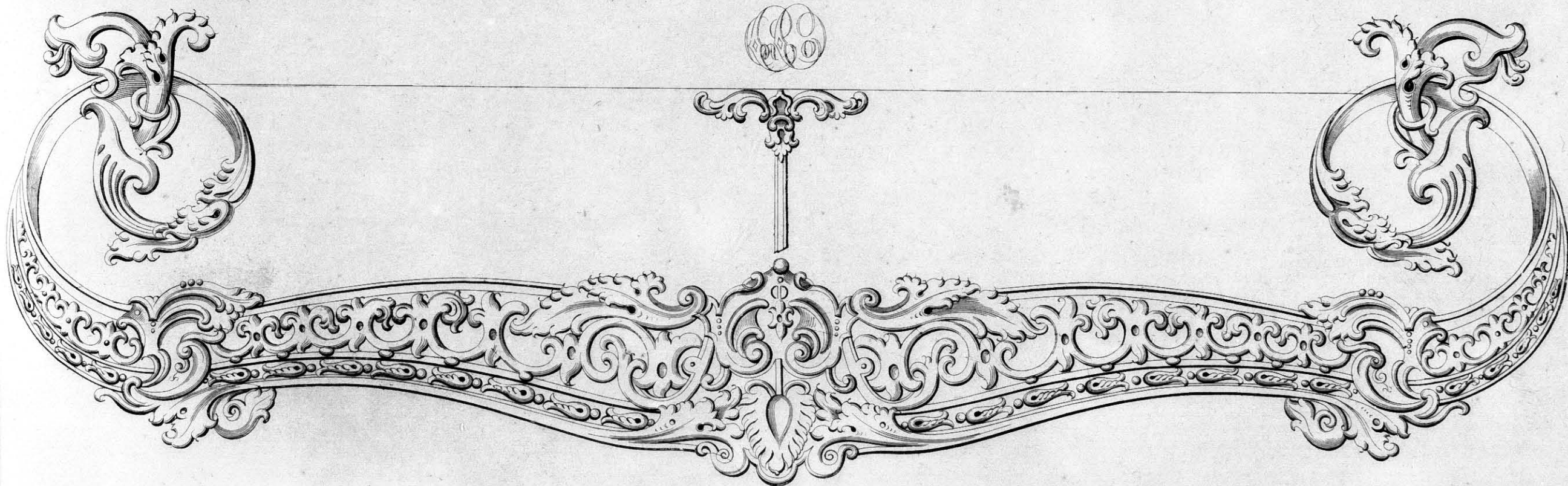

N^o 37 FENDER *with Standards*

Sizes 51. 54. 57. 60. 63 & 66 ins. Extent.

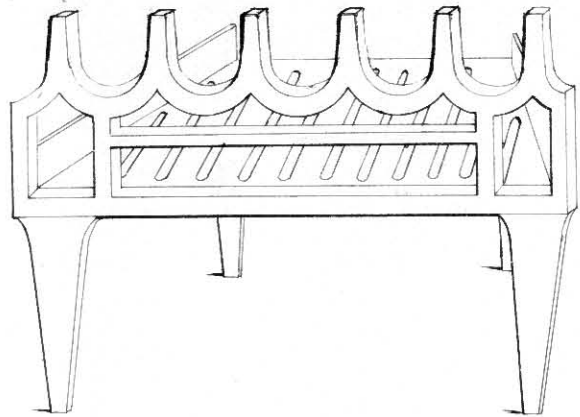

Cottage Grate with Spikes

18 inches wide.

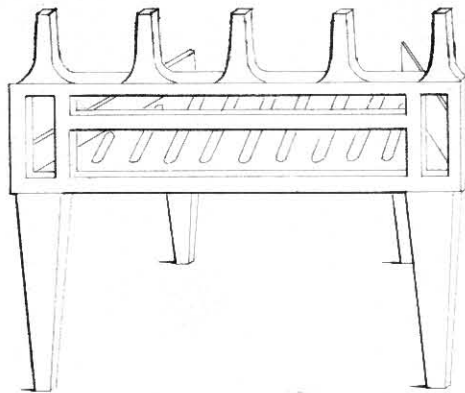

Cottage Grate with Spikes

15 inches wide.

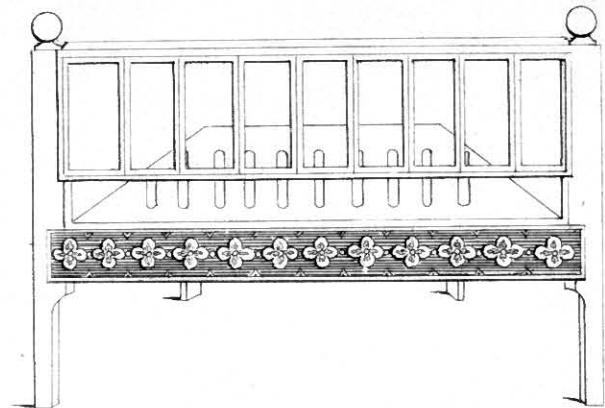

Cottage Grate N° 1

16 & 19 inches wide.

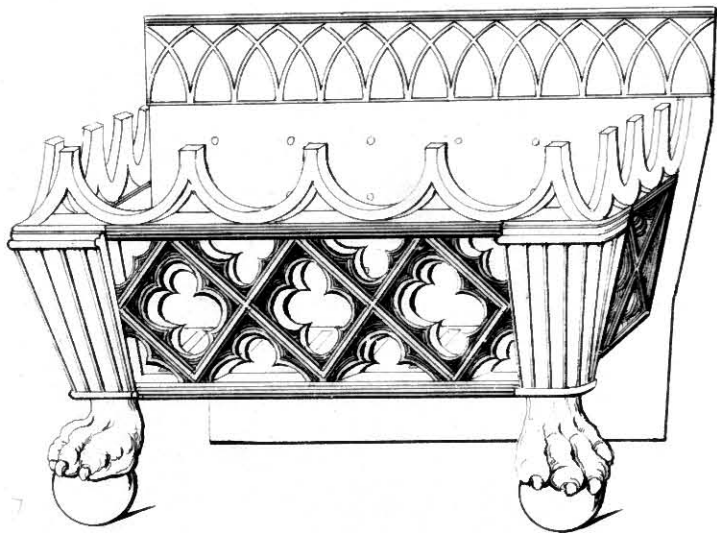

Gothic Hall Stove.

Sizes N° 0. 1. 2.

13 3/4 17 1/2 20 3/4 In. Wide at Back

*11 1/2 - 14 1/2 - 17 1/2 -
14 - 16 1/2 - 19 1/2 -*

(R)

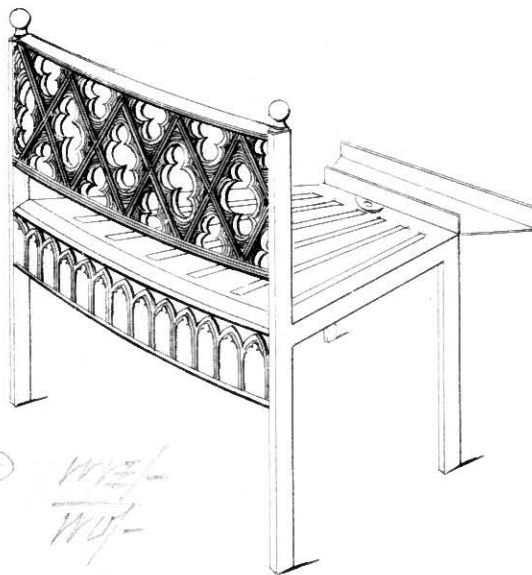

Cottage Grate N° 3.

Sizes 15 & 18 inches wide.

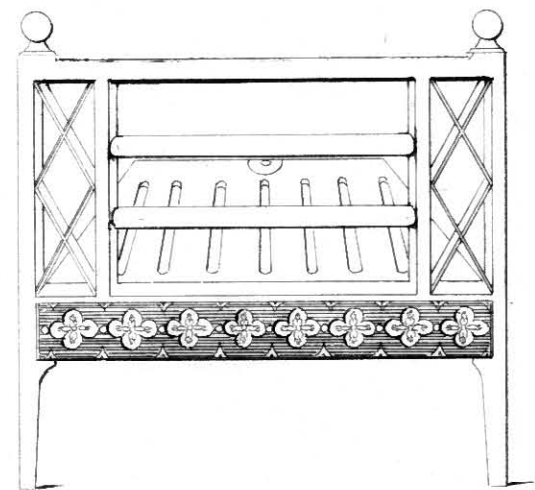

Cottage Grate N° 2

Sizes 15 & 18 inches wide.

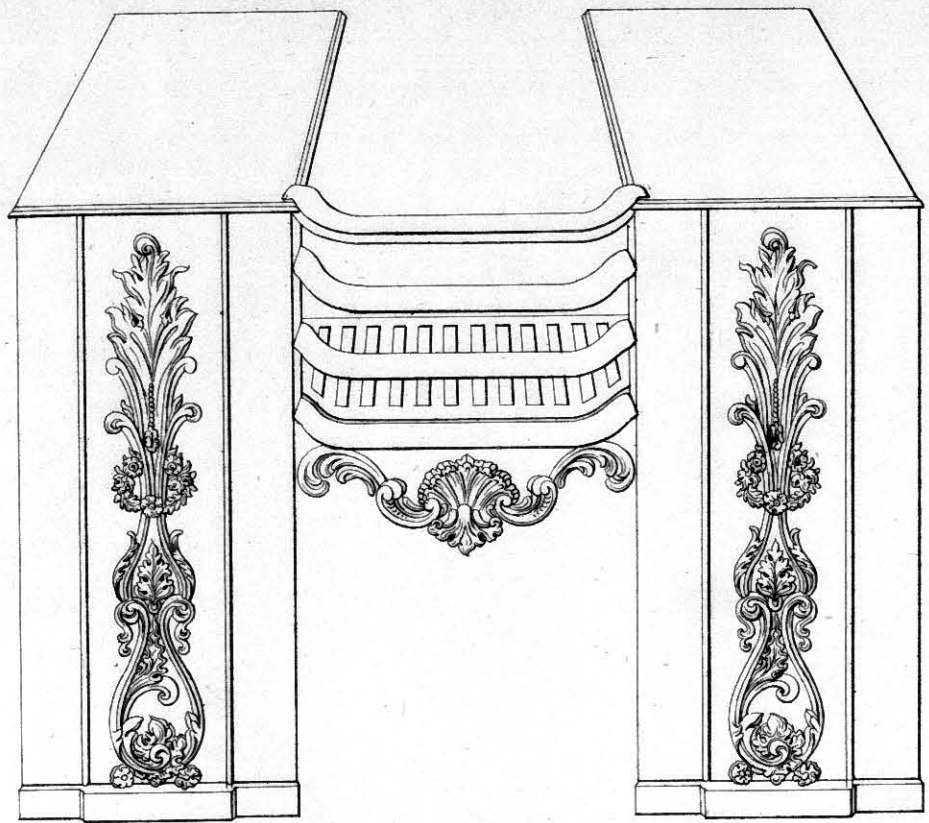

Elliptic Sham Stove,
Sizes 16 to 40 Inches.

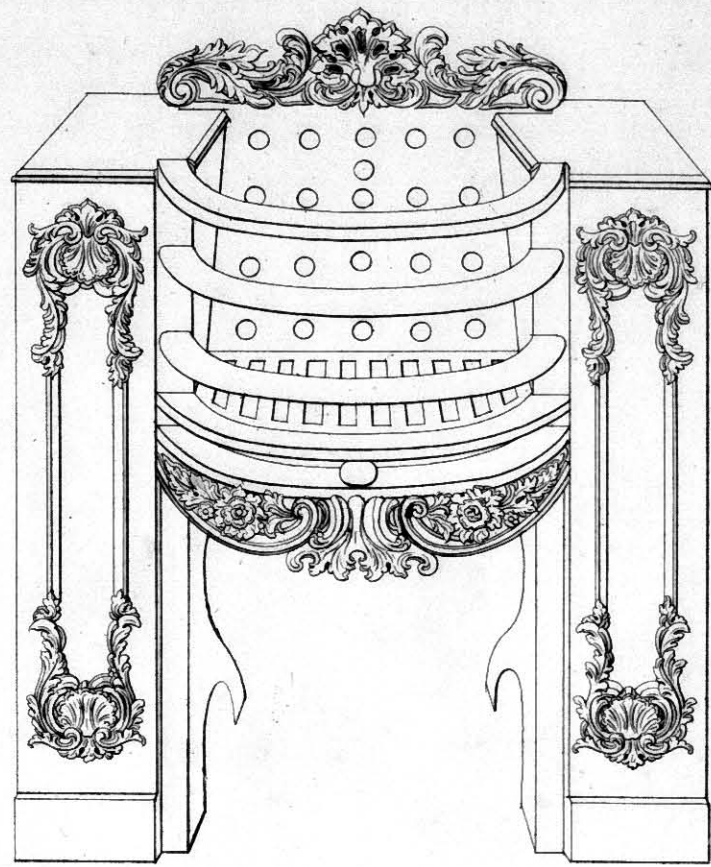

Improved Rumford Stove,
Sizes 14 to 26 Inches.

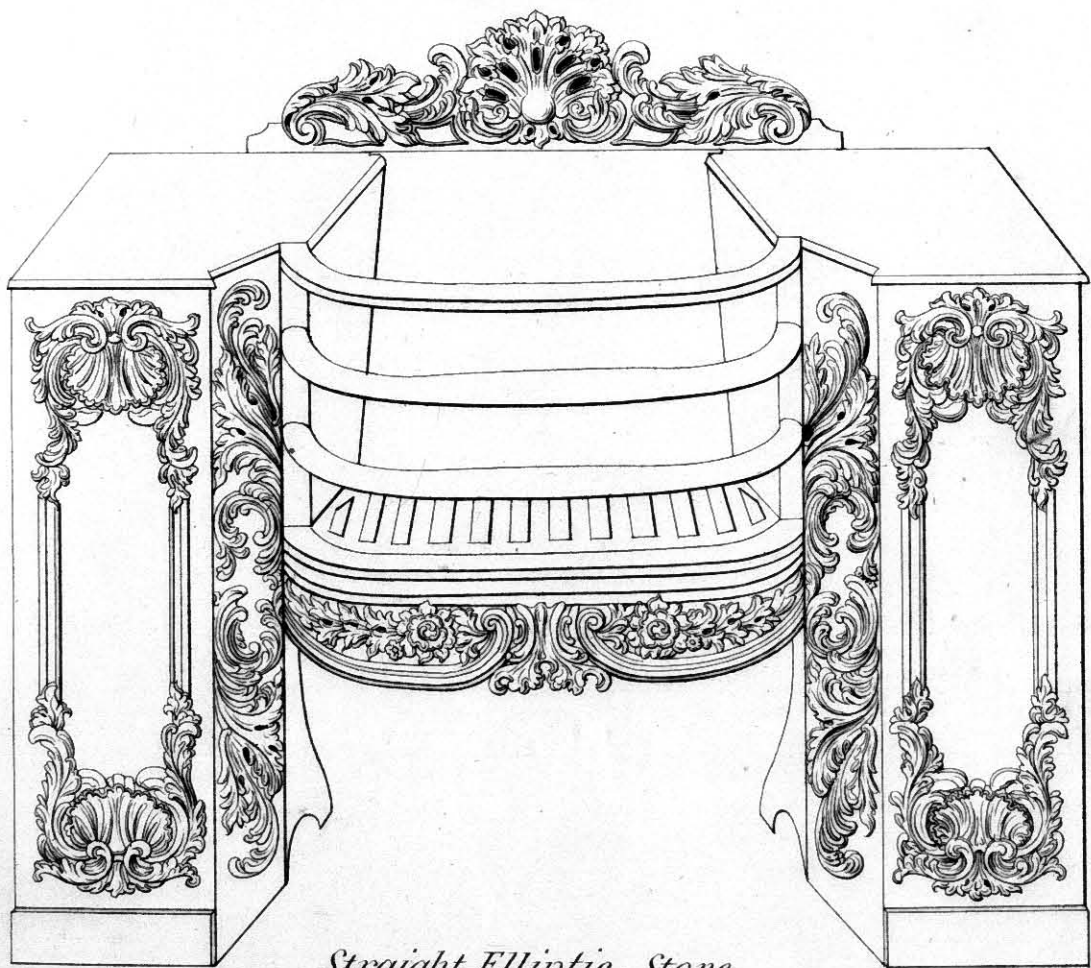

Straight Elliptic Stove,
Sizes 16 to 40 Inches.

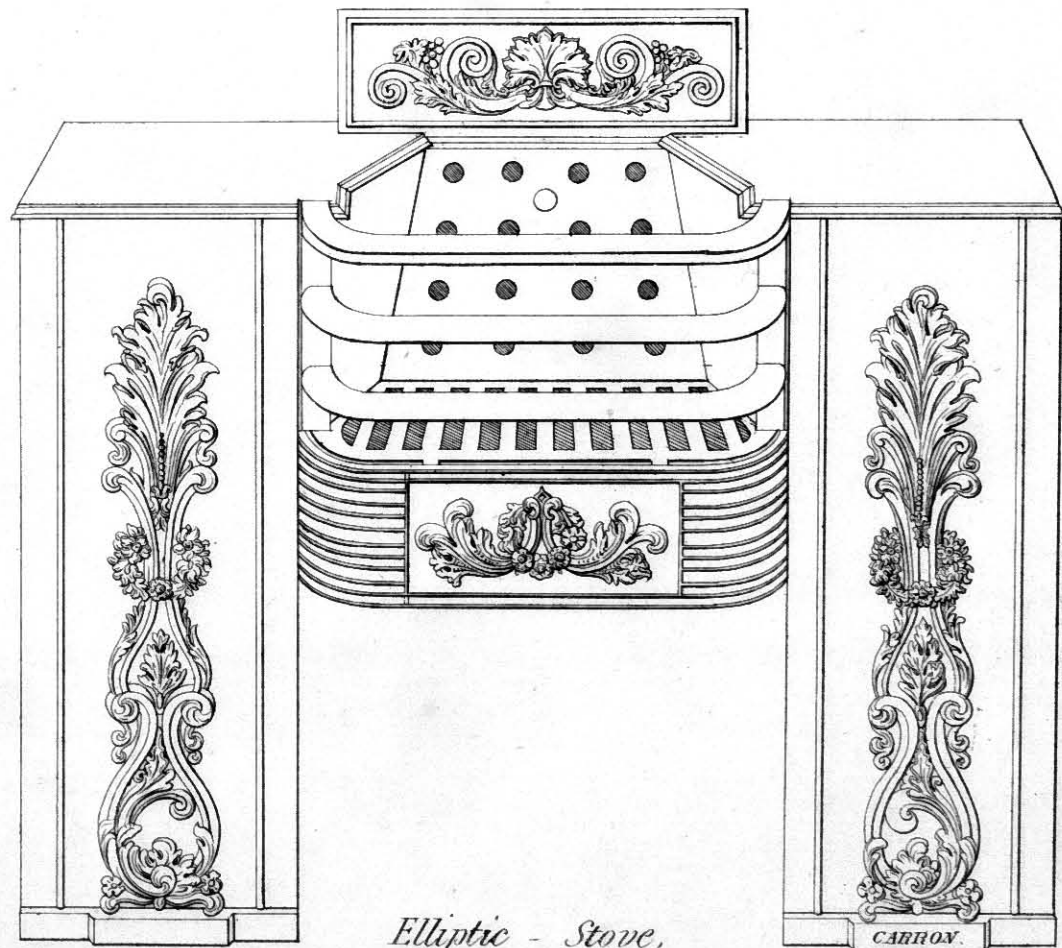

Elliptic - Stove,
Sizes 16 to 36 Inches.

CARRON

Tailors Stove N^{os} 1. 2.
Width inside 14. 24. In.
Depth .. 12. 12. ..
Height .. 23½. 25¾.

New Pattern Heater Stove, N^{os} 1. 2. 3.
Width 10. 10¾. 11½ In.
Length 12½. 15. 18 In.
Height 26. 26. 30½ In.

Square Fluted Stove, N^{os} 1. 2. 3. 4.
Size at the door 6. 7. 8. 10 Ins.

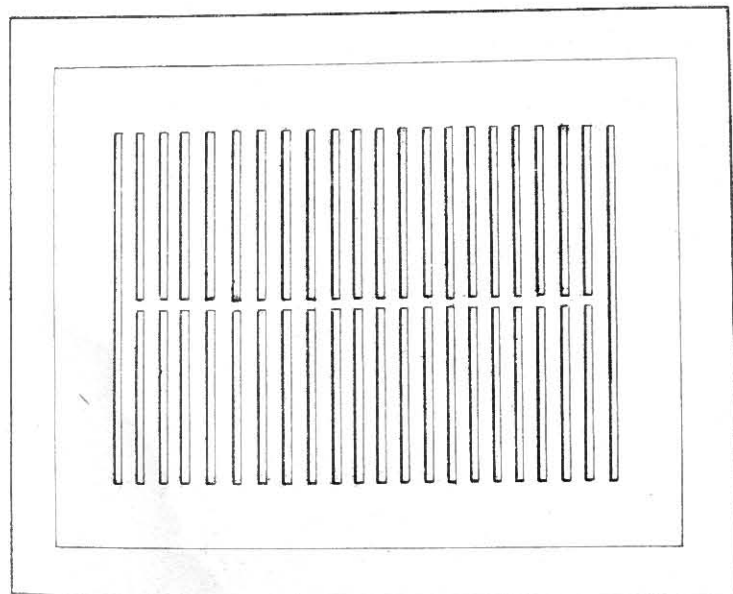
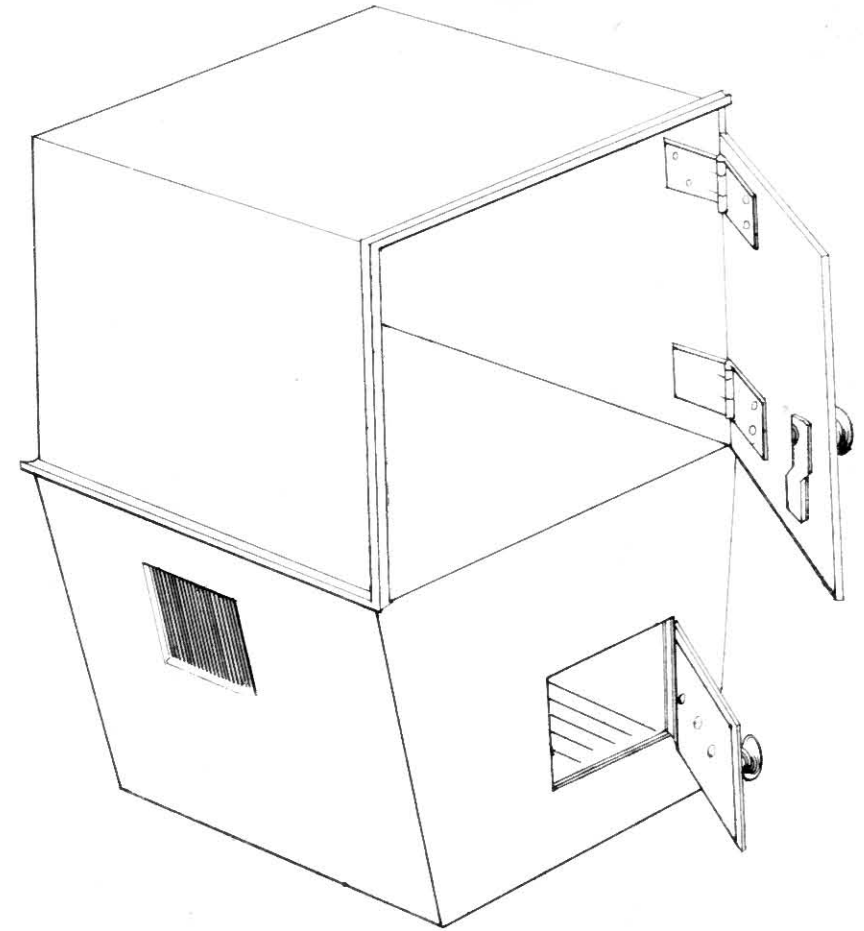
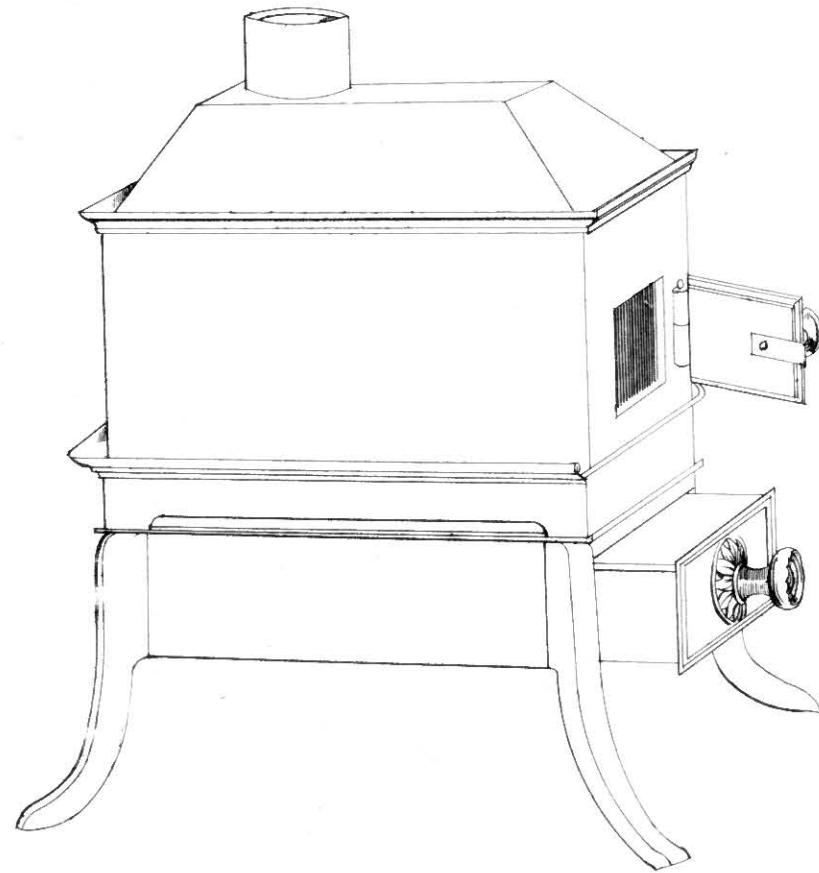
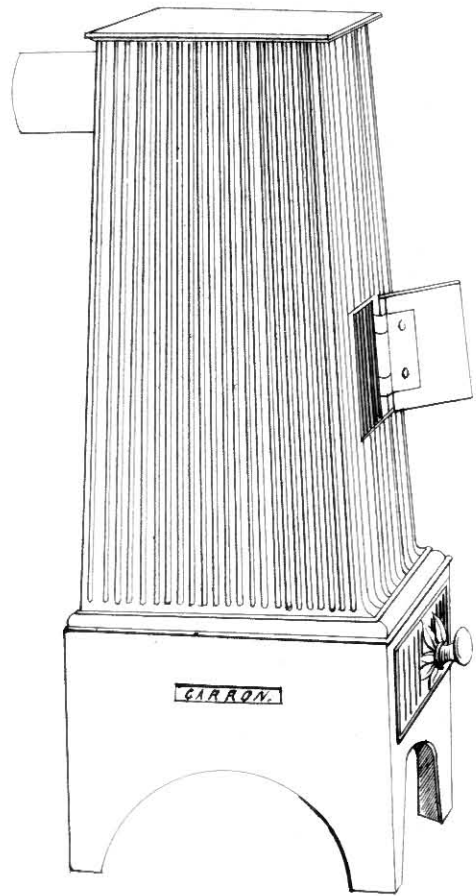

Black or Bright Ash Grate & frame.
Sizes outside 14x12 to 24x18 In.
Ash Grates only 12 to 28 In. long.

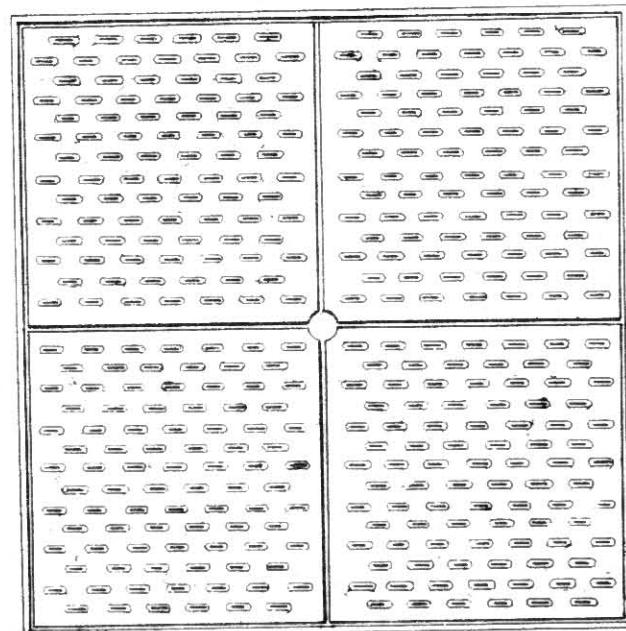

Kiln Plate with long holes.
Size 18 Inches square.

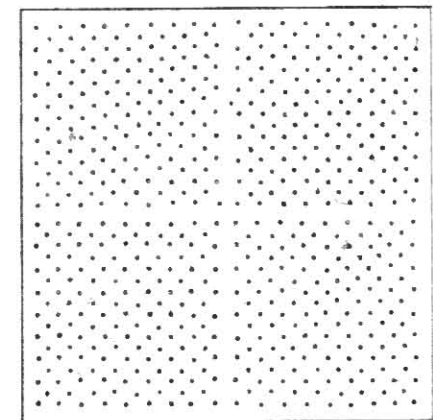

Kiln Plate with round holes.
Size 12 Inches square.

Plain Square Shop Stoves

Sizes N^o 1, 2, 3, 4 with plain flat tops or open tops & Covers 7, 8, 9, 10 inches wide
 " 1, 2, 3 with pipes at top
 " 4 with or without Boiler on top with cover

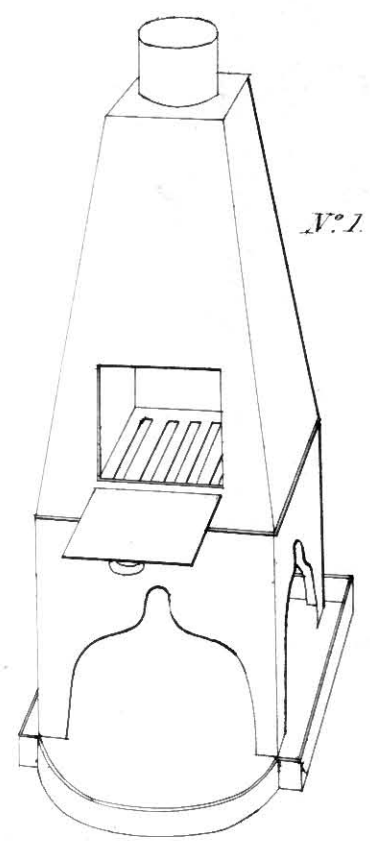

N^o 1

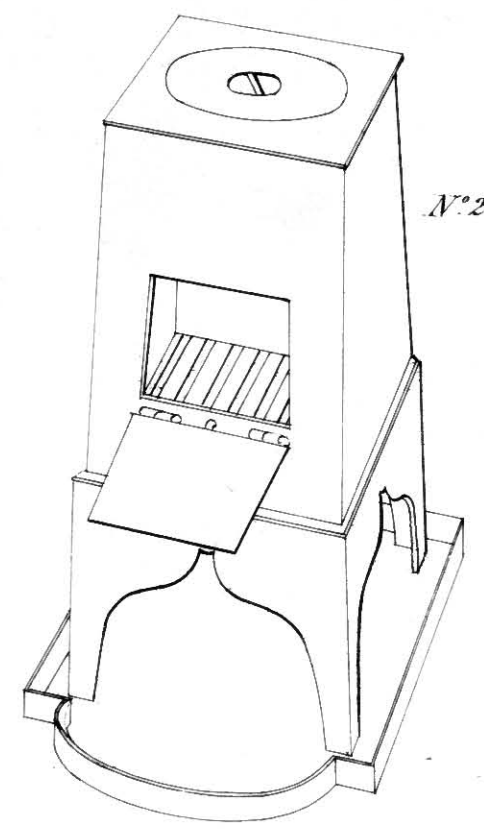

N^o 2

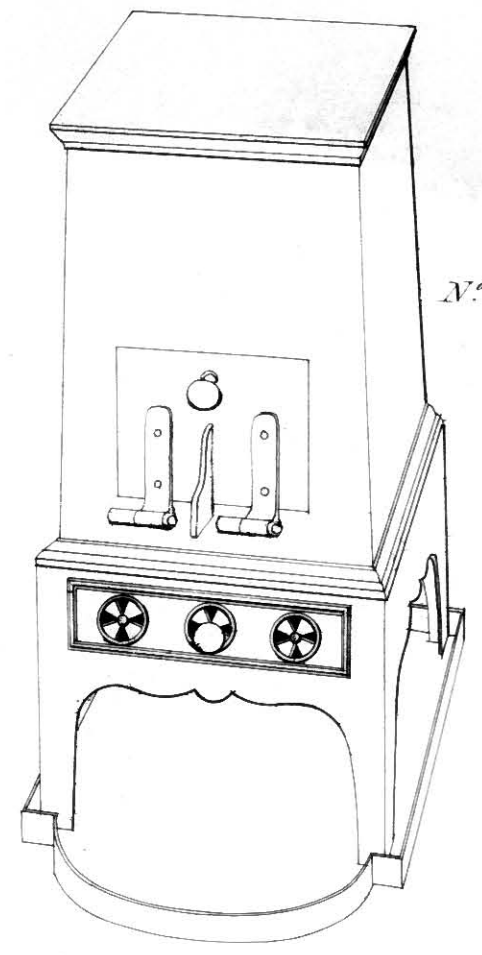

N^o 3

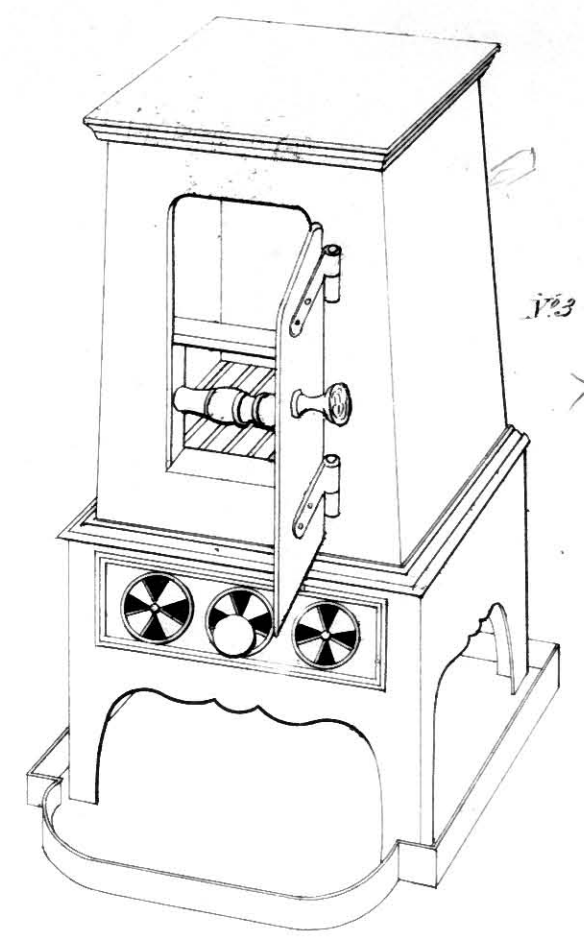

N^o 3 with Flans

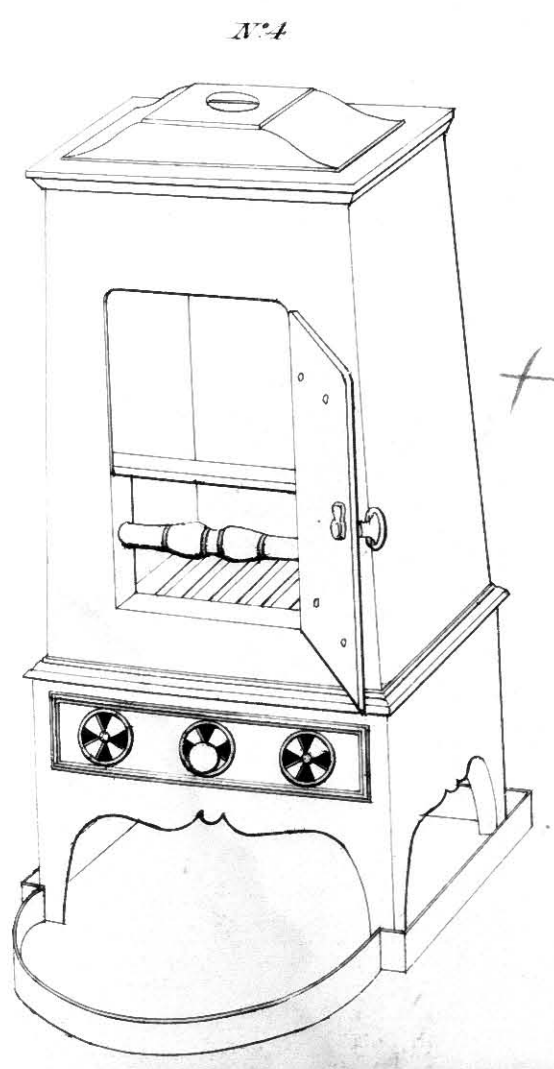

N^o 4

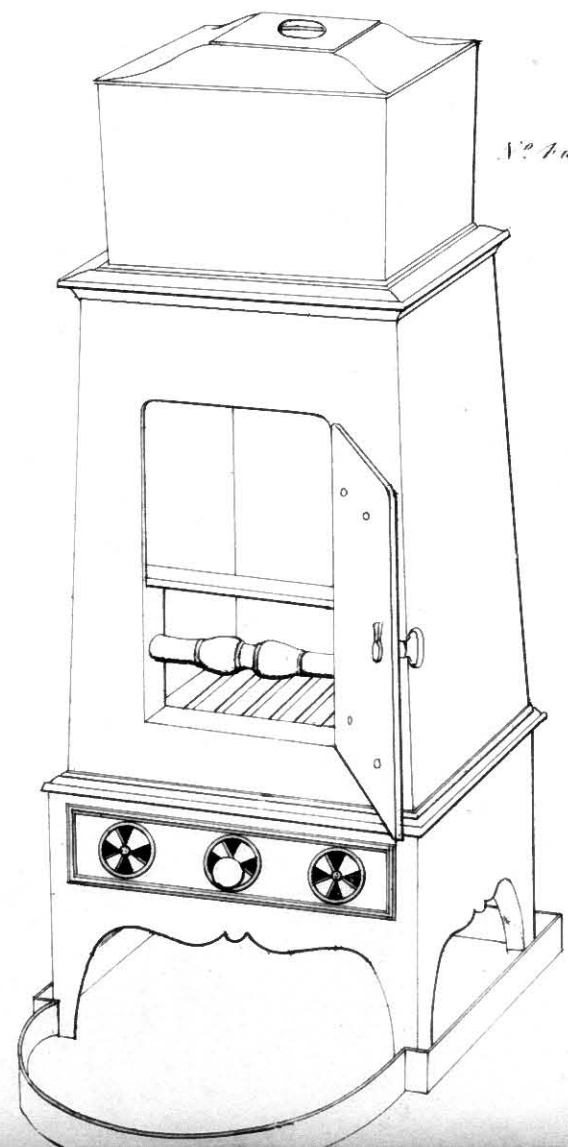

N^o 4 with Boiler

Heater Stove with Dog Feet.

Sizes N^{os} 1 2 3 4
 12 13 14 1/2 15 inches long
 9 10 1/2 11 12 " wide
 17 1/2 19 19 1/2 20 " high

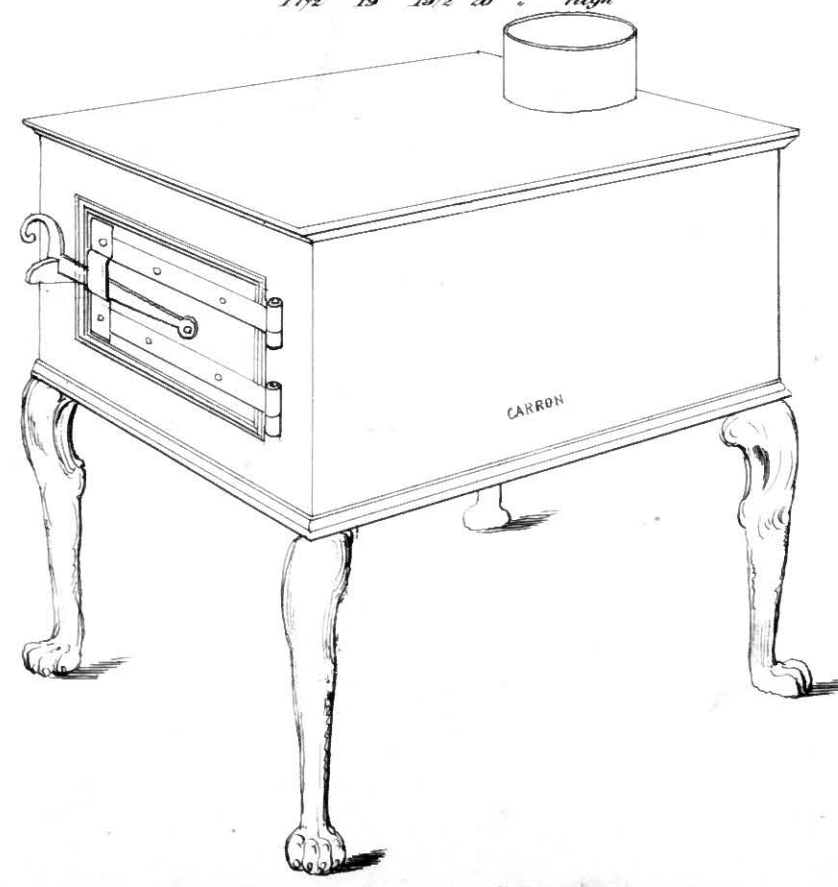

CARRON

Round Fluted Stoves N^{os} 1, 2, 3.

Diameter at Door 8, 8 1/2, 9 inches Height 27, 29, 34 inches
 Pipe either at top or behind.

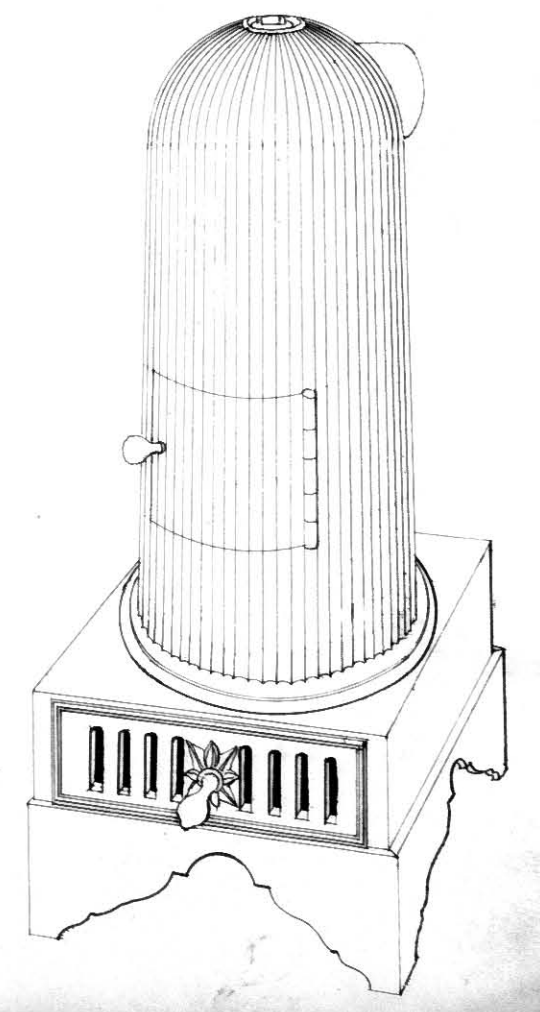

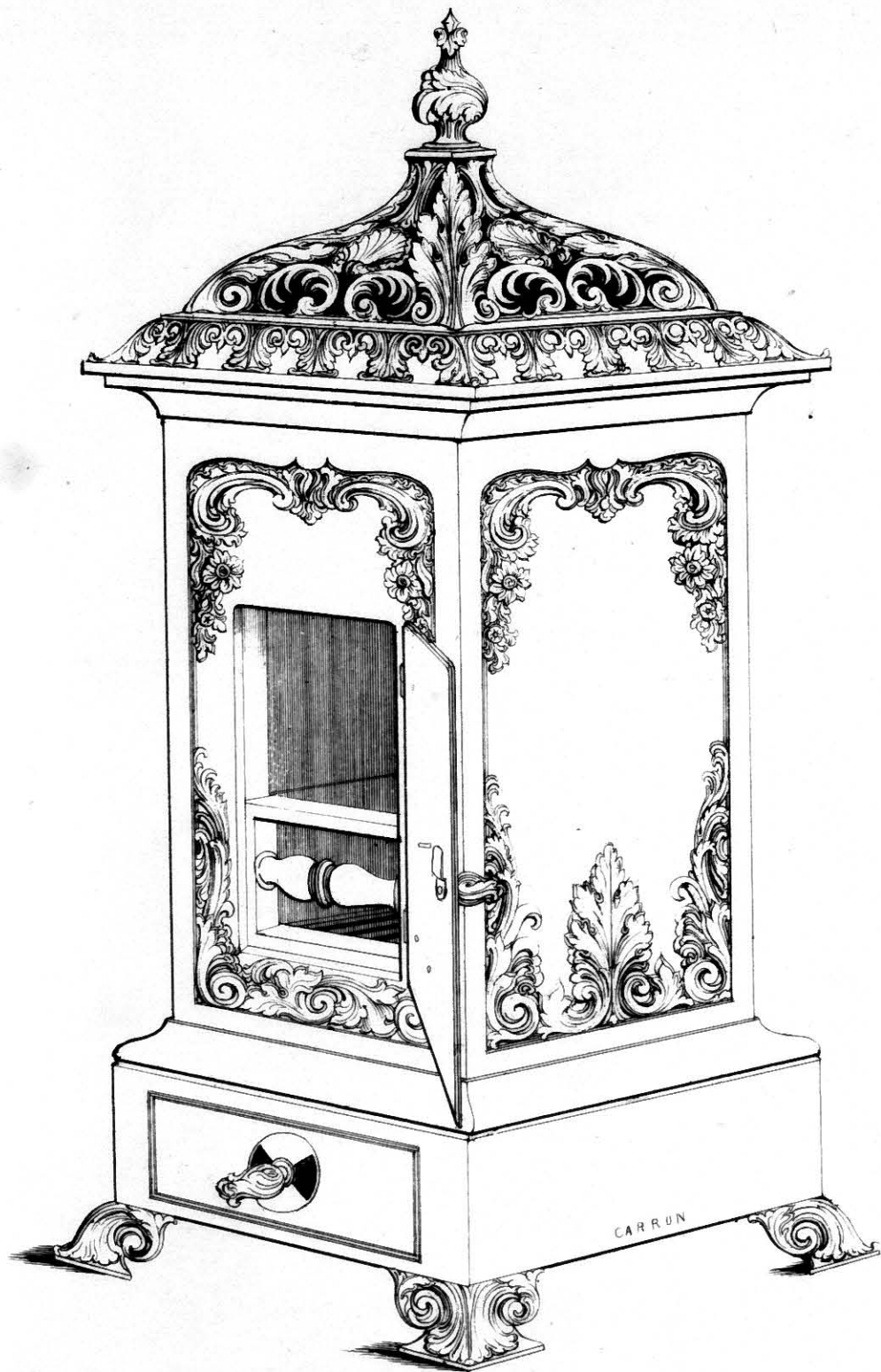

Hot Air Stove N^o 3.
with ascending flue, and Square Iron ventilator.
Sizes 10. 12. 14. 16. Inches Square.
with inside Cheeks & inside back.

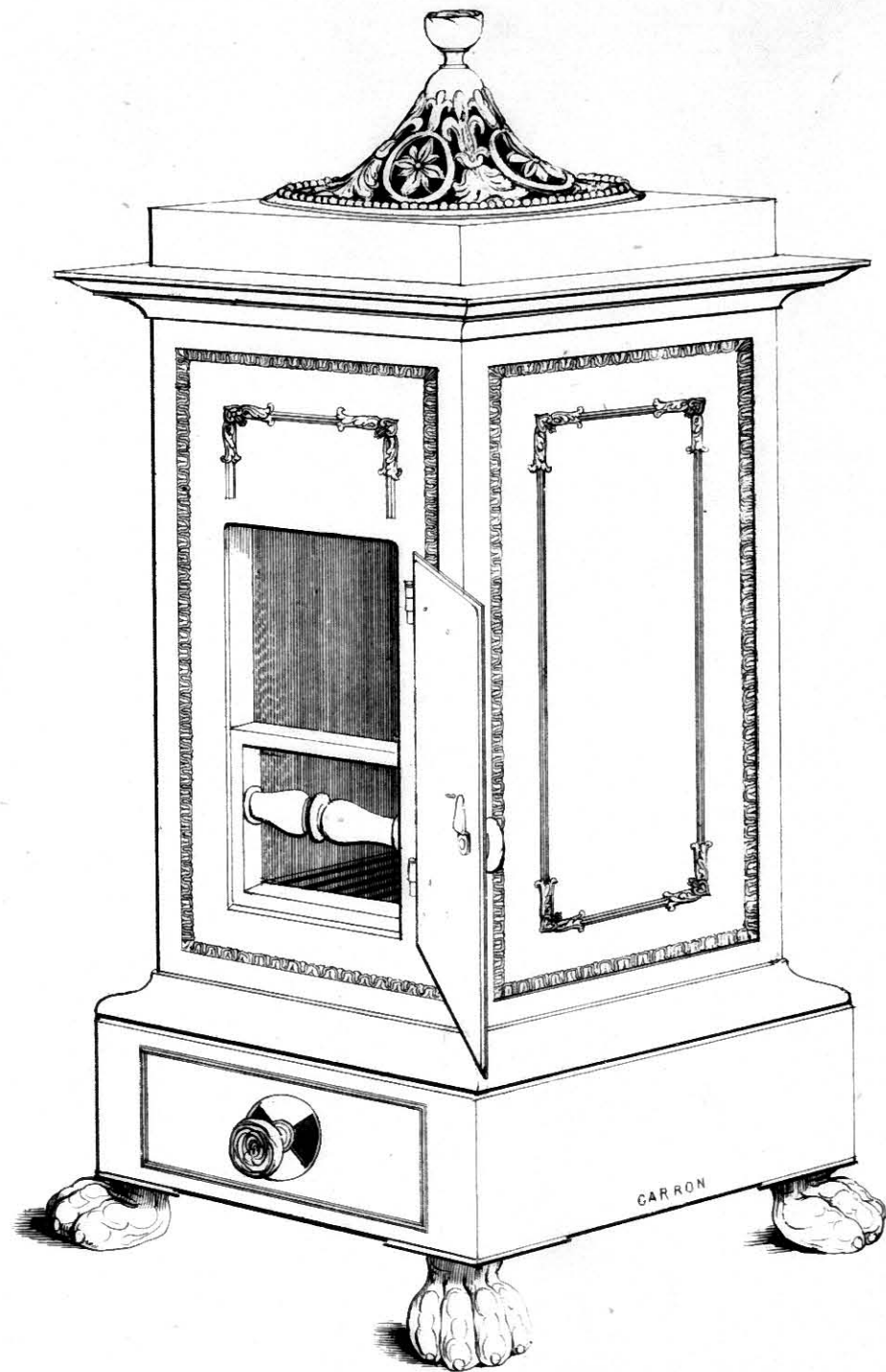

Hot Air Stove N^o 2.
with ascending flue, and Round Iron ventilator.
Sizes 9. 10. 12. 14. 16. 20. Inches Square.

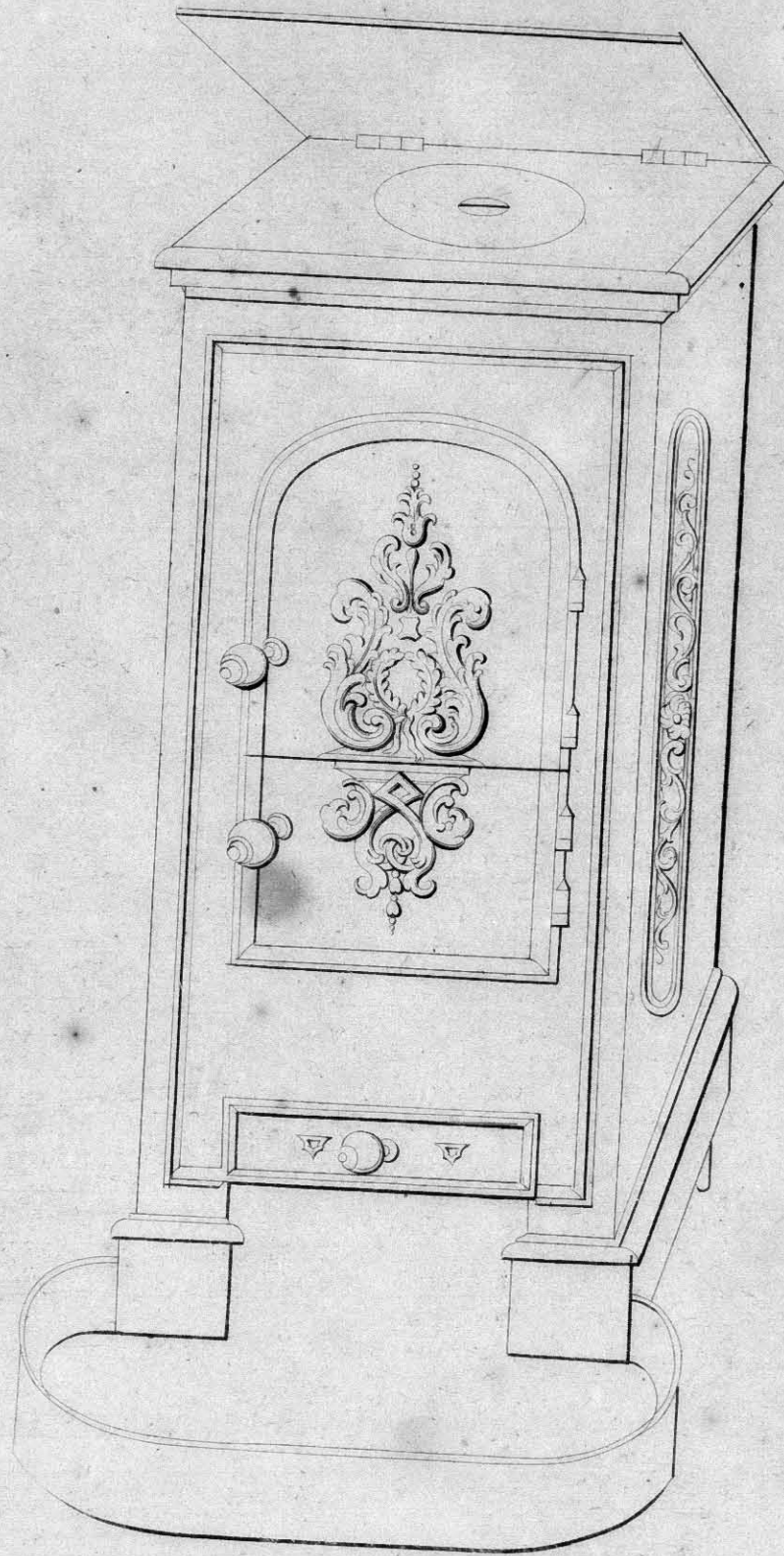

YACHT STOVE 10 12

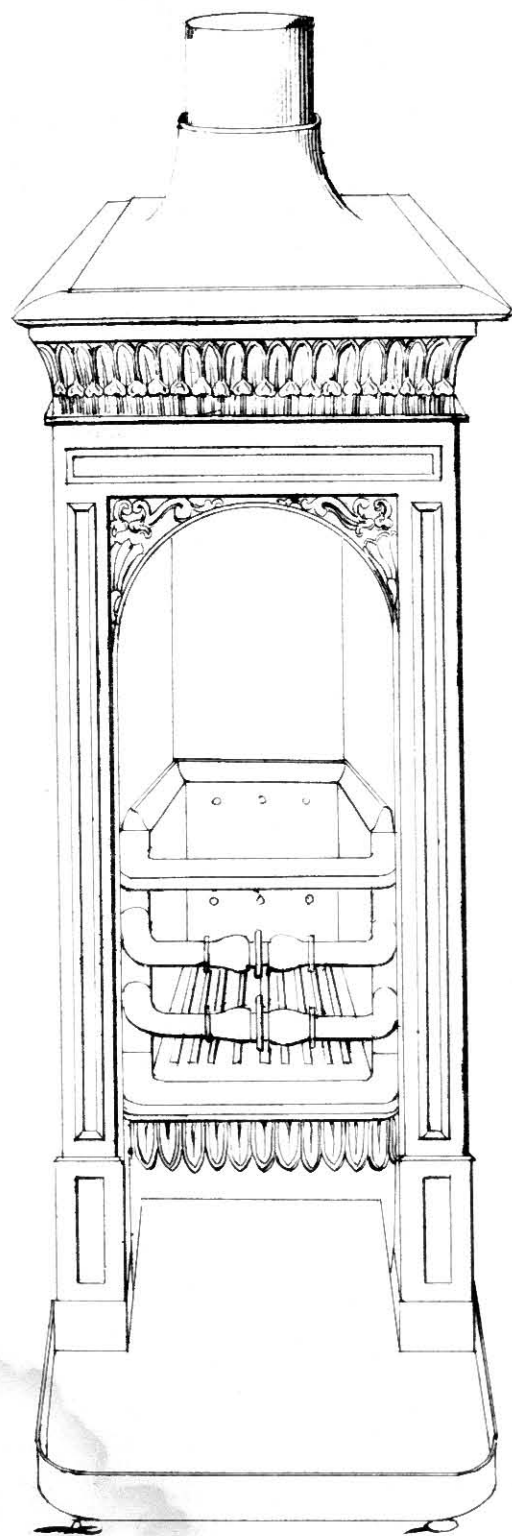

Cabin Stove either with pipe at top or behind.

N ^{os}	0.	1.	2.	3.
	7 ³ / ₄	8 ³ / ₈	9 ³ / ₄	10 ³ / ₄
	In. wide inside.			
	36 ¹ / ₂	39.	40.	42.
	In. high.			

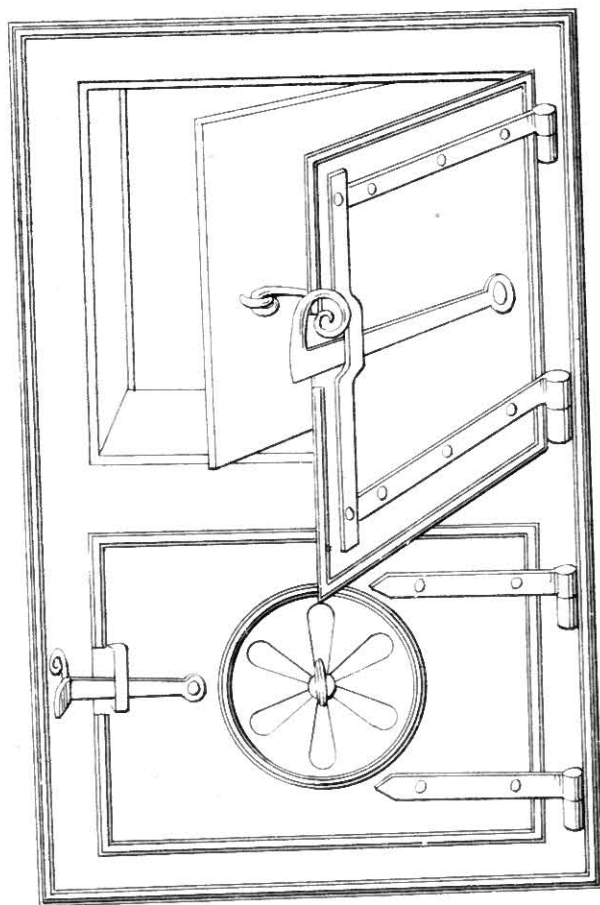

Double Door & Frame for Hot Houses &c

Sizes 14. 16 inches wide.

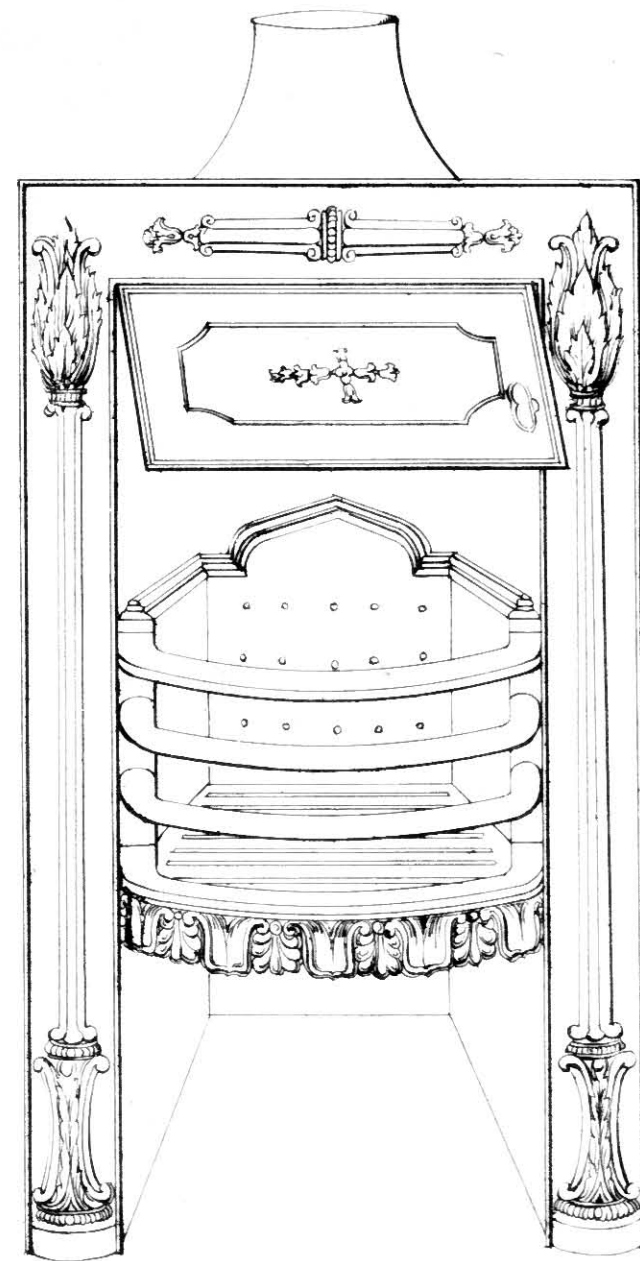

Boat Stove

N ^{os}	0	1	2	3
	16	18	20	22
	in. wide outside			
	10	12	14 ¹ / ₂	16 ¹ / ₂
	inside			
	32 ¹ / ₂	35	37 ¹ / ₂	39 ¹ / ₂
	high			

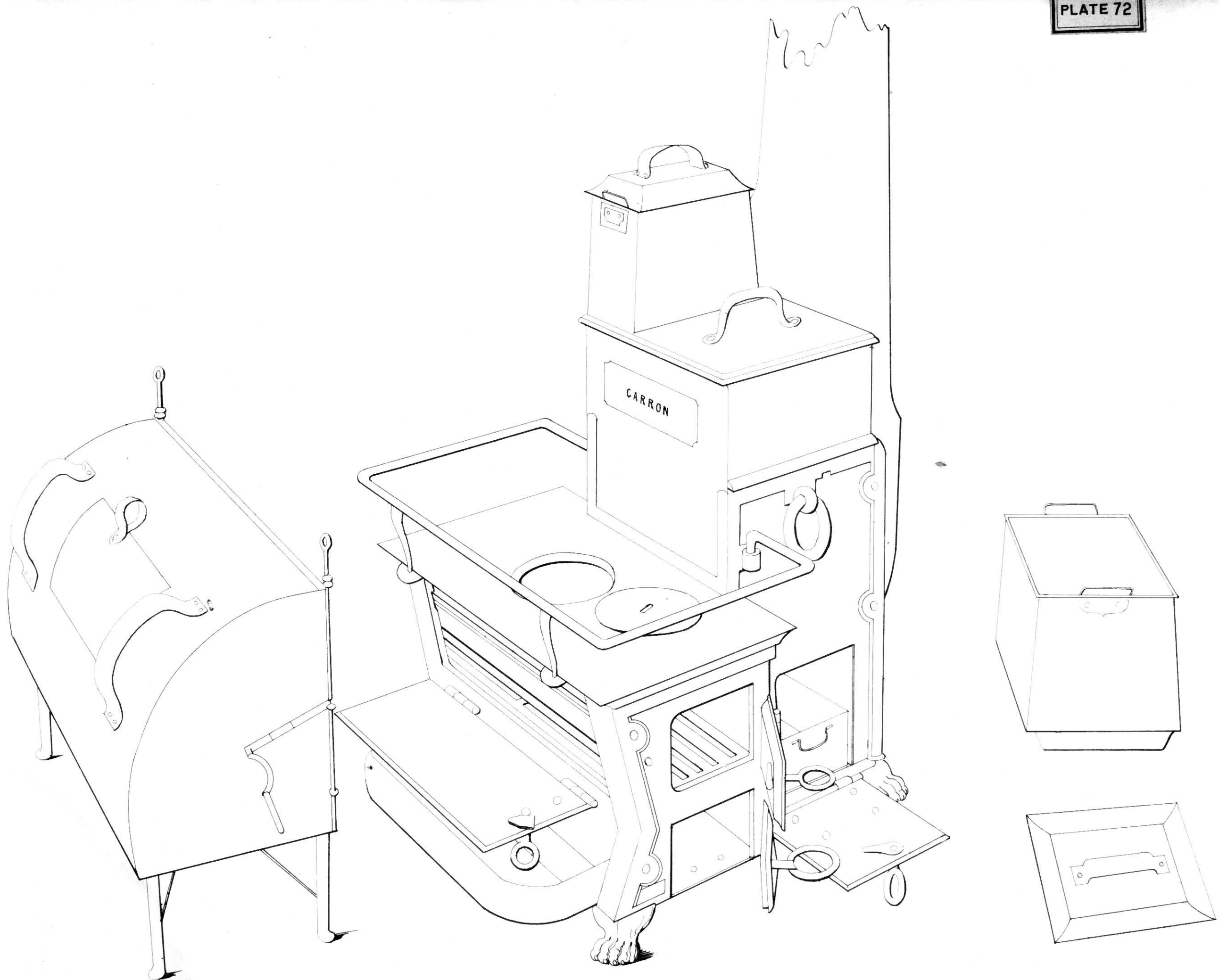

Safety Ship Hearths with Ovens and Boilers

Sizes 14 inches

16, 20 inches

*With Tin Plate Vegetable Steamers, Pudding Pan
6" & 8"*

*With Tin Plate Dutch Oven, Vegetable Steamers
Pudding Pan &c.*

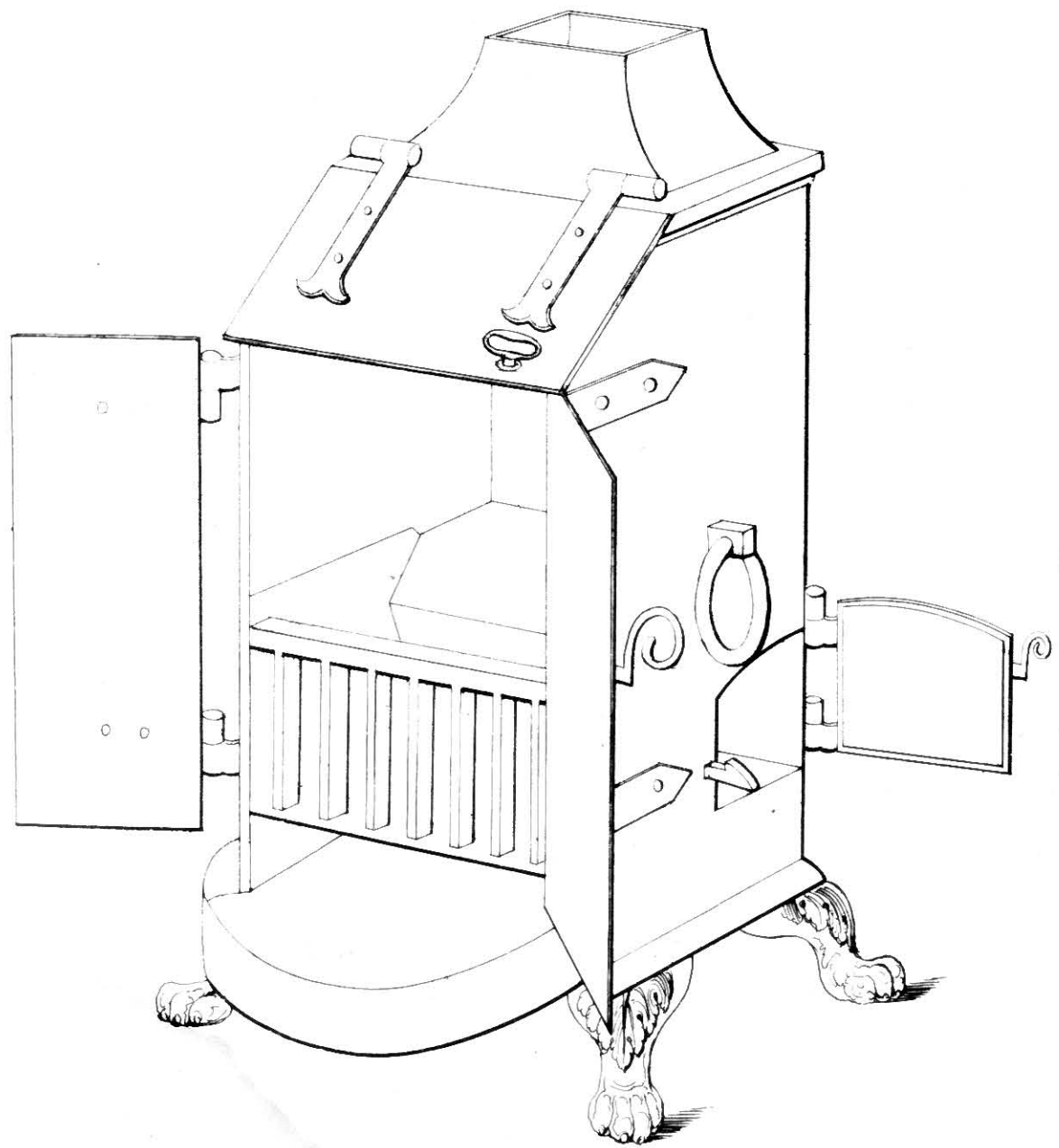

NP Ship Hearths

Sizes 10, 12, 14, 16 inches, with Ovens.

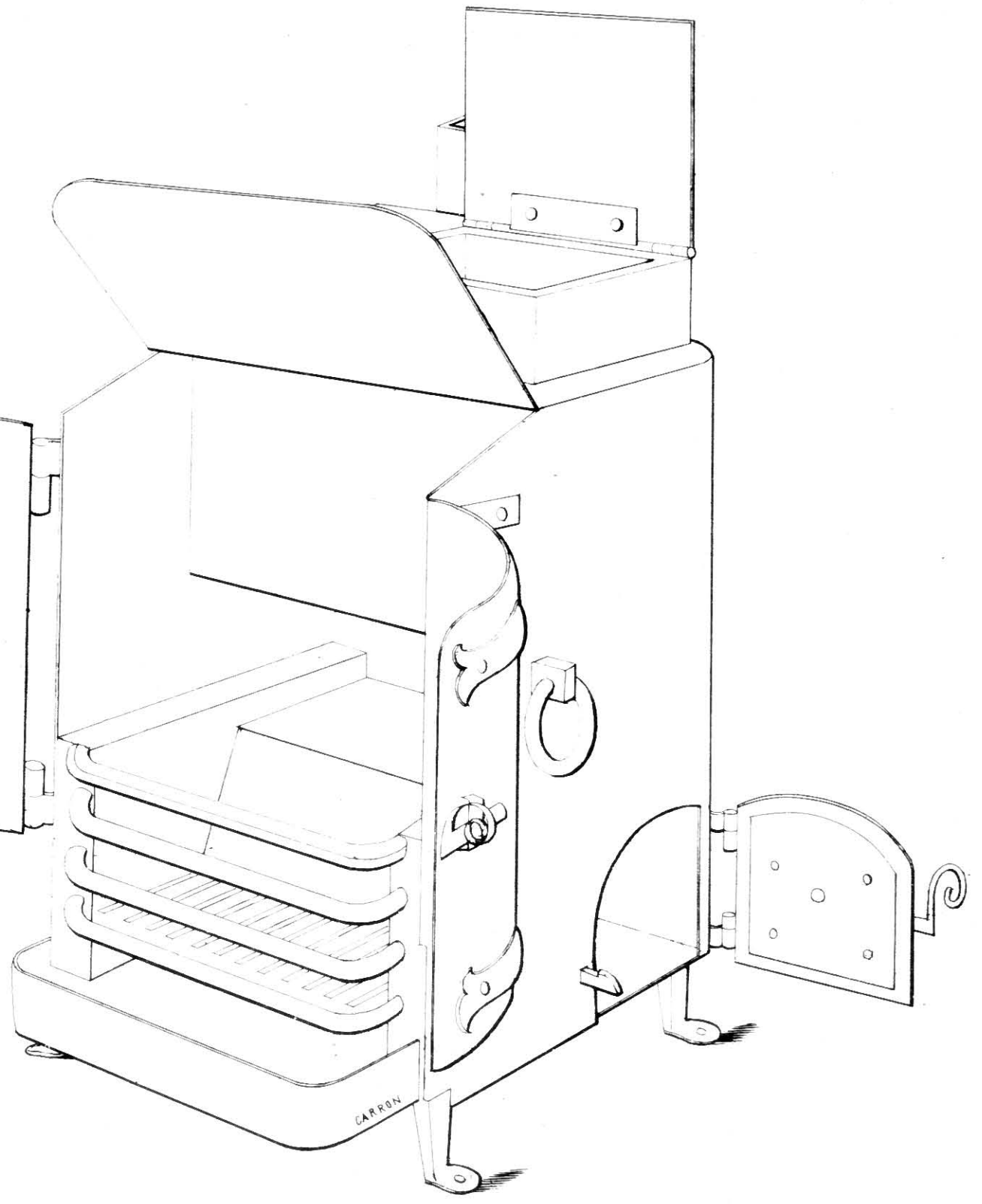

Liverpool Ship Hearths

*N^o 1, 2, with Ovens and Boilers.
15, 18 inches wide*

N^o 1.

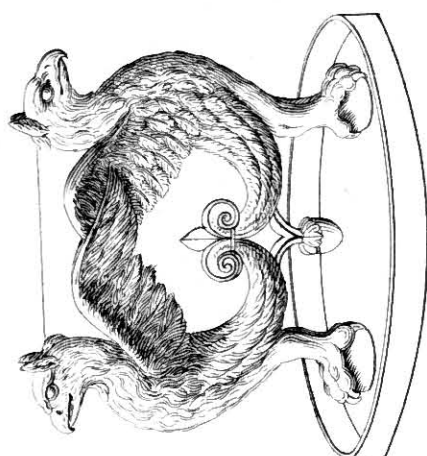

N^o 2

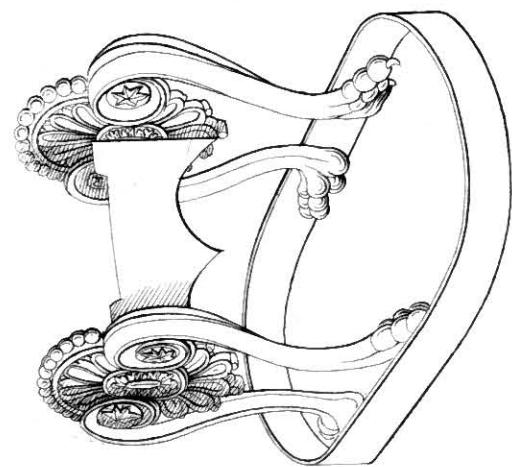

N^o 4

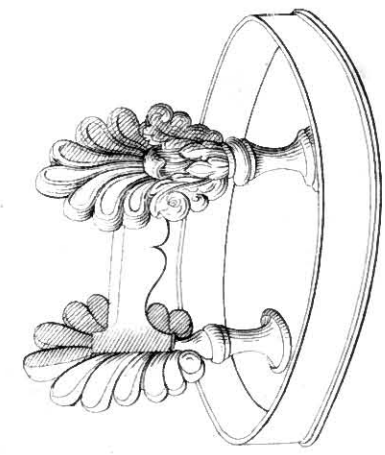

N^o 8.

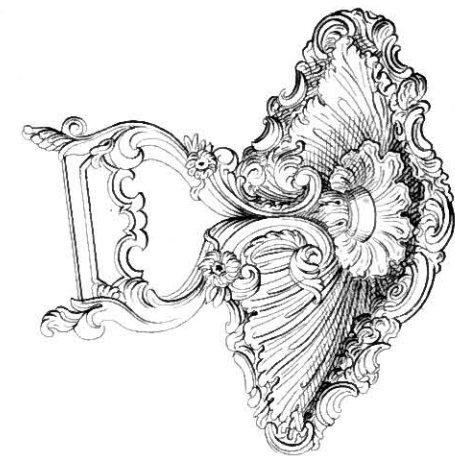

N^o 7.

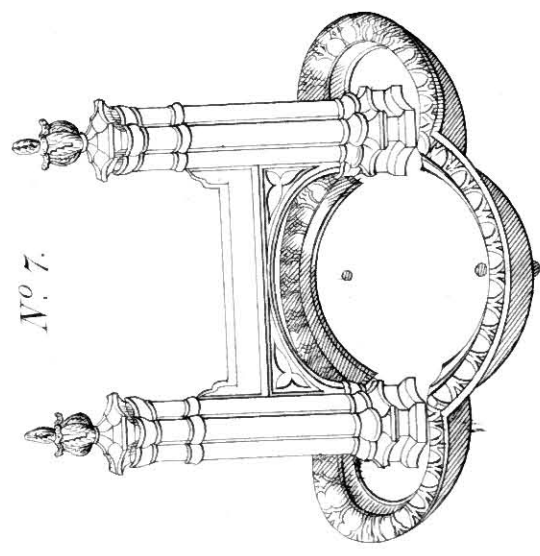

N^o 5.

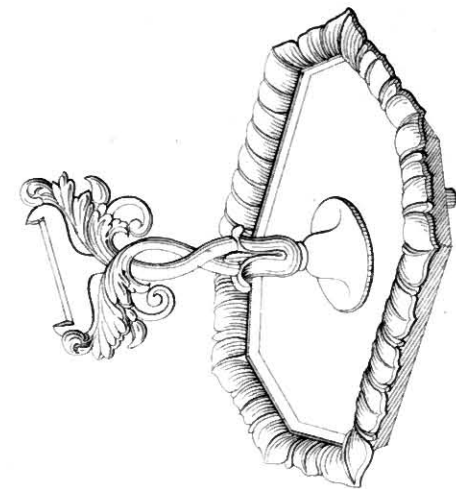

N^o 3.

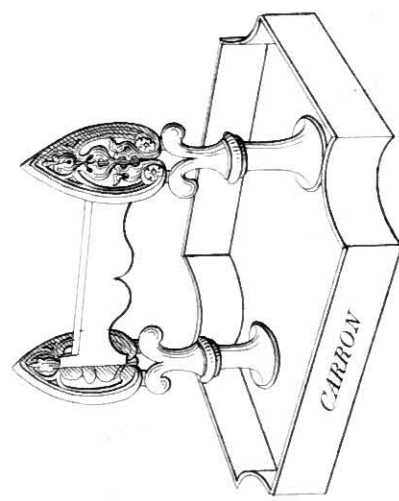

N^o 6

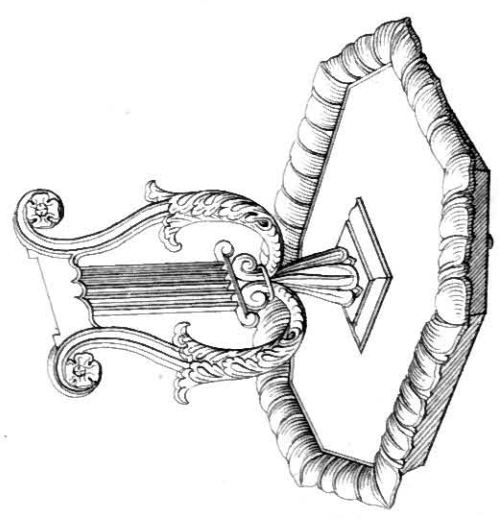

N^o 1.

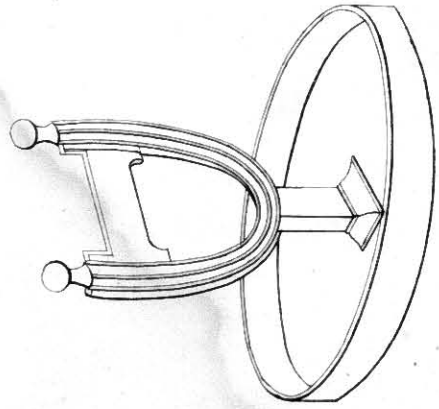

N^o 2.

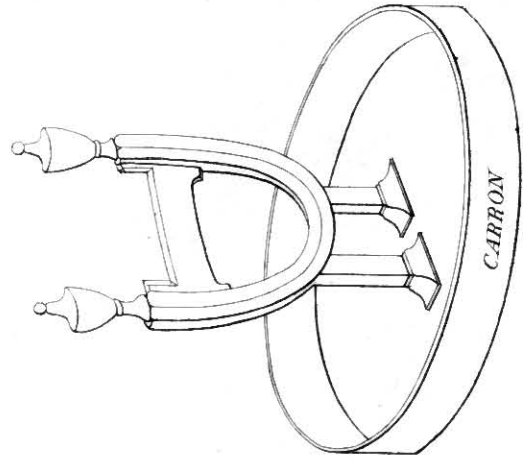

N^o 4.

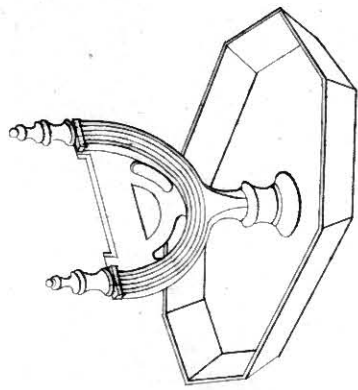

N^o 0.

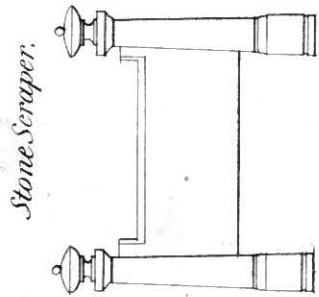

Wall Scraper.

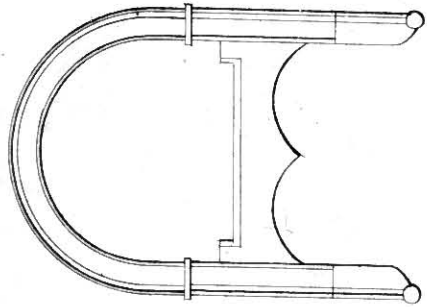

N^o 00.

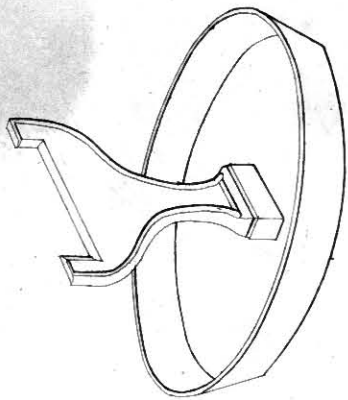

N^o 8.

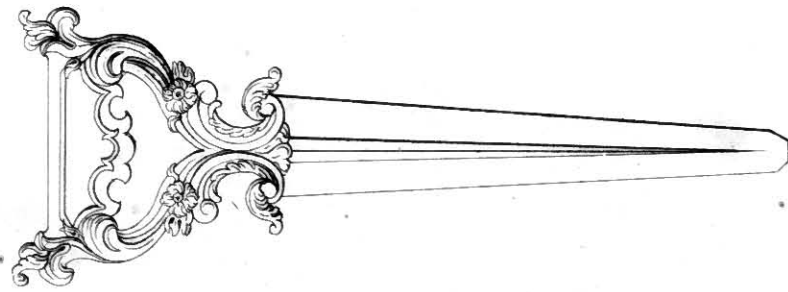

Garden Scrapers.

N^o 6.

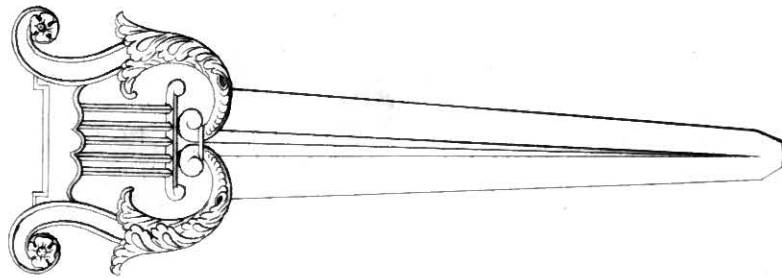

N^o 2.

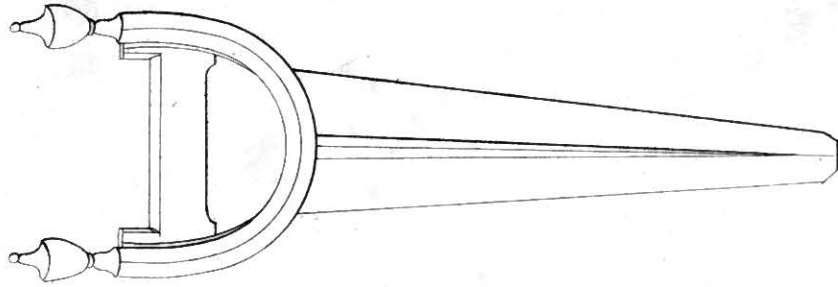

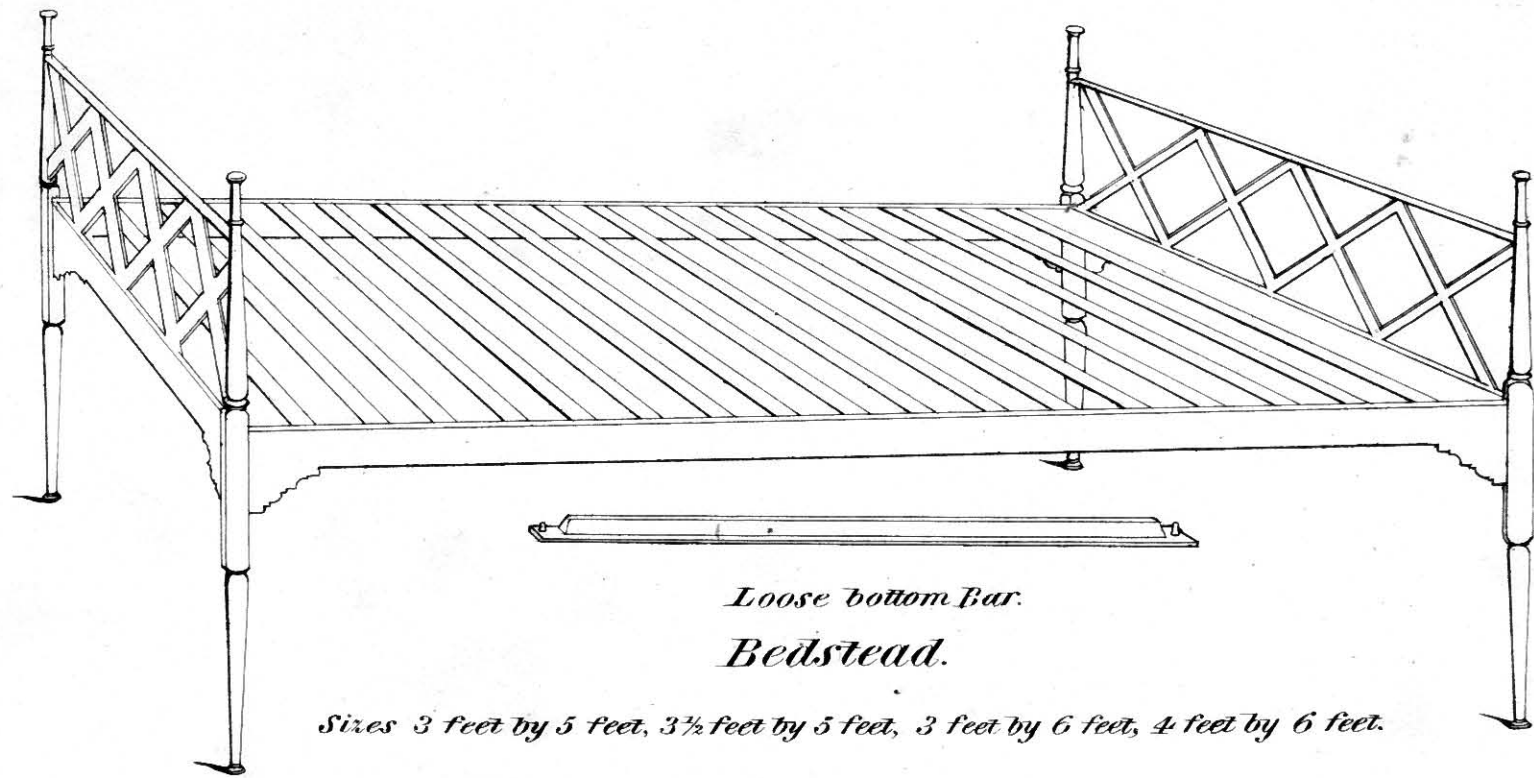

*Loose bottom Bar.
Bedstead.*

Sizes 3 feet by 5 feet, 3½ feet by 5 feet, 3 feet by 6 feet, 4 feet by 6 feet.

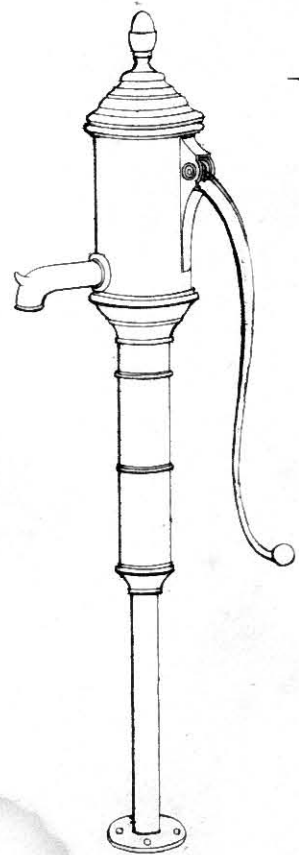

Pump.

3 & 3½ Inches.

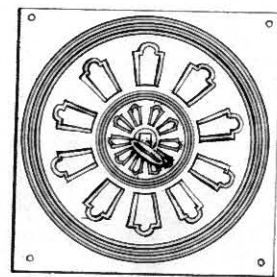

Ventilator.

6. 9 & 12 inches sq^{re}

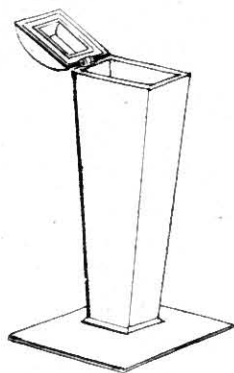

Socket

For Clothes Post.

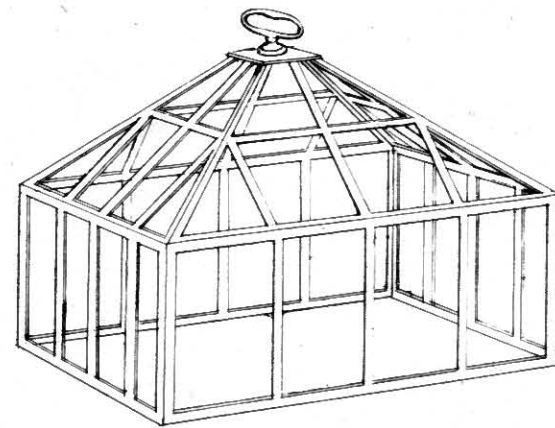

Hand Glass Frame.

Sizes 12. 18. 20. 22. 24 Inches Square.



Clothes Post.

N^o 1.

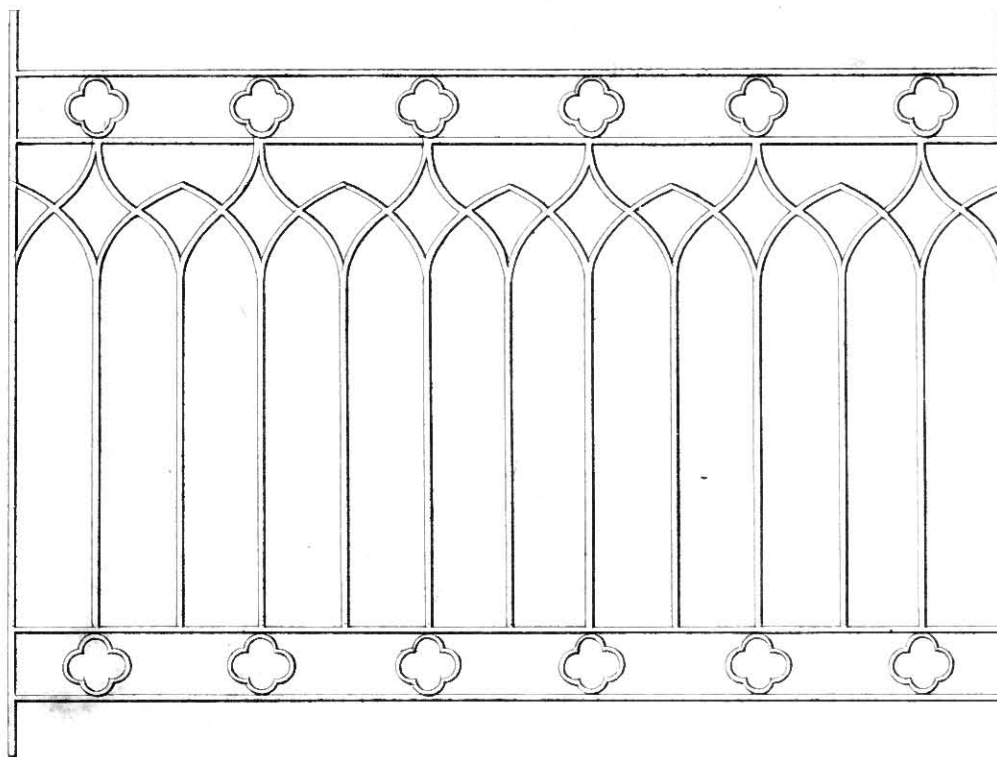
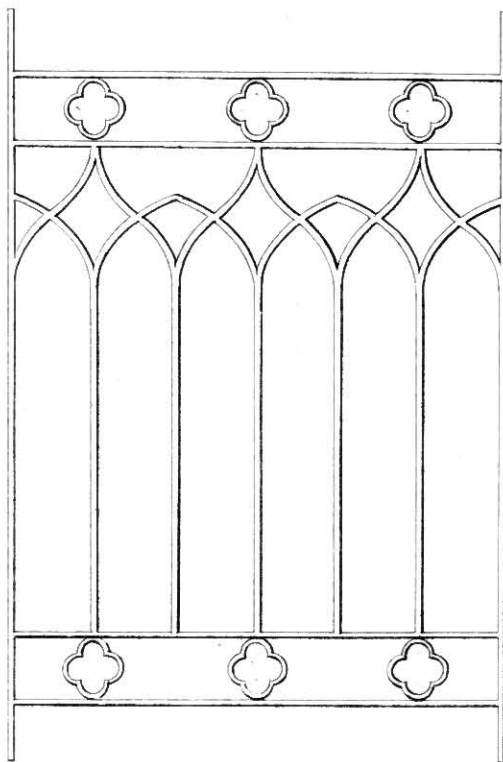

N^o 2.

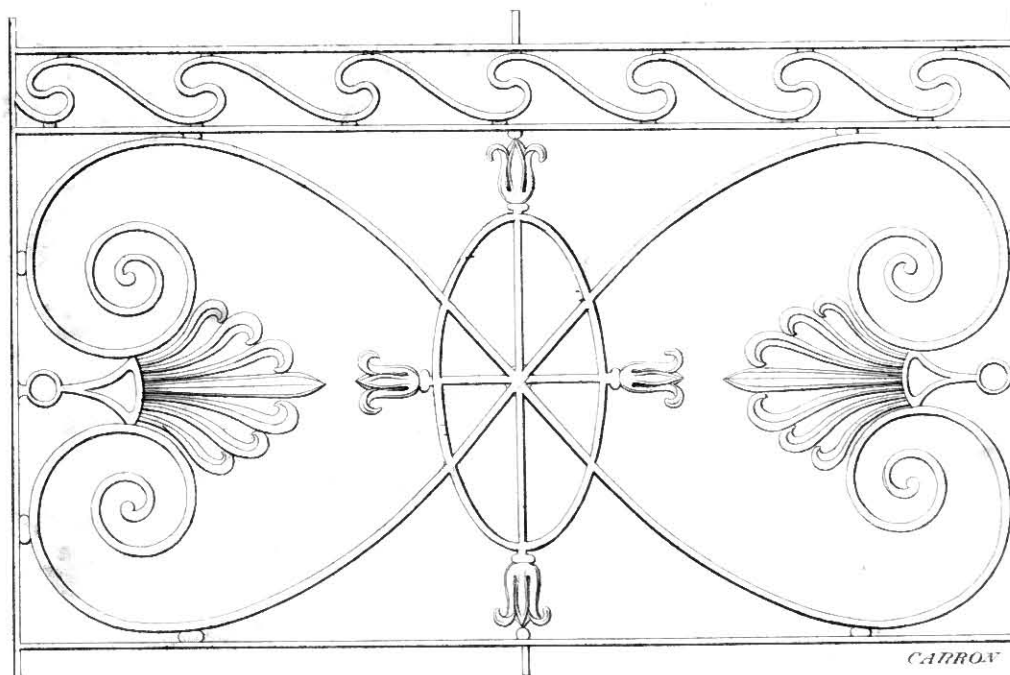
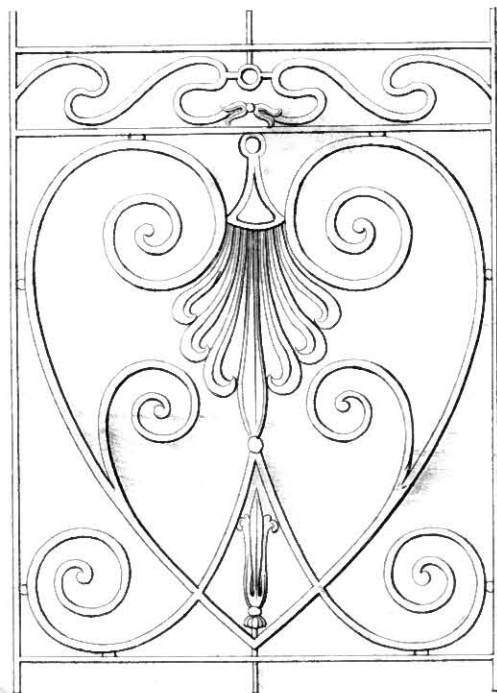

Balcony Pannels

8, 12, 22, &c. 4 1/2 inches wide by 36 inches high.

N^o 3.

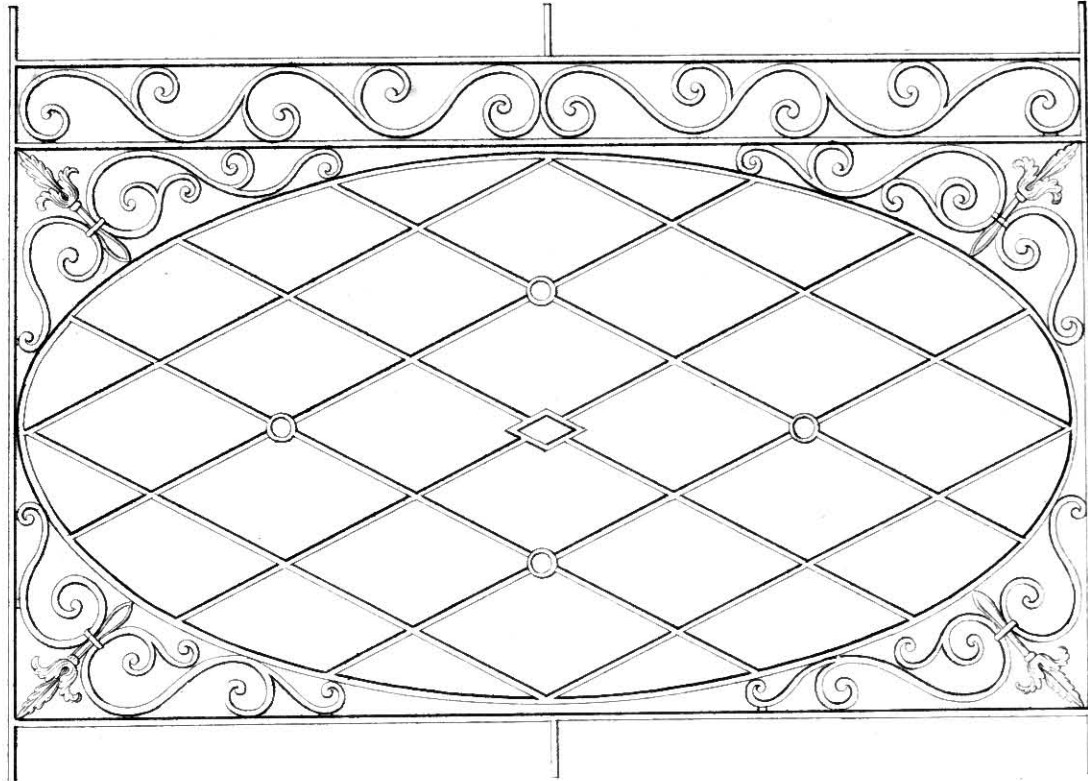
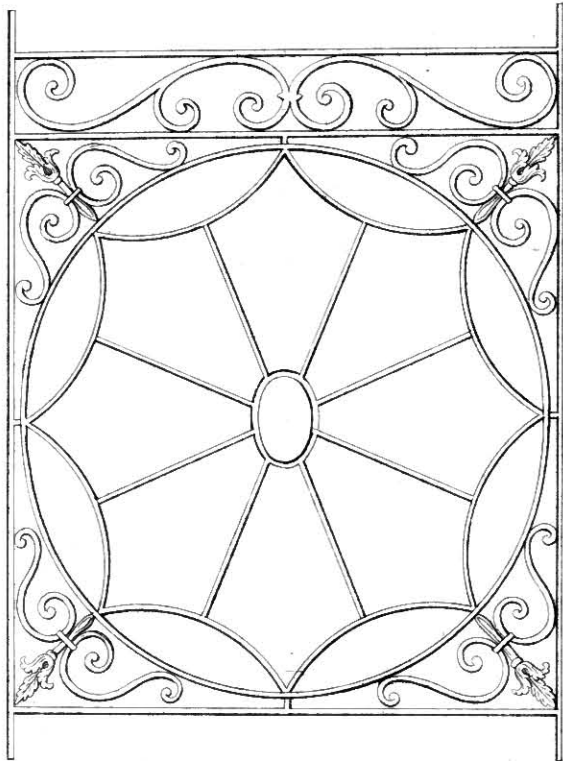

N^o 4.

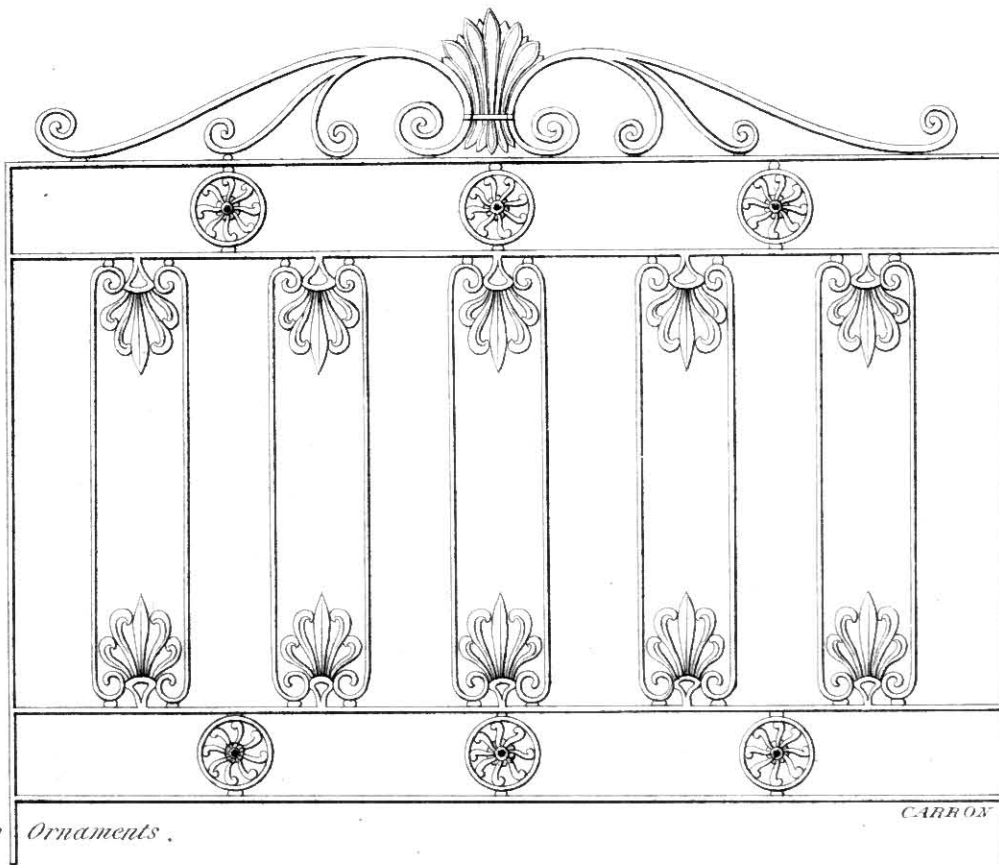
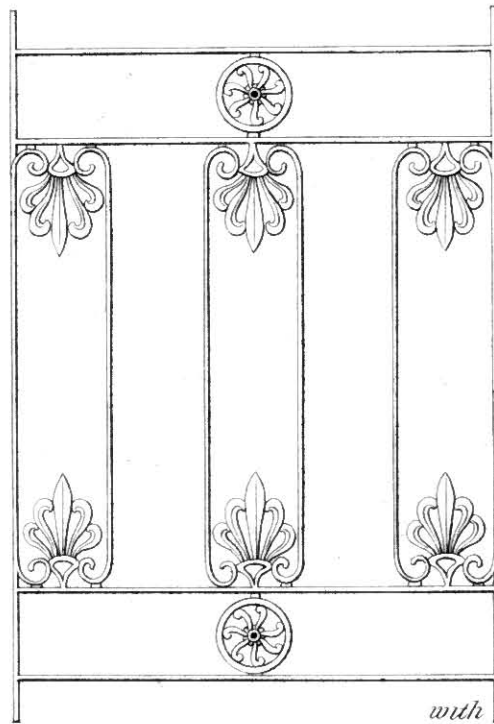

with or without top Ornaments.

CARRON

Balcony Pannels,
8, 12, 22 & 44 1/2 inches wide by 36 inches high.

Sink Traps
4 to 10 inches square
4 9 diameter

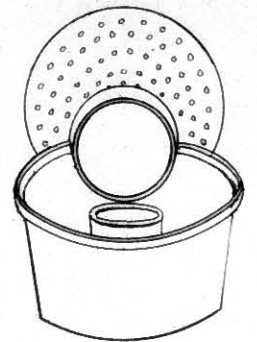
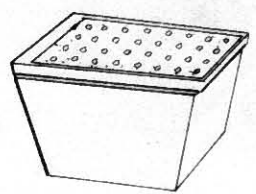

Kilmarnock x Grates.
12, 14, 16, 18, 21, 24 inches wide.

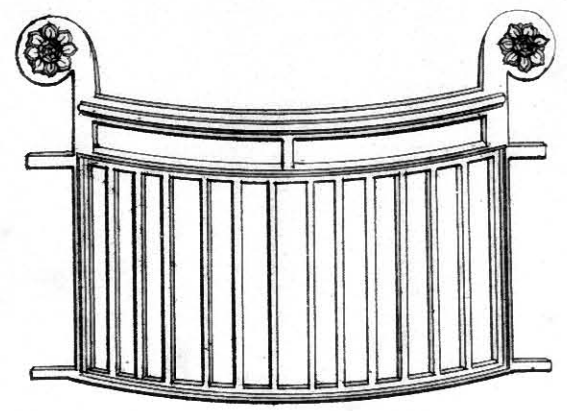

Stirling x Grates and Bottoms.
11 to 24 inches wide

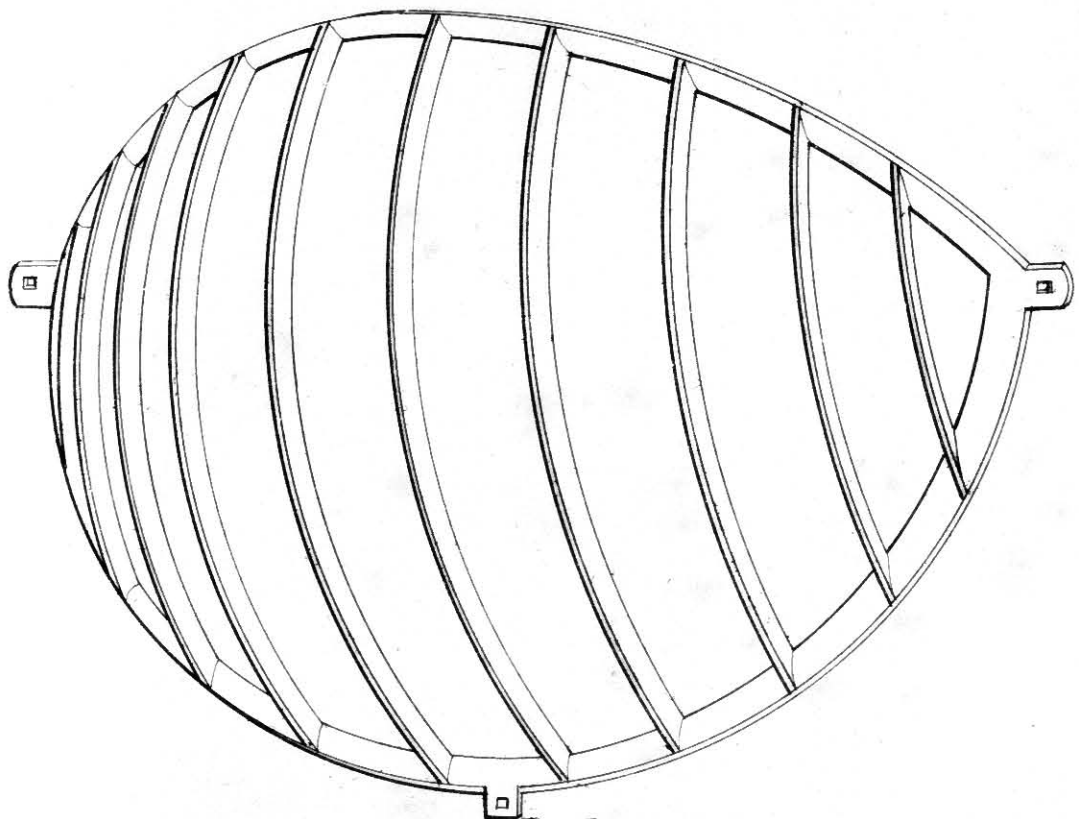
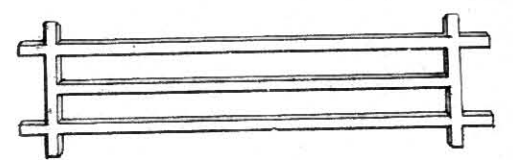
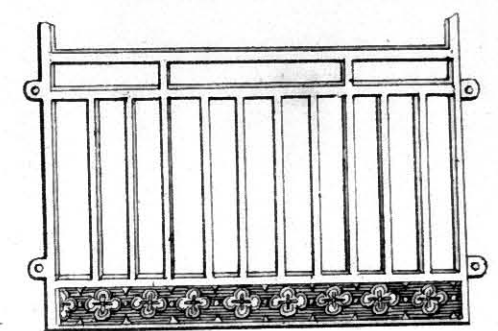

Hay Racks
1. 24 ins. wide, 12 ins. deep, 15 ins. high.
2. 30 " " 12 " " 16 1/2 " "
3. 34 " " 12 1/2 " " 18 " "
and for Corners.

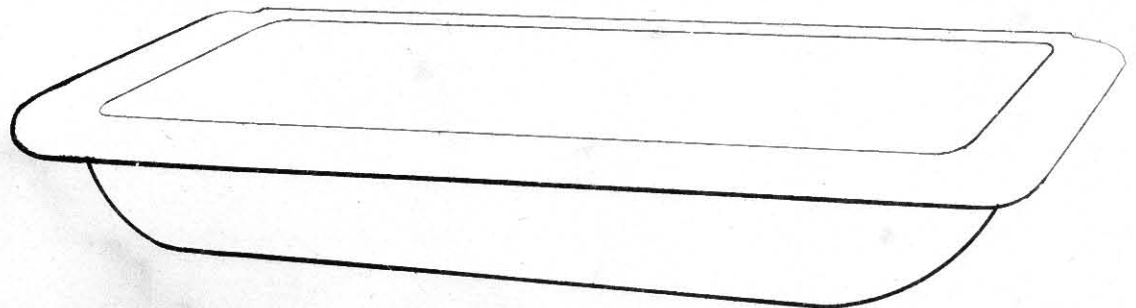

Mangers.
3 feet, 6 feet, & for corners.

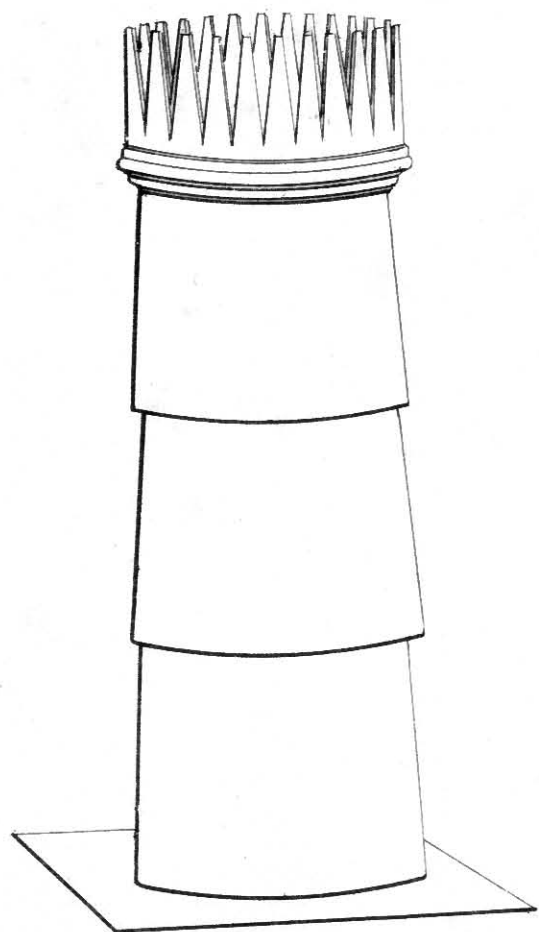

Chimney Cars
1. 33 1/2 ins. high, 10 in diameter at top, 13 1/2 ins. square at bottom.
2. 40 " " " " " " " " " " " "

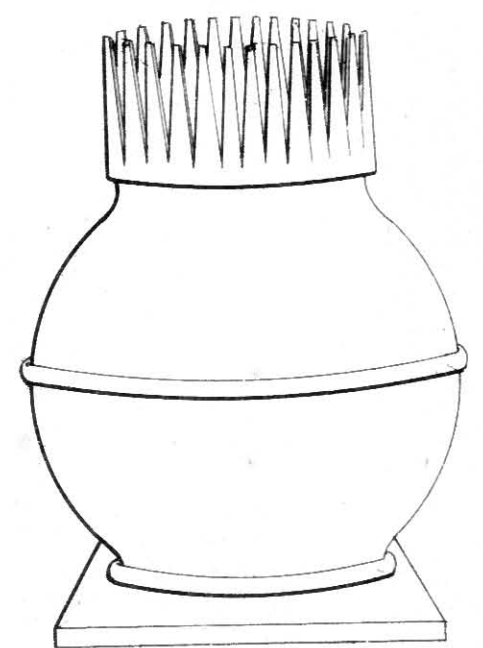

Chimney Car.
27 ins. high, 9 in dia. at top, 14 ins. square at bottom.

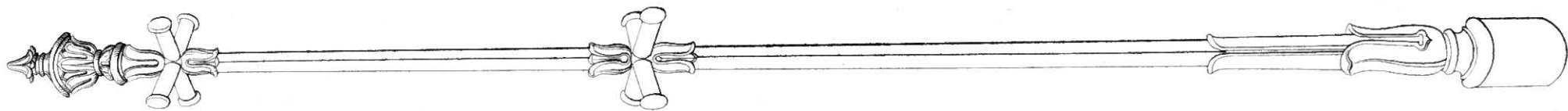

Clothes Post .N.º 2

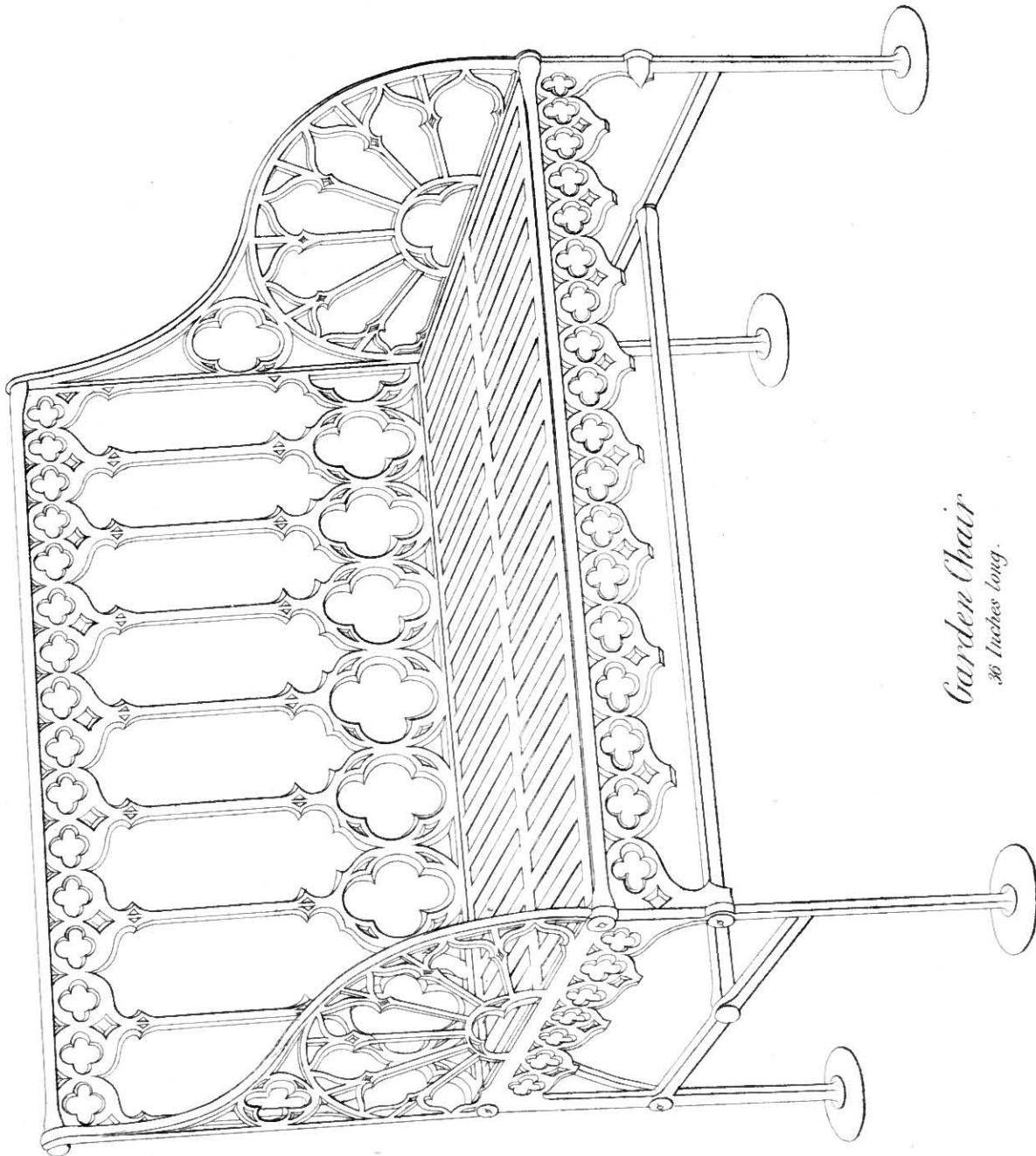

Garden Chair
36 Inches long.

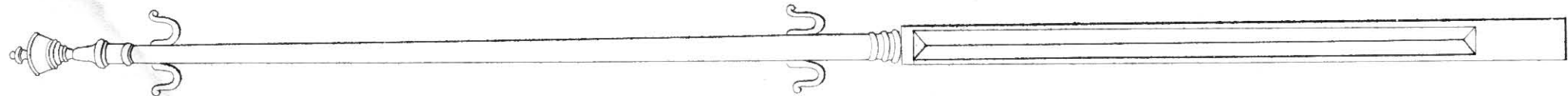

Clothes Post .N.º 1.

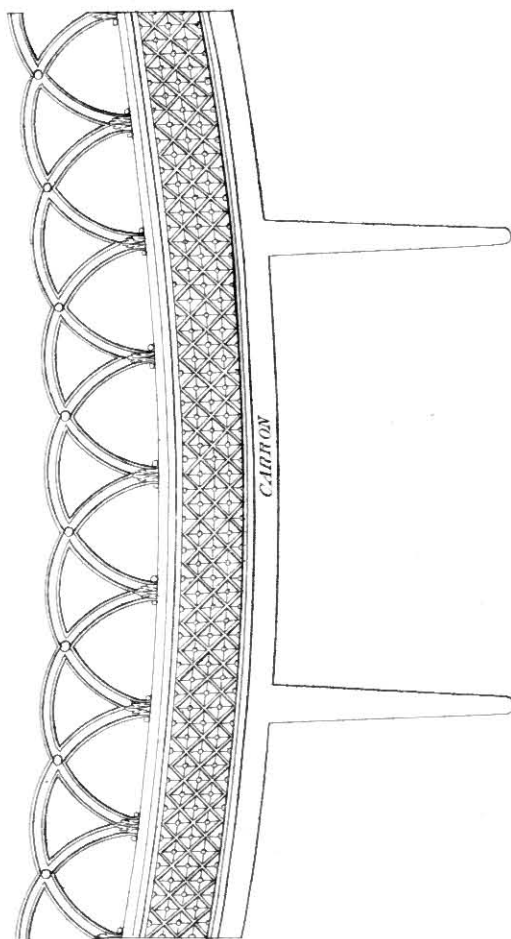

Flower Garden Borders.

10 1/2 & 36 Inches long, Straight.
18 & 20 Inches long, convex & concave.

Machine & Macdonald Ltd.
Glasgow.

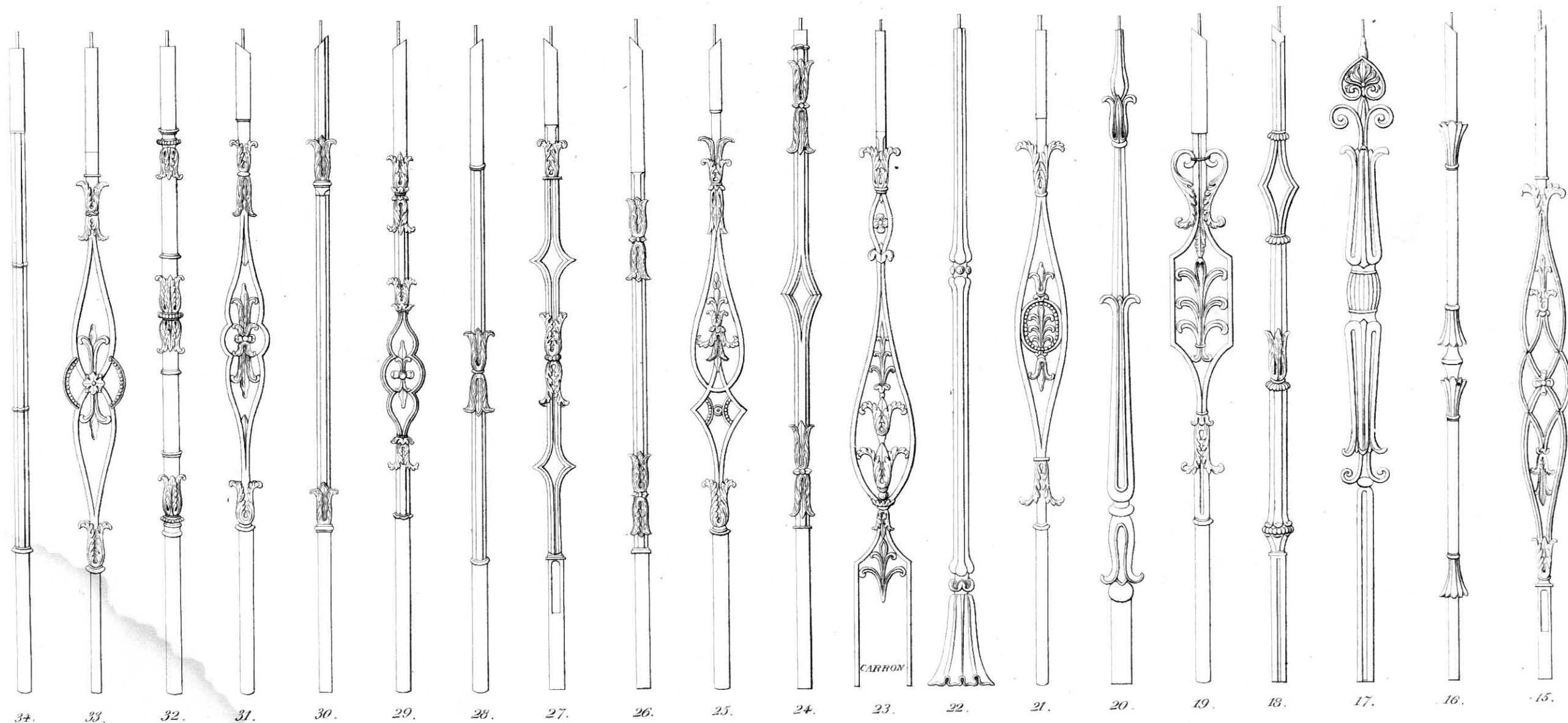
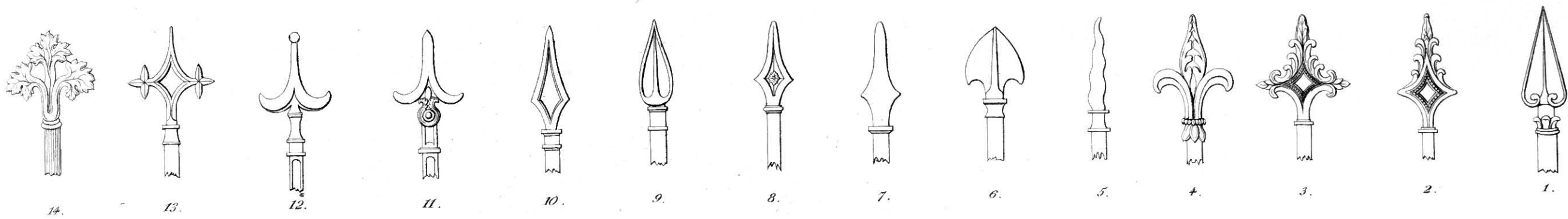

Ballusters.

Maclure & Macdonald Lith^{rs}
Glasgow.



6

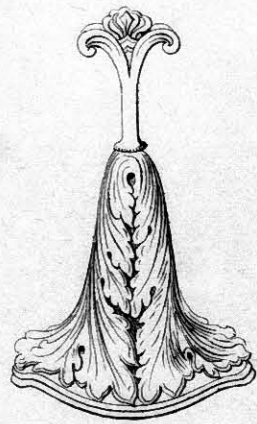

3

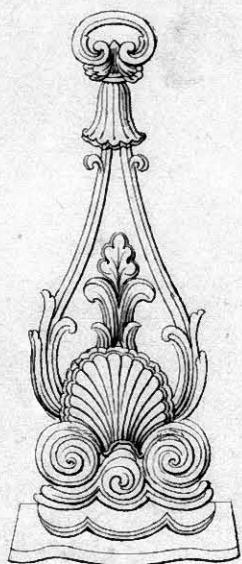

5

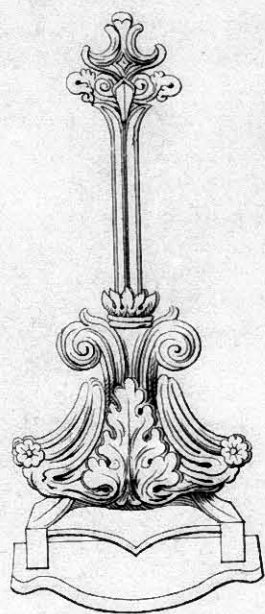

4



5



6



7



1

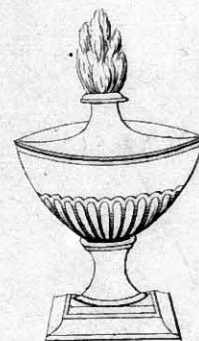

2



3

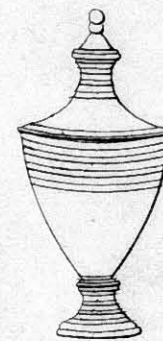

4

Door Porters.

Vases for Ballusters.

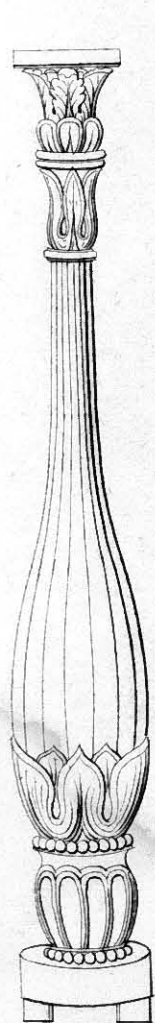

35

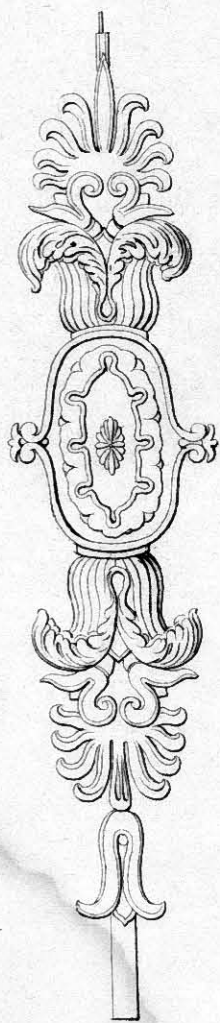

36

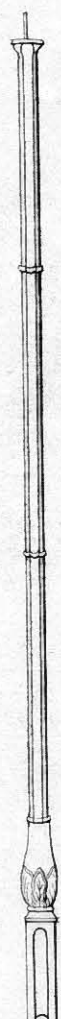

37

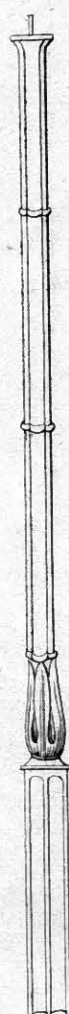

38

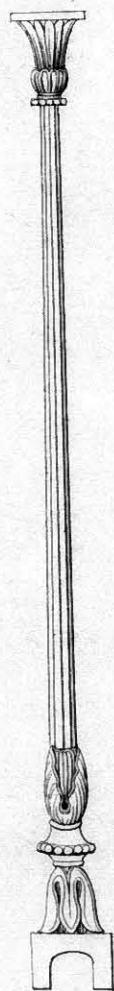

39

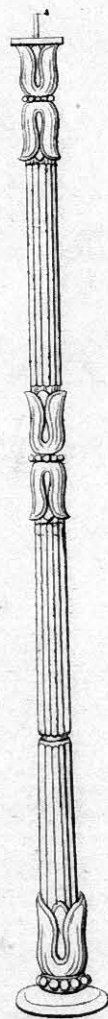

40

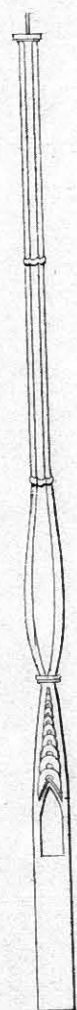

41

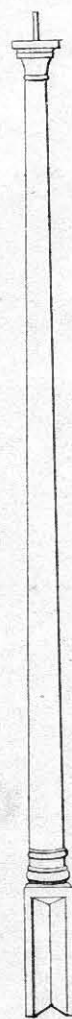

42



43



44

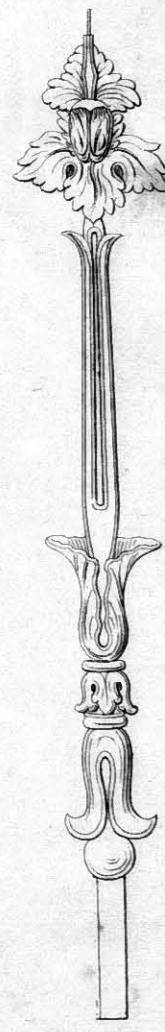

45

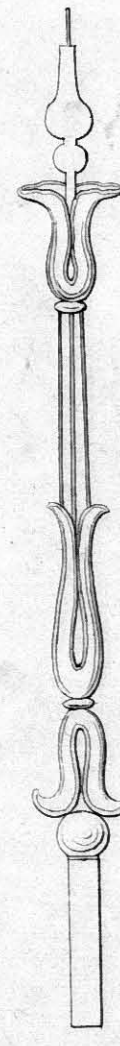

46

Ballusters.

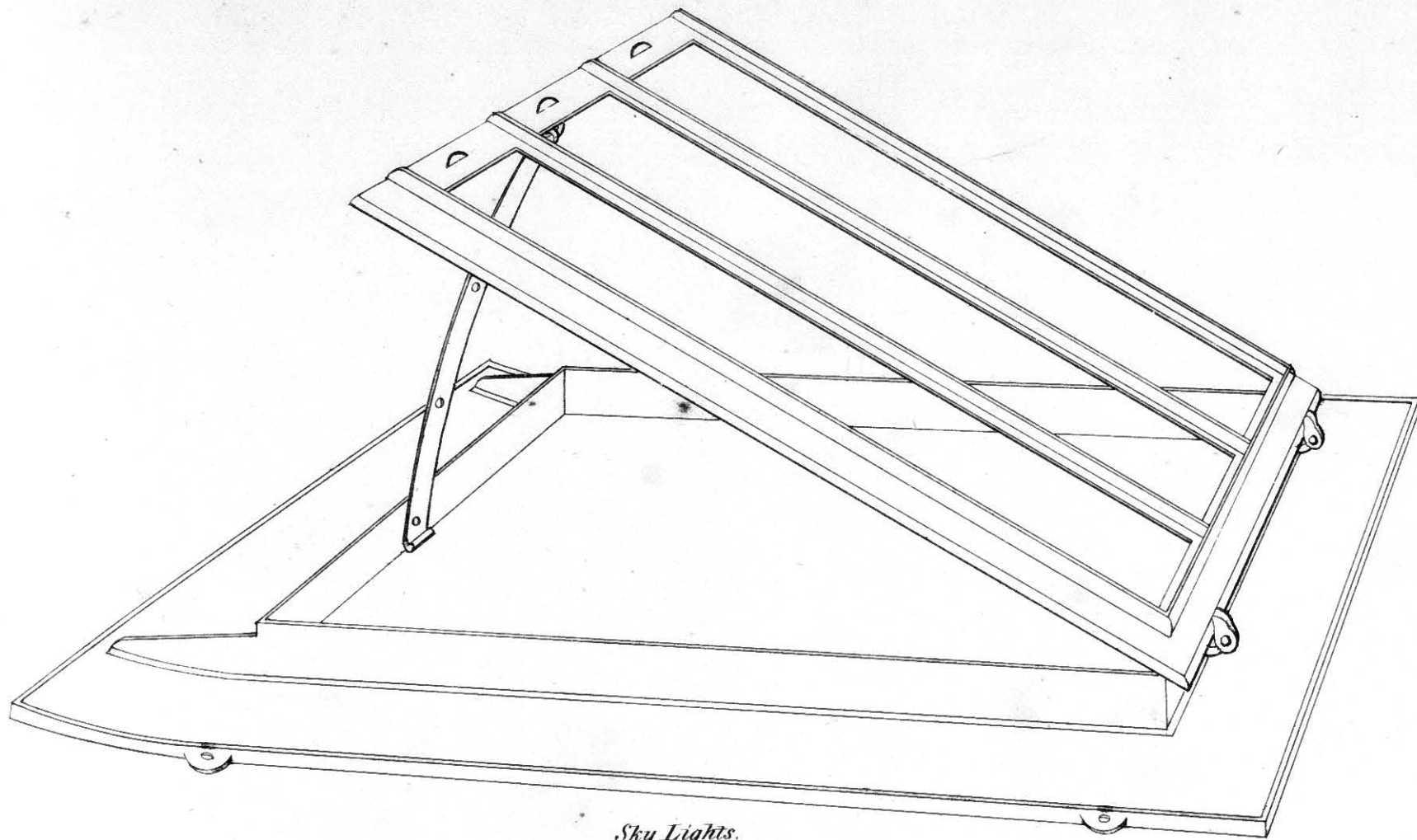

Sky Lights.

Size of Daylight 8 x 11½ 12 x 14 15½ x 29½ 16½ x 29½ 20 x 36 inches
 Size of Outside 12½ x 21½ 17 x 24½ 20 x 40 25 x 41 30 x 48 inches
 Light only without Frame 15 x 28 inches. daylight. 19½ x 34 outside.

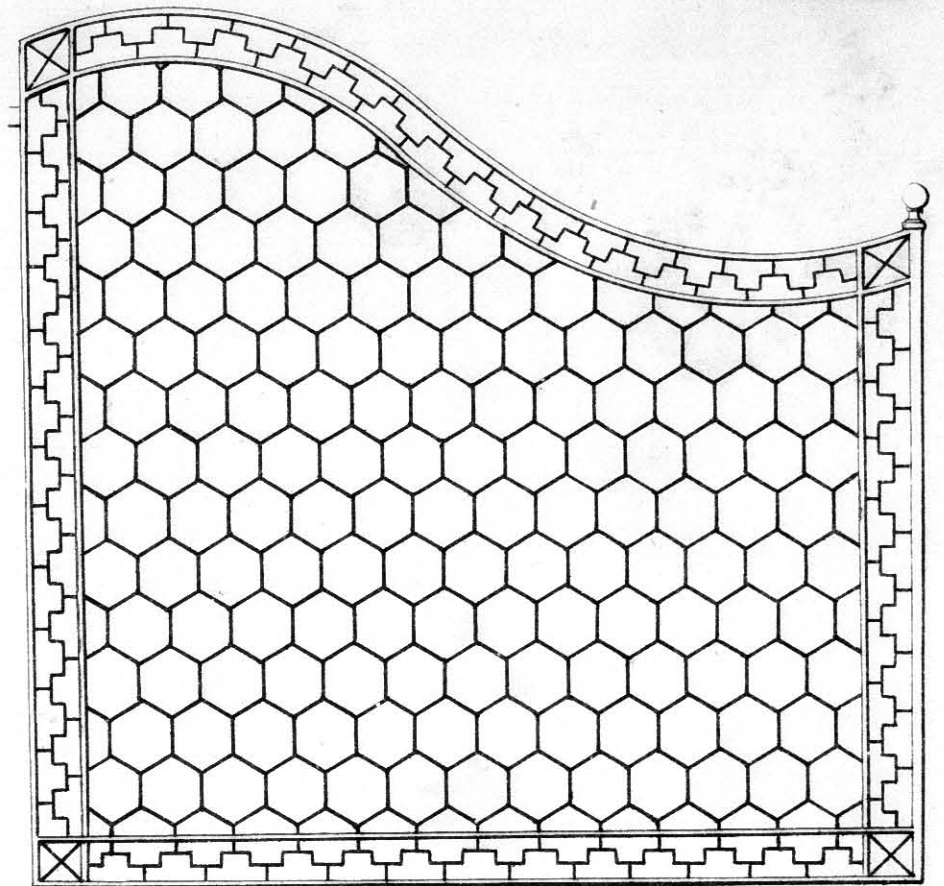

Counter Rail

27 inches long by 24 inches wide.

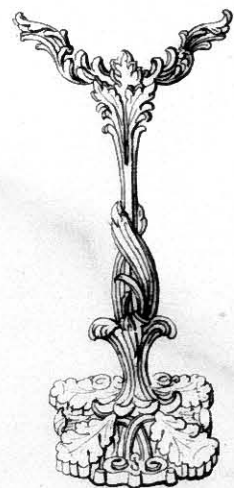

7



2



4



5

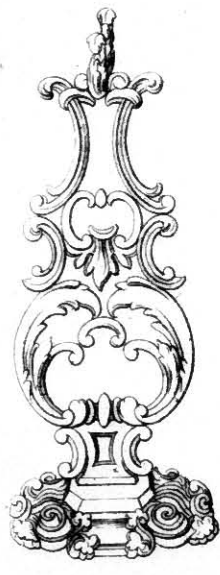

5 Crossed.

Fender Stands.

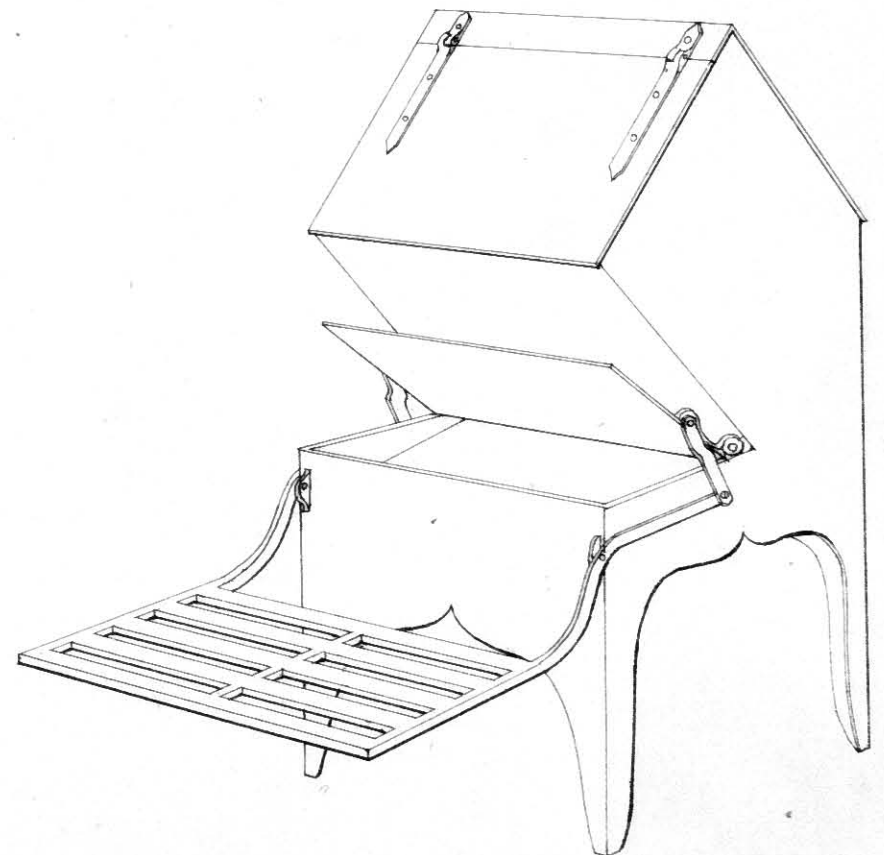

Pheasant Feeder.

Pig Troughs without divisions Sizes 24, 27, 30, 33, 36, 42, 48, inches.
 D^o with divisions Sizes 24, 27, 30, 33, 36, 42, 48, 54, 66 inches.

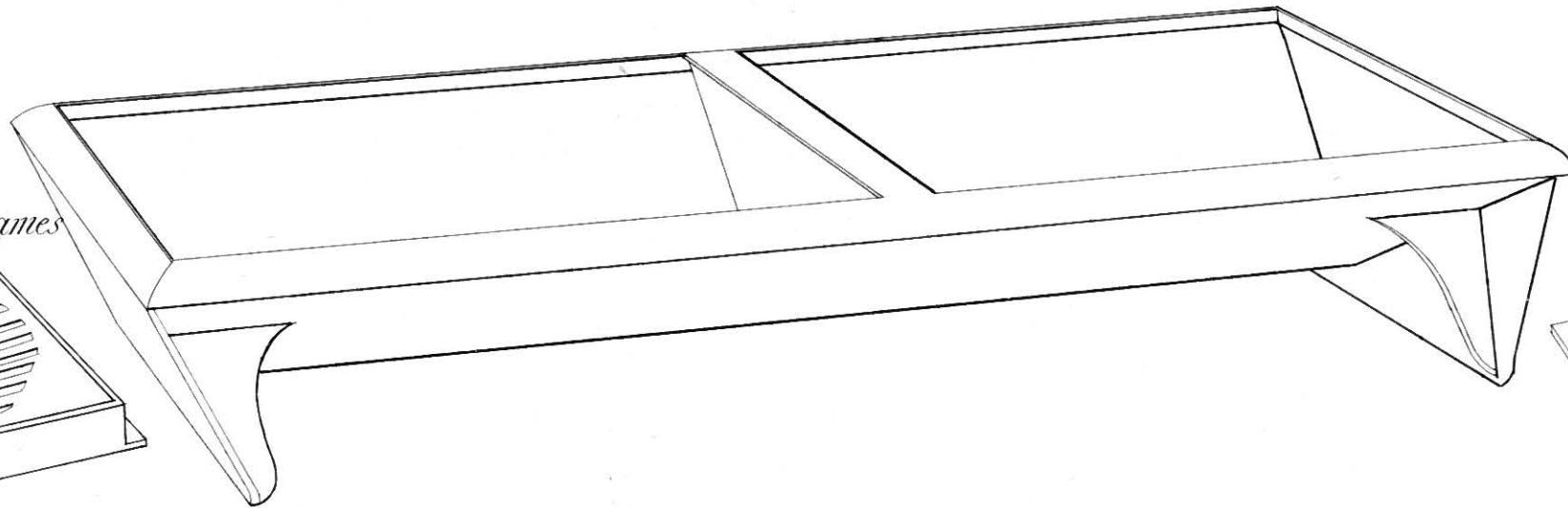

Stable drain Grates & frames

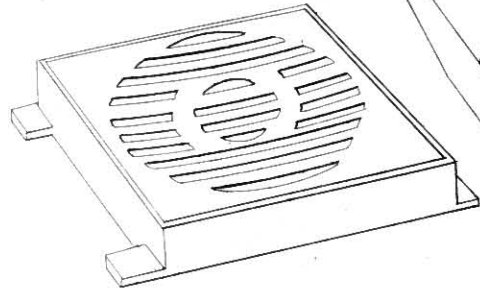

Sizes 10, 12, 15, 18, inches

Drain Grates & Frames.
 Sizes 4, 6, 8, 10, 12 inches.

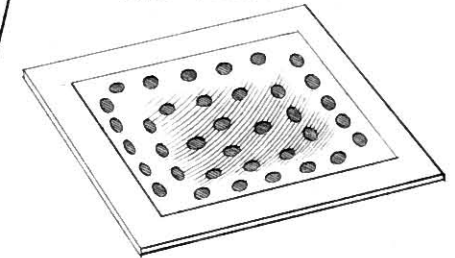

Pheasant Troughs.

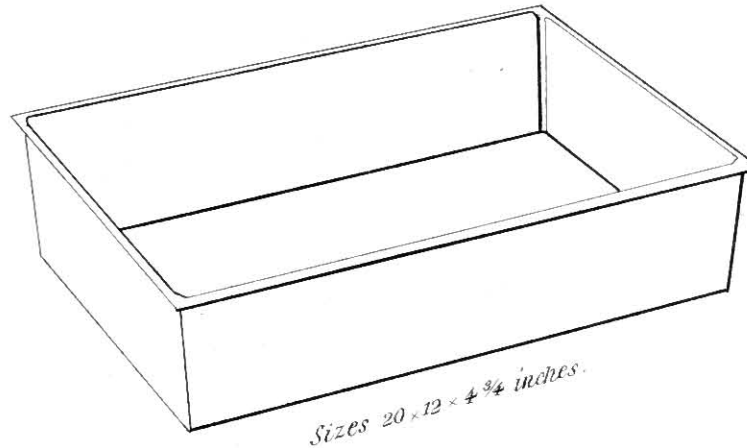

Sizes 20 x 12 x 4 3/4 inches.

Poultry Troughs, Sizes 24, 36, 48 inches

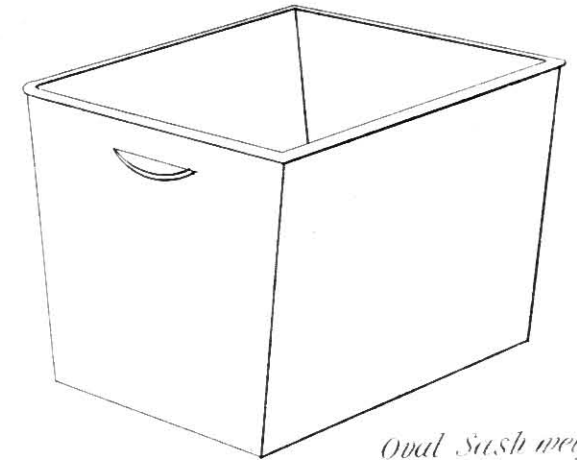
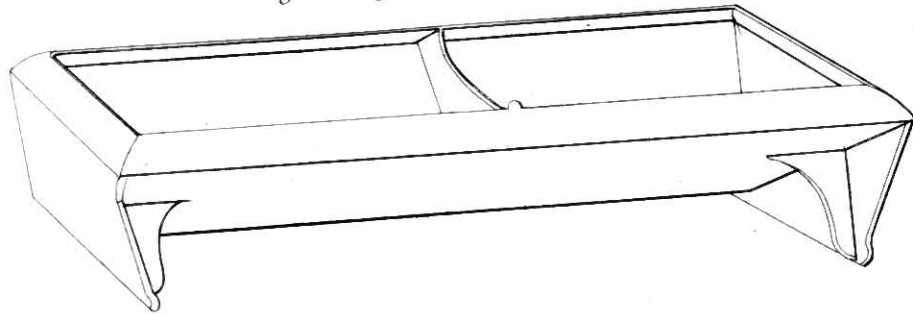

Oval Sash weight

Dog Troughs
 Nos. 1 2.
 9 1/2, 12, 18, ins. long
 7 1/4, 9, 9, ins. Broad
 6 1/2, 8, 8, ins. deep.

Round Sash weight



Sizes 3 to 11 lbs. each.

Square Stewing Stoves & Grates.

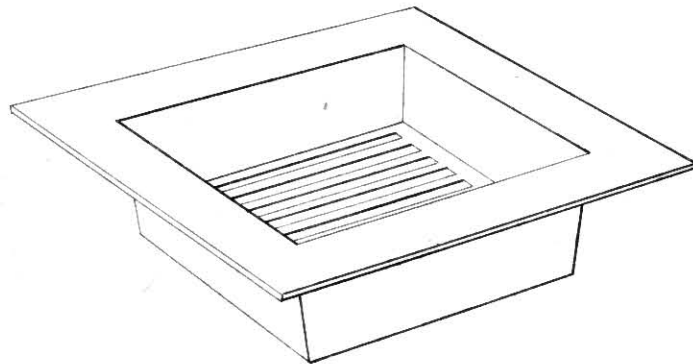

Sizes 6, 7, 8, 9, 10, 11, 12 inches.

Oval Stewing Stoves & Grates.

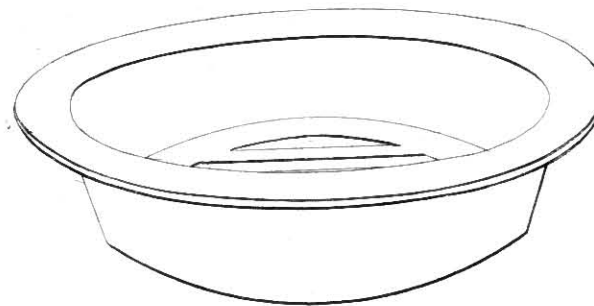

Sizes 12, 13, 14, 15, 16, 17, 18 inches long inside.

Round Stewing Stoves & Grates

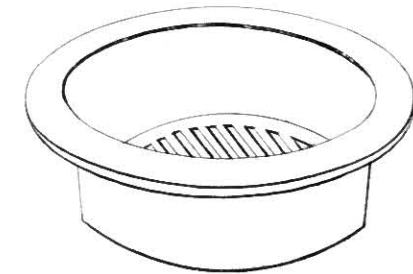

Sizes 6, 7, 8, 9, 10, 11, 12, inches.



Sizes 11 1/2 to 16 lbs each.

Ornaments.

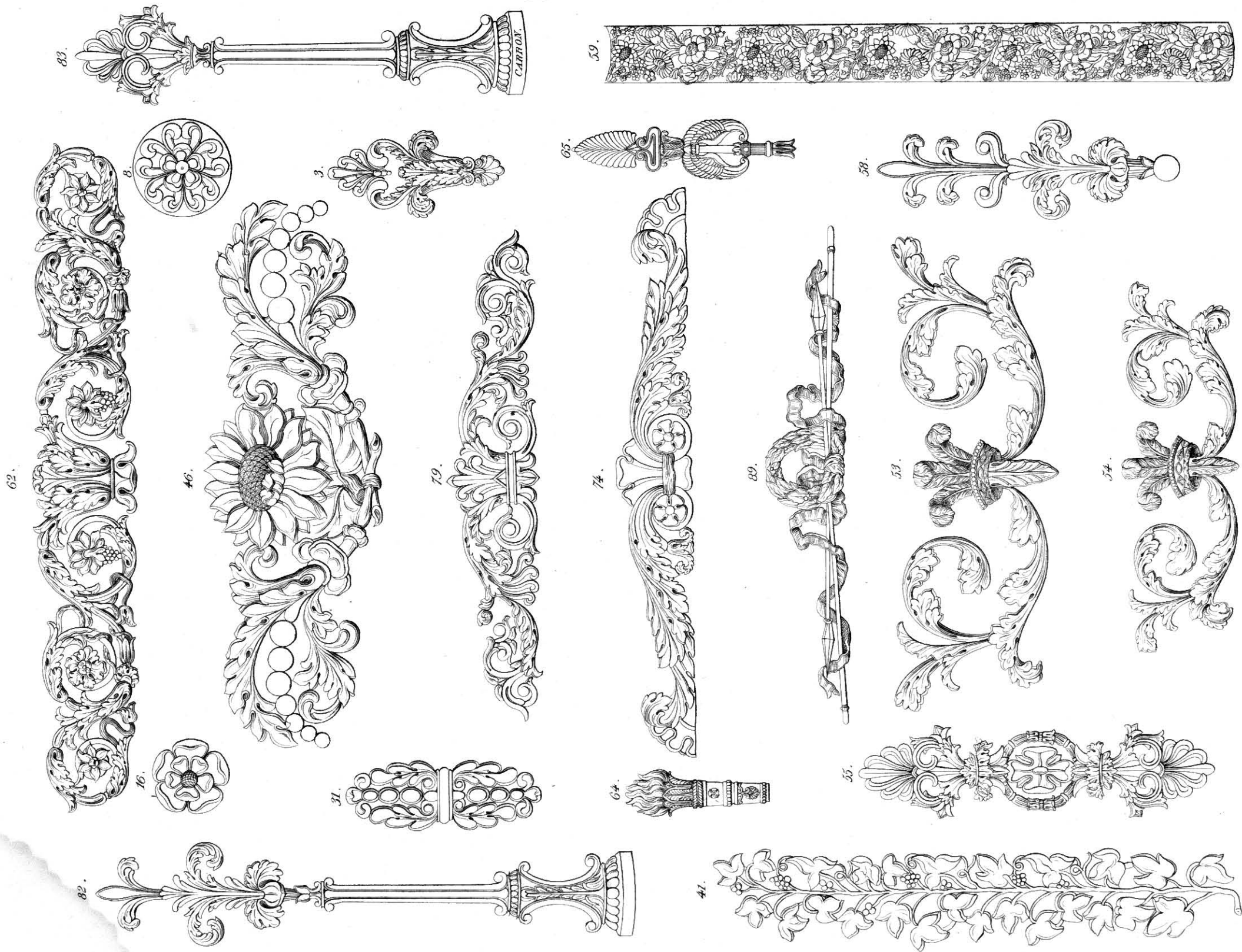

Ornaments.

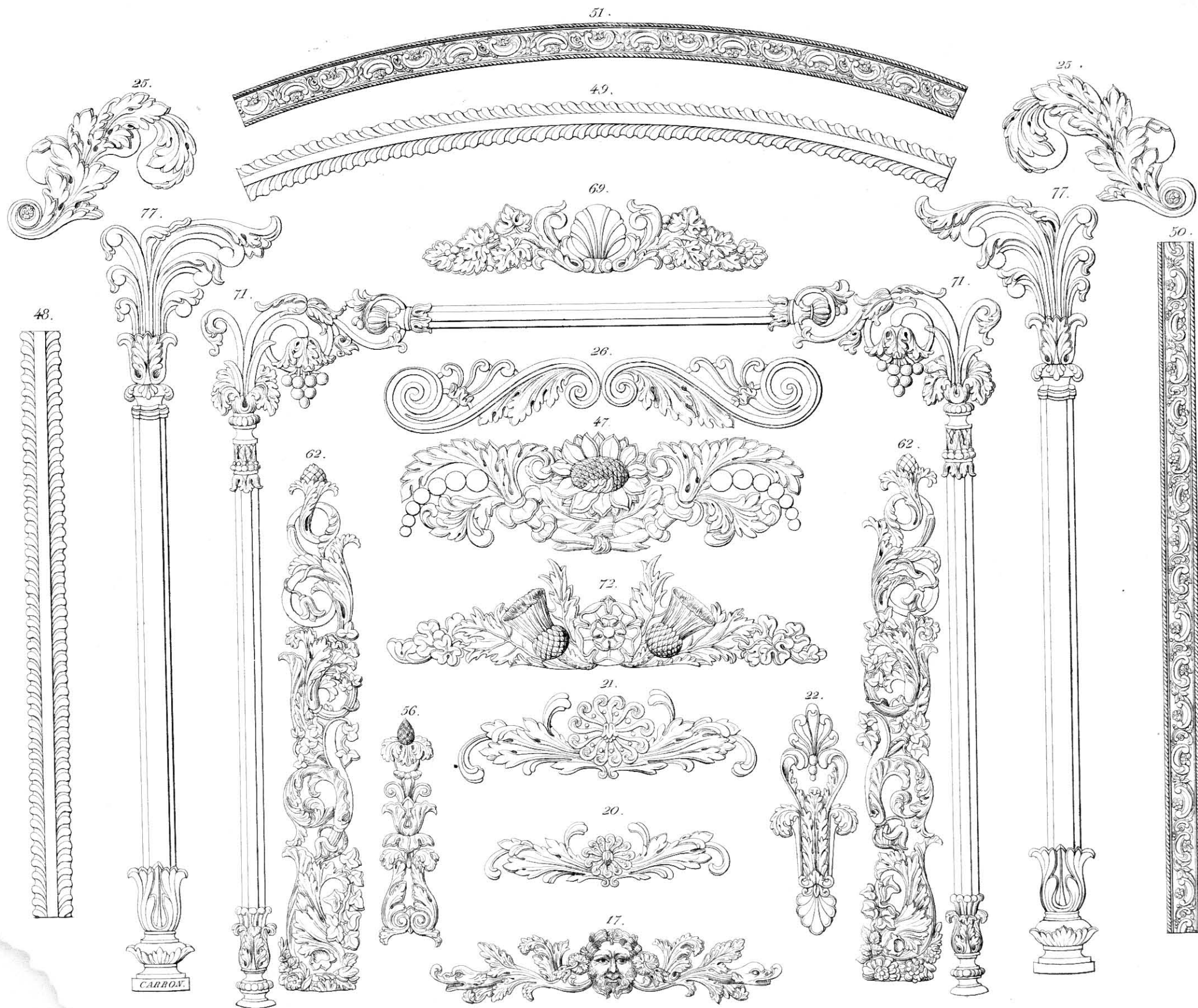

Ornaments.

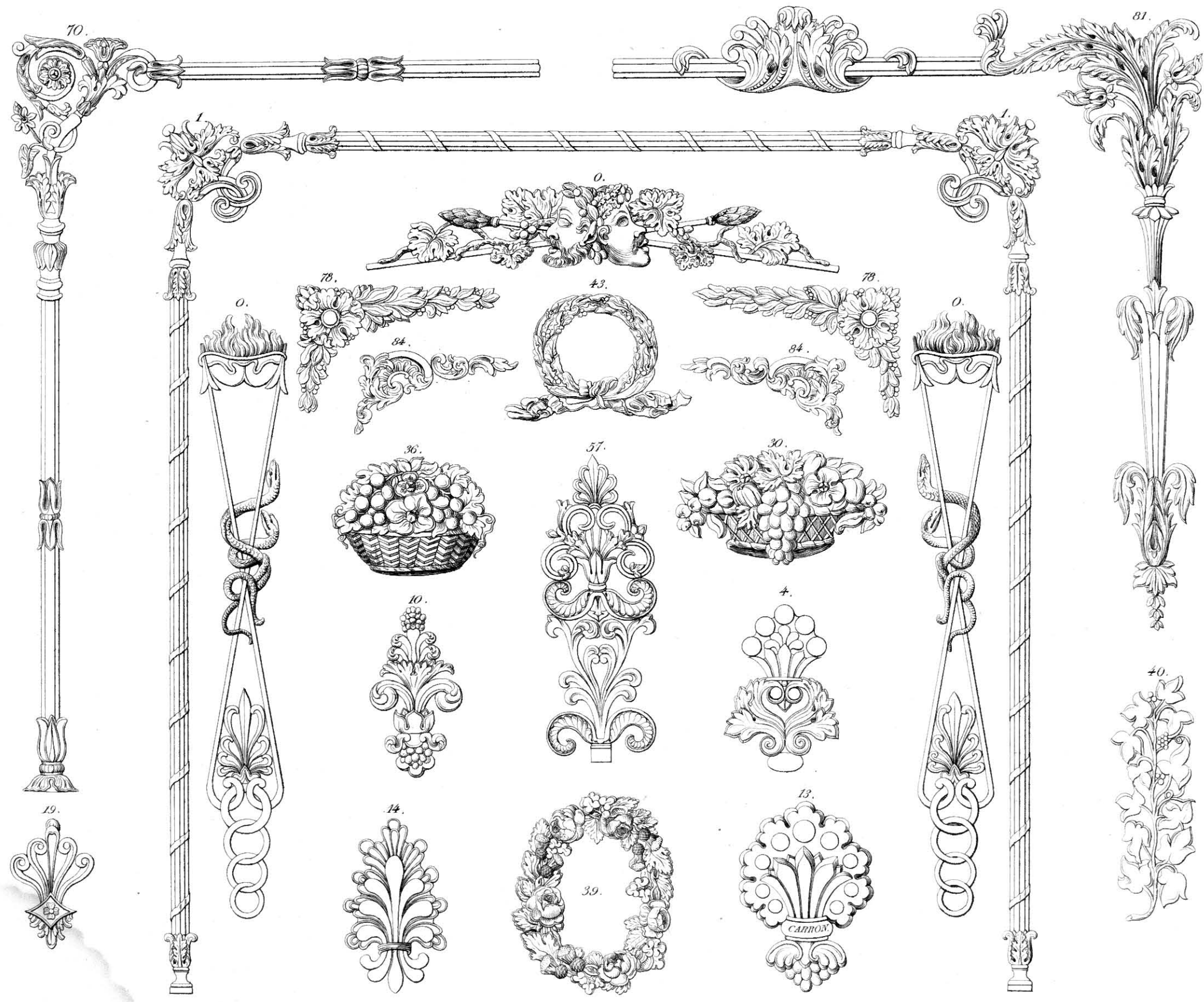

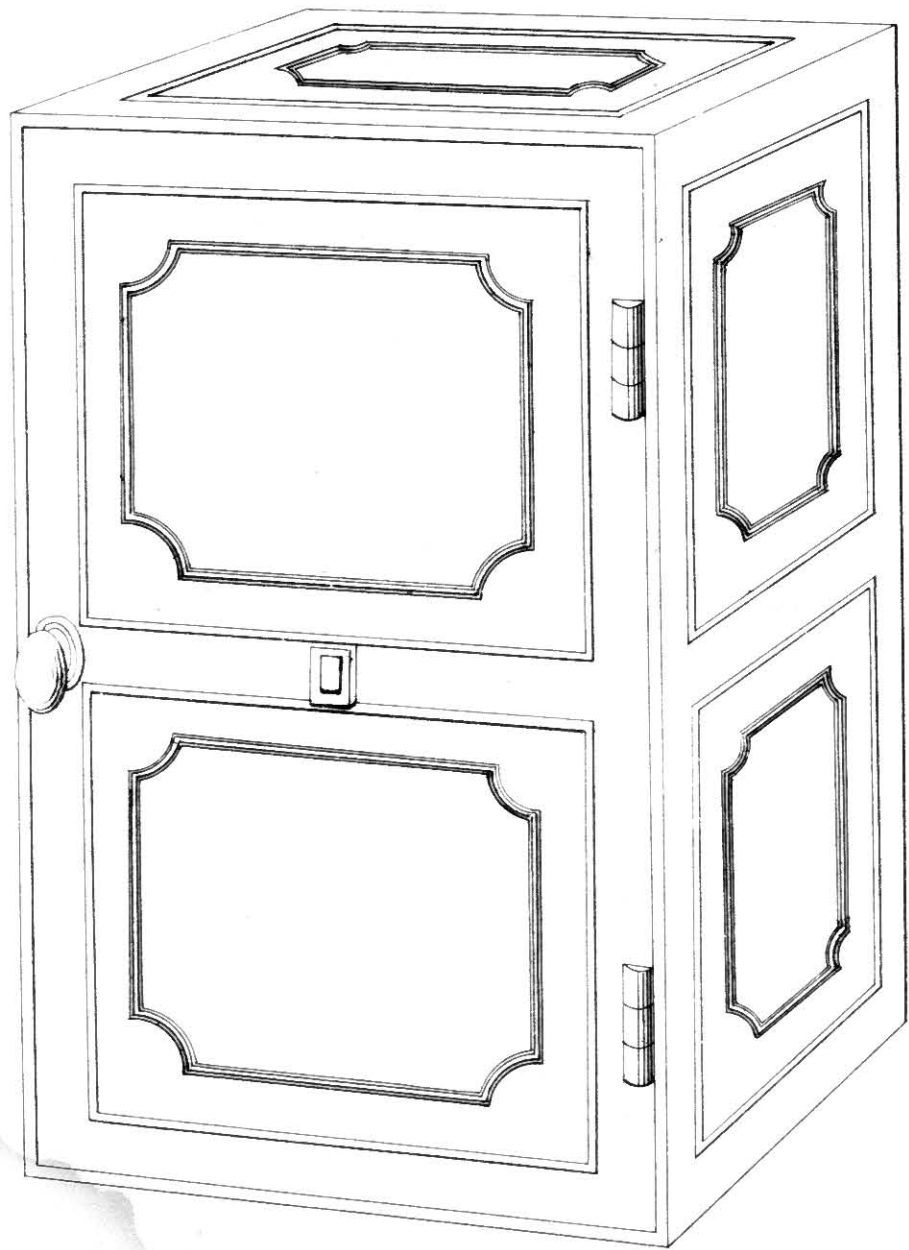

Money Chest or Book Case with single door & with or without drawers.

Sizes 15. 18. 21. 24. 28. 32. 36 Ins. High or long Outside.

The Money Chests have handles at the ends.

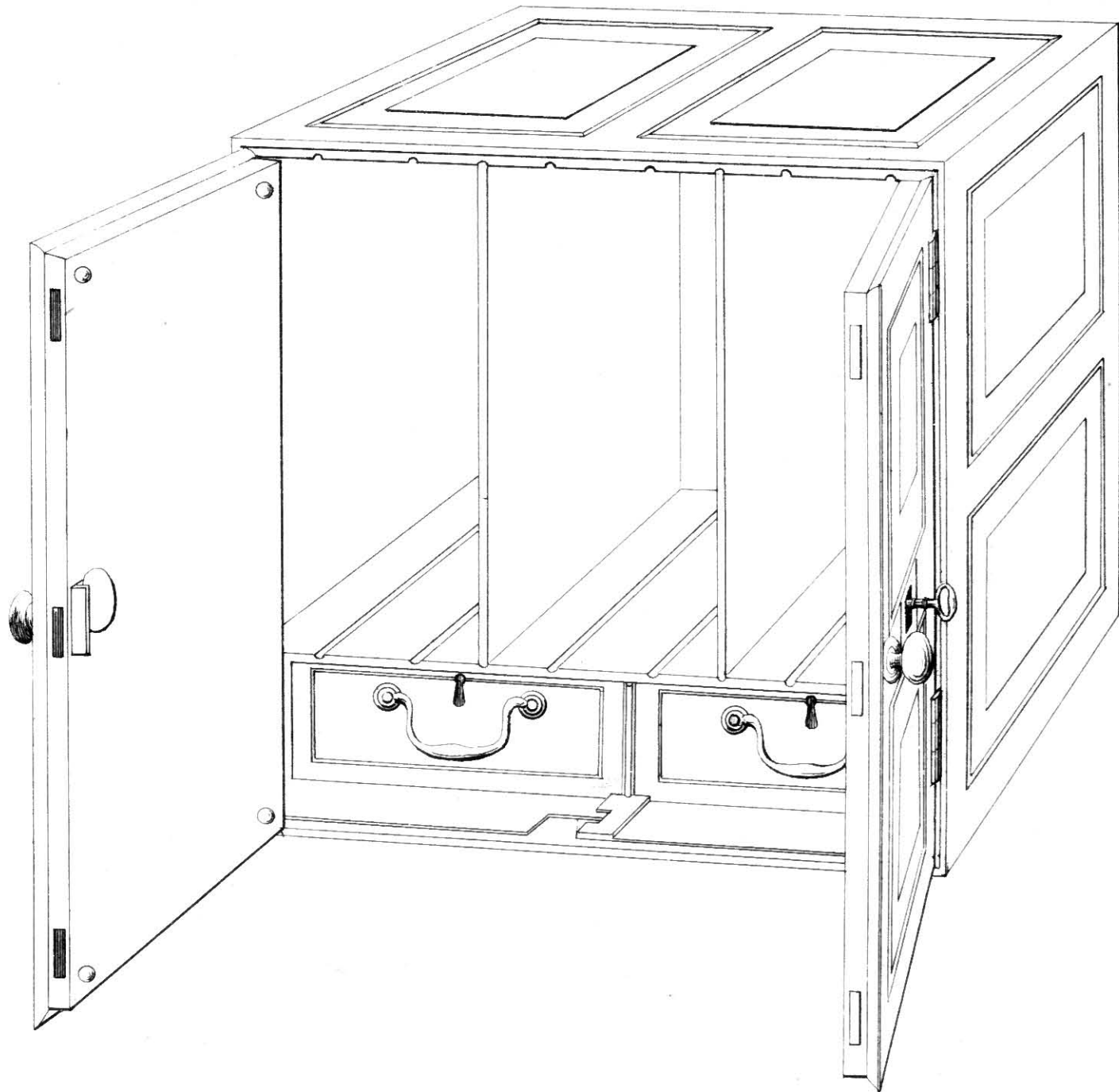

Book Case with double doors, drawers & sliding partitions.

Sizes 24. 27. 30. 33. 36 inches square.

Stack Pillar.

16 inches high.

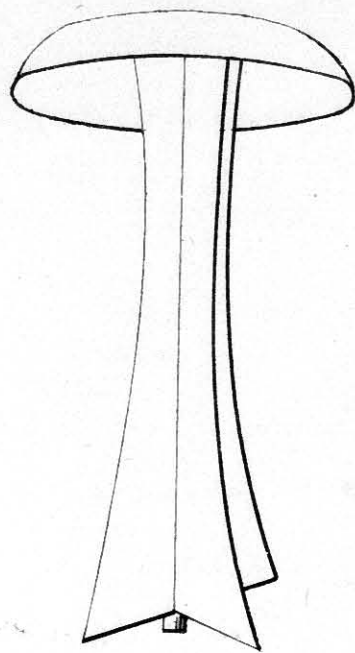

Coal Hole Plate.

18 inches diameter inside.

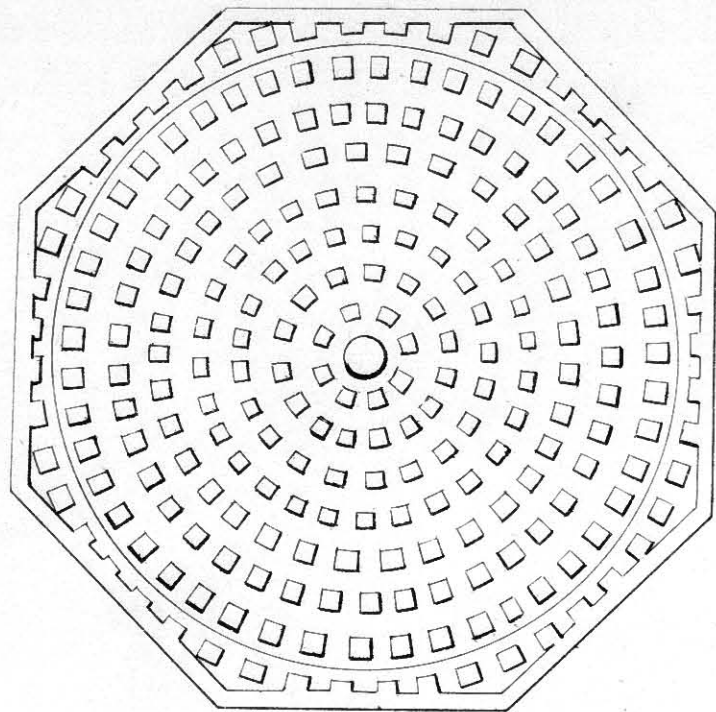

Coal Hole Plate.

18 inches square inside.

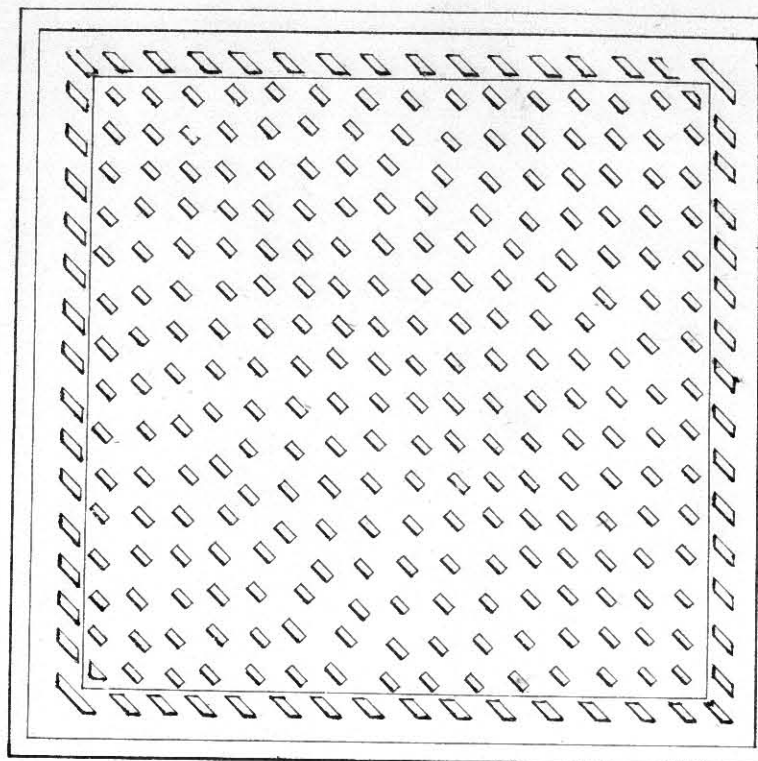

Stack Pillar.

22 & 26 inches high.

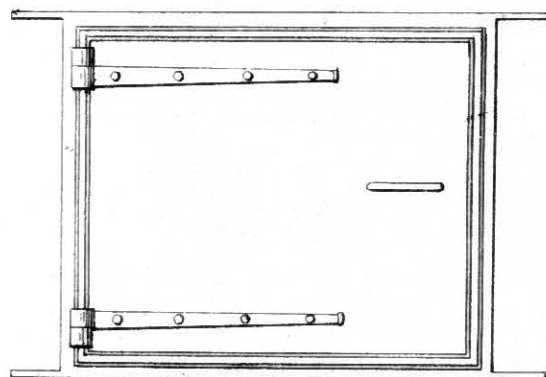
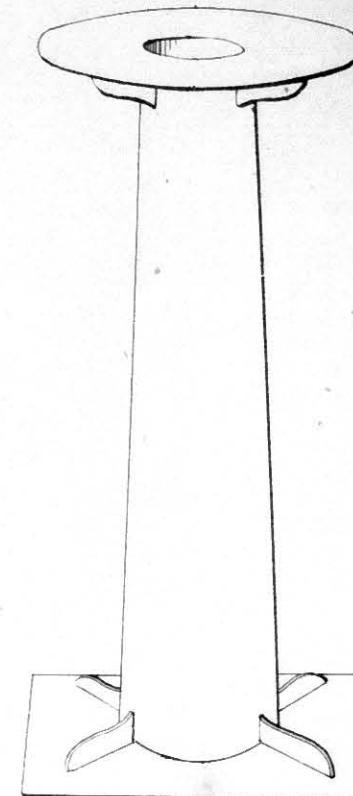

Furnace Door.

Sizes 8, 9, 10, 11, 12, 13 inches wide inside.

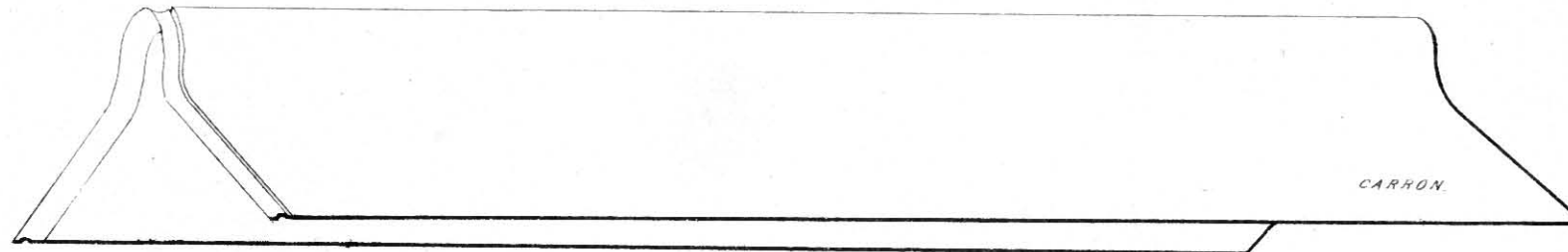

Ridge for Houses.

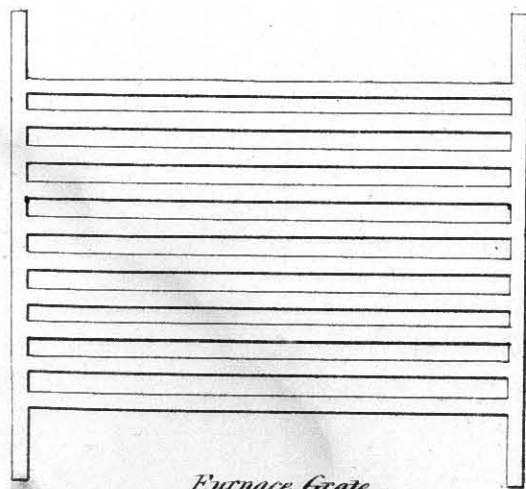

Furnace Grate

to suit the Furnace Doors.

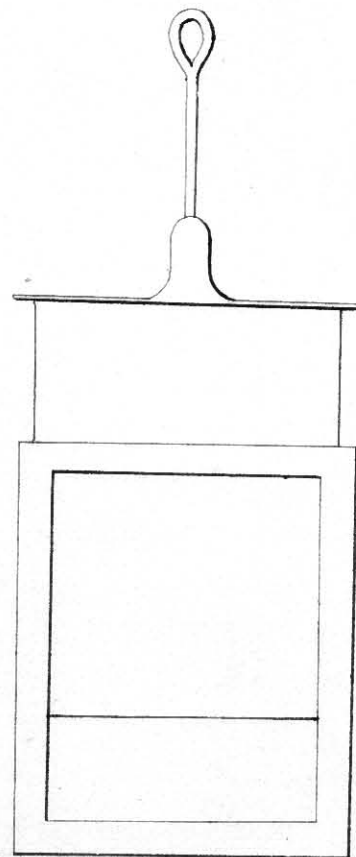

Damper

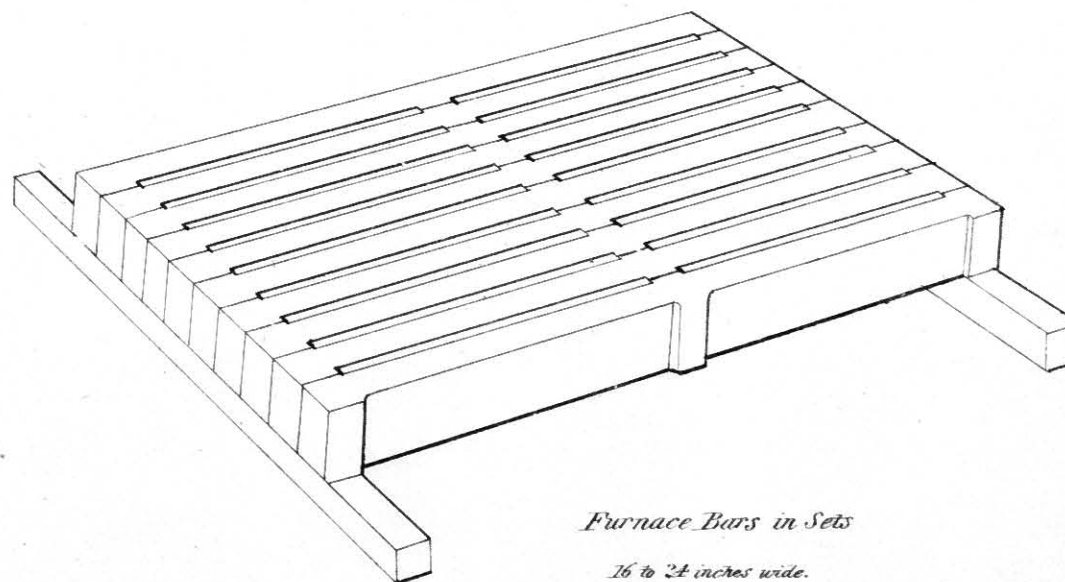

Furnace Bars in Sets

16 to 24 inches wide.

Ice Iron
No. 1, 2, 3, 4, 5, 6, 7, 8, 9.

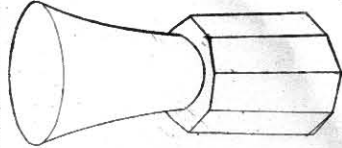

Oval Sad Iron
No. 0, 1, 2, 3, 4, 5, 6.

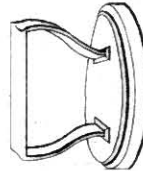

Dumb Bells
4 to 22 lb pair.

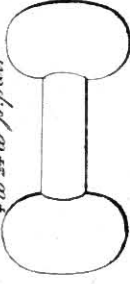

Sad Iron Stand
No. 1, 2, 3.



Tailors Iron
No. 1, 2, 3, 4, 5, 6, 7, 8, 9.

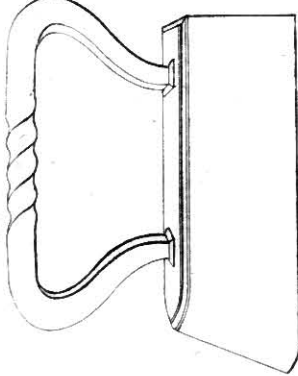

Sad Iron with sharp or round point.

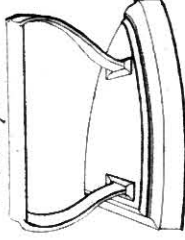

Box Iron heater
No. 1, 2, 3, 4, 5, 6, 7, 8.



Barrow Wheel
12, 14, 16, 18 inches.

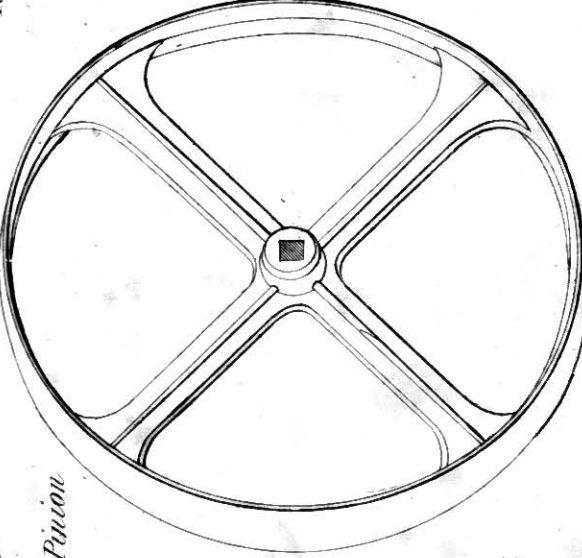

Fanner Wheel & Pinion
12 in Diam.

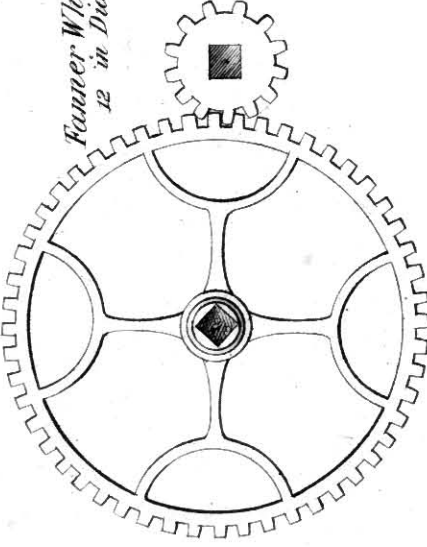

Fanner Wheel & Pinion
10 in Diam.

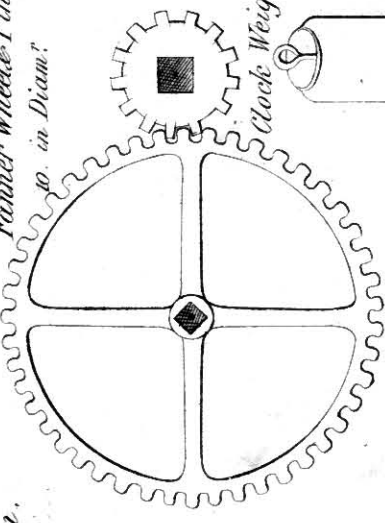

Clock Weight.

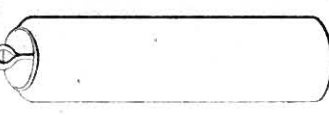

Cast Iron Cart Mave
Sizes 11 1/2 x 2 1/4 x 1 1/4.

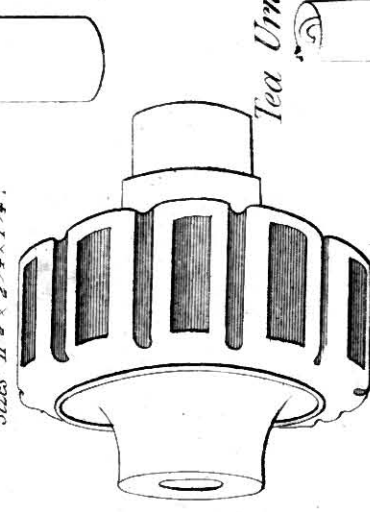

4 1/2 x 3
4 1/2 x 2 1/2

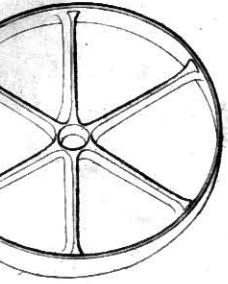
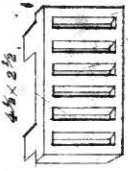
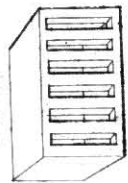

Truck Wheel
4 to 12 in.

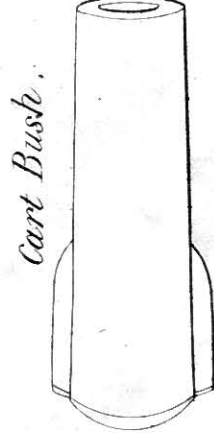

Cart Bush.

Tea Urn Heater



Air Bricks.

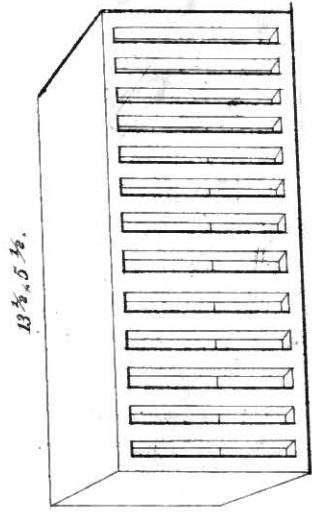

Cast Iron Sweeps
20 to 30 inches

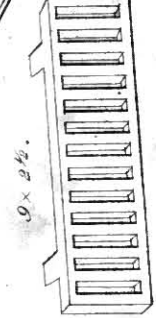
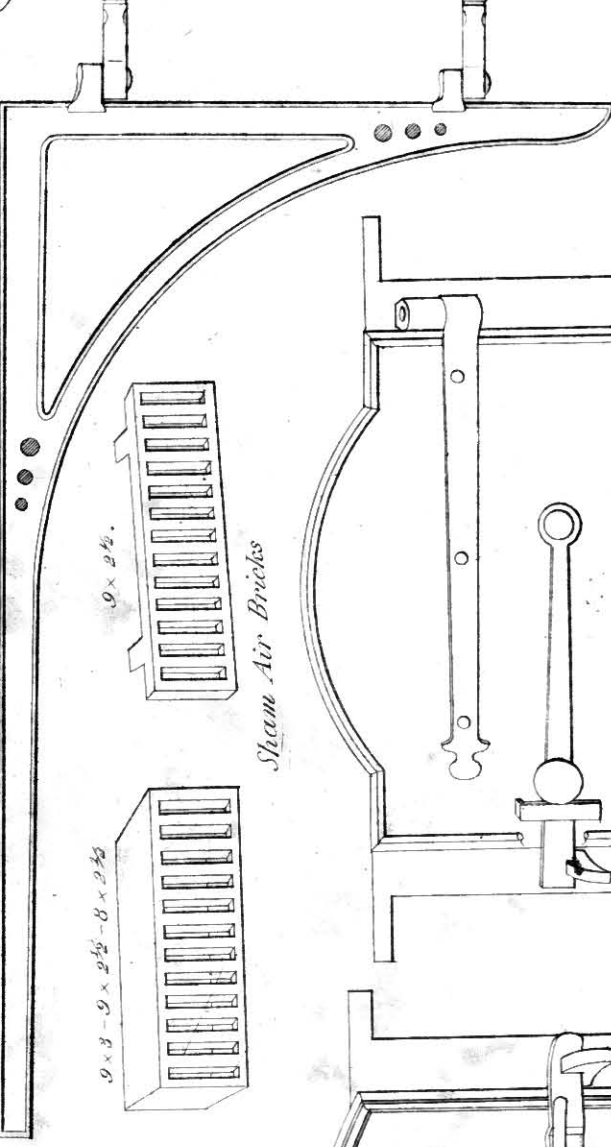

Steam Air Bricks

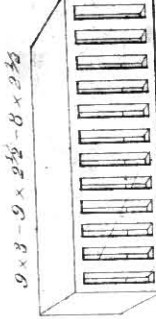

9 x 3 - 9 x 2 1/2 - 8 x 2 1/2

Bakers Door with wrought Iron hinges right or left.
Sizes 15 to 22 inches.

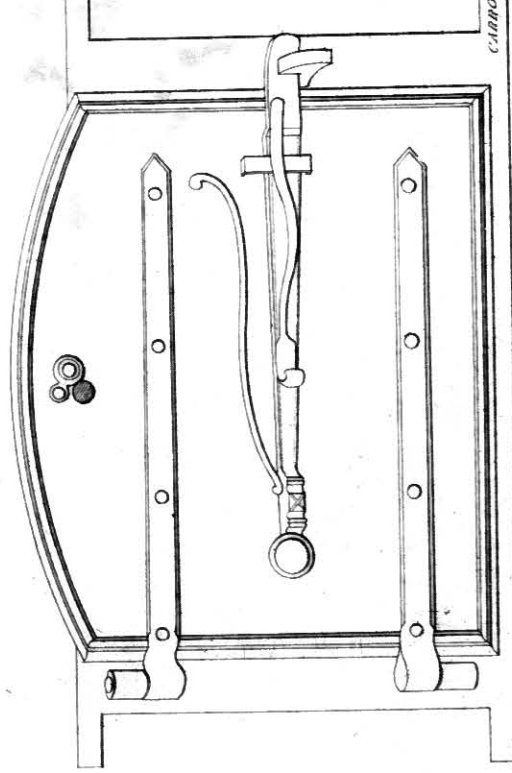

Bakers Door with Cast hinges right or left.
Sizes 14 to 22 inches.

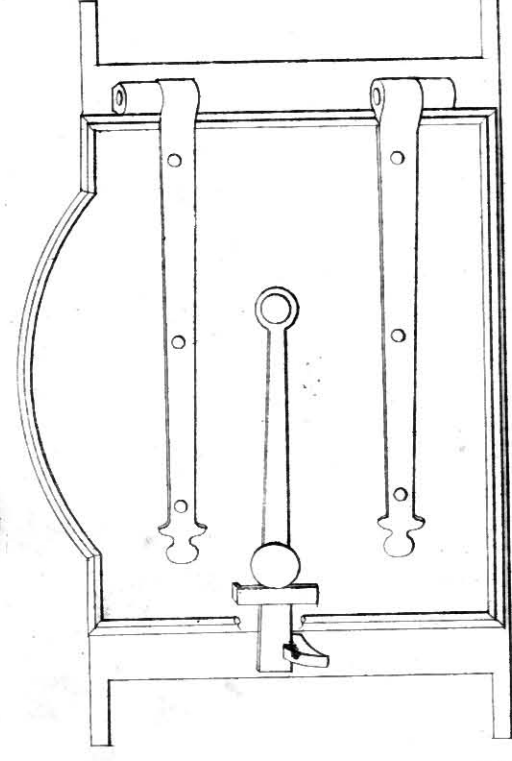

Bakers Door with Cast hinges right or left.
Sizes 14 to 22 inches.

Bakers Door with Cast hinges right or left.
Sizes 14 to 22 inches.

Bakers Door with Cast hinges right or left.
Sizes 14 to 22 inches.

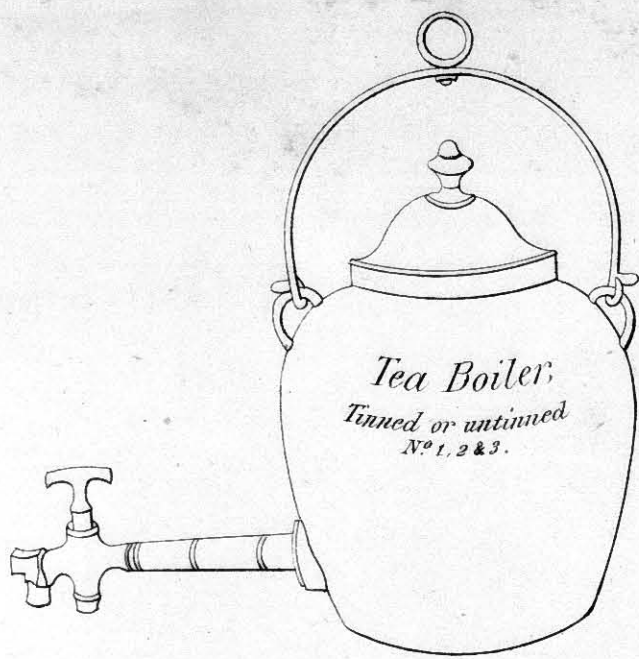

Tea Boiler,
Tinned or untinned
N^o 1, 2 & 3.

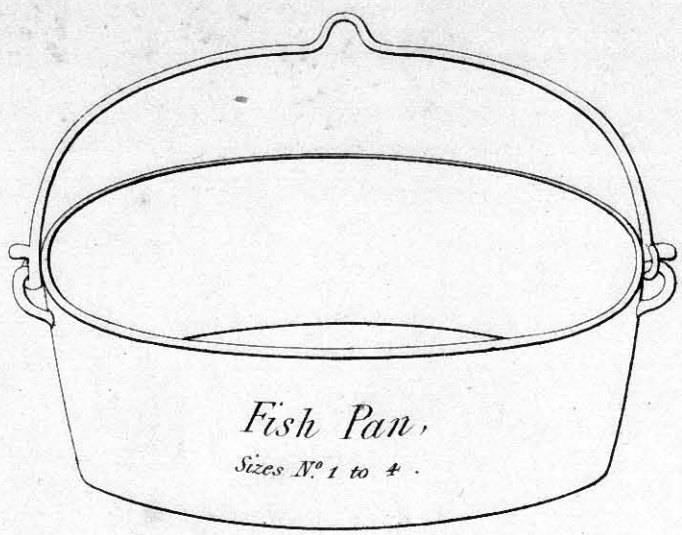

Fish Pan,
Sizes N^o 1 to 4.

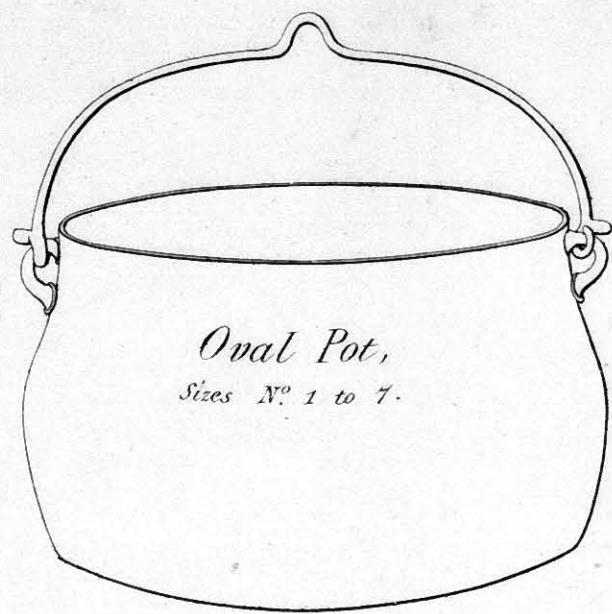

Oval Pot,
Sizes N^o 1 to 7.

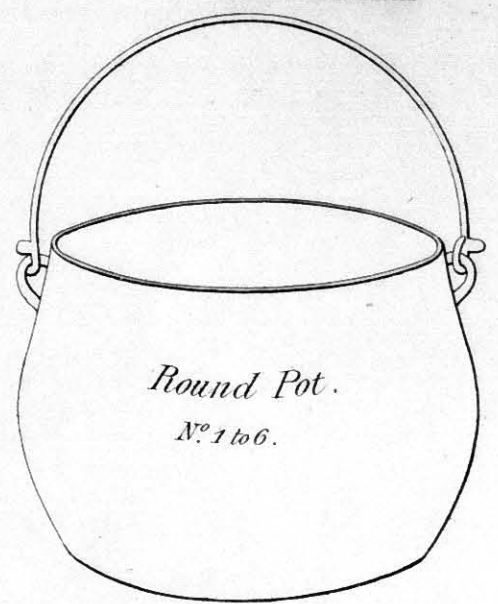

Round Pot,
N^o 1 to 6.



Frying Pan with ears,
Sizes 9 to 18 Inches.

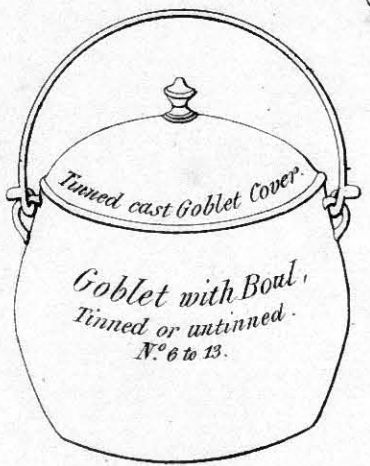

Tinned cast Goblet Cover.
Goblet with Bowl,
Tinned or untinned.
N^o 6 to 13.



Tea Kettle,
Tinned or untinned.
N^o 0 to 7.

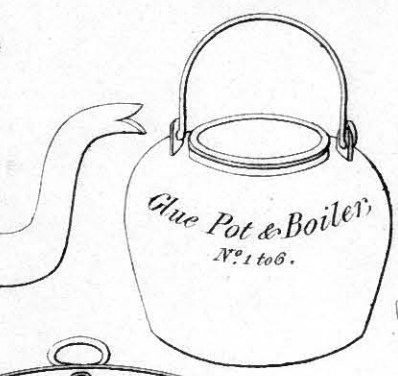

Glue Pot & Boiler,
N^o 1 to 6.



Pan
1/4 to 10 G^s.



Stew Pan,
Tinned or untinned
N^o 1 to 12.

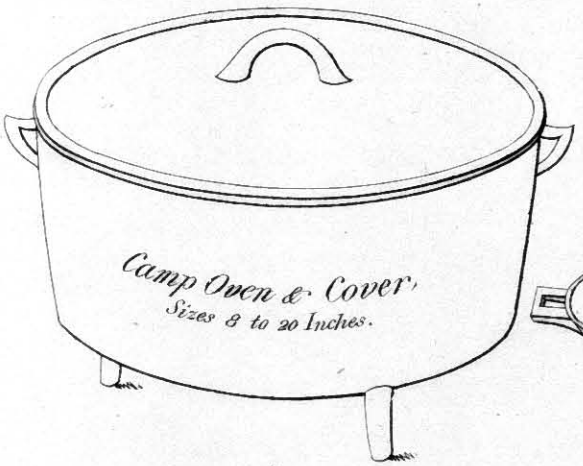

Camp Oven & Cover,
Sizes 8 to 20 Inches.

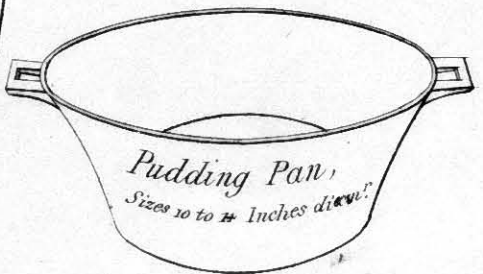

Pudding Pan,
Sizes 10 to 14 Inches dia^r.

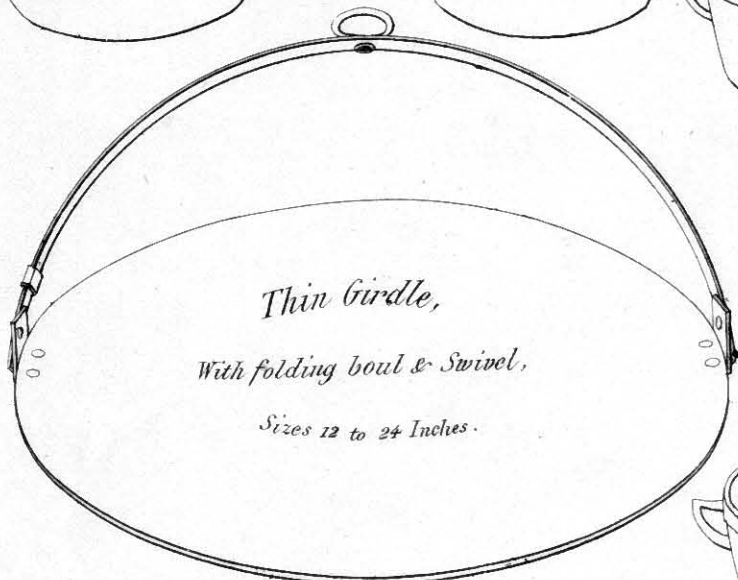

Thin Girdle,
With folding bowl & Swivel,
Sizes 12 to 24 Inches.

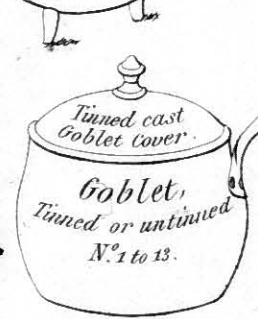

Tinned cast
Goblet Cover.
Goblet,
Tinned or untinned
N^o 1 to 13.

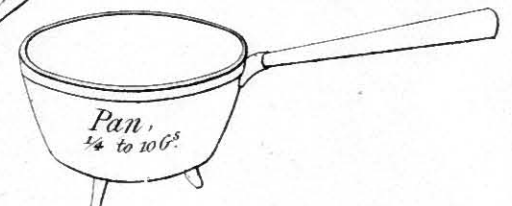

Pan,
1/4 to 10 G^s.



Tea Pot,
New Pattern
N^o 1 & 2.

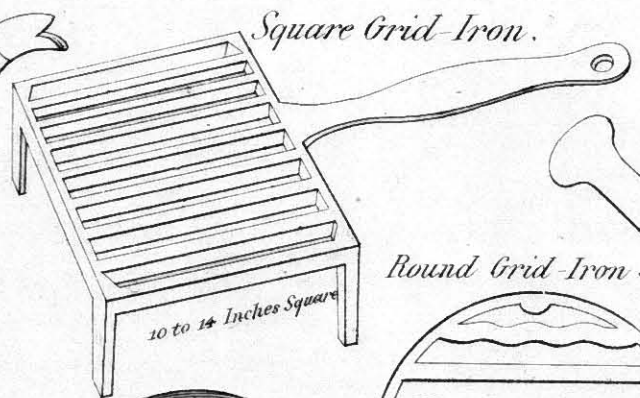

Square Grid-Iron.



Thick Girdle,
either with Holes or Handles,
Sizes 8 to 24 Inches.



Plumbers Pan,
1/4 to 1 G^s.



Pot,
Sizes 1/2 to 60 G^s.



Tea Pot,
Old Pattern
N^o 1 & 2.



Spittoon.

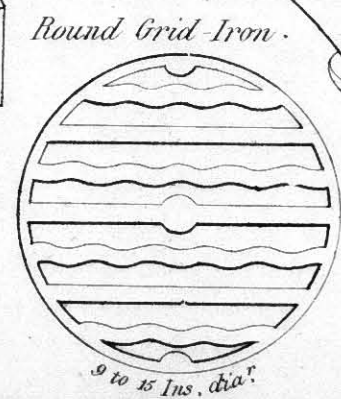

Round Grid-Iron.

9 to 15 Ins. dia^r.



Mortar & Pestle,
N^o 1 to 8.



Frying Pan
with bowl & Swivel,
Sizes 9 to 18 Ins.



S. Wigan Pan & Cover,
Sizes N^o 1 to 11,
7 1/2 to 15 Inches dia^r.

Cisterns.

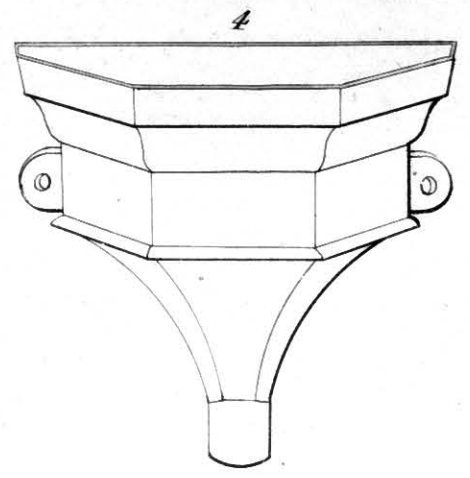
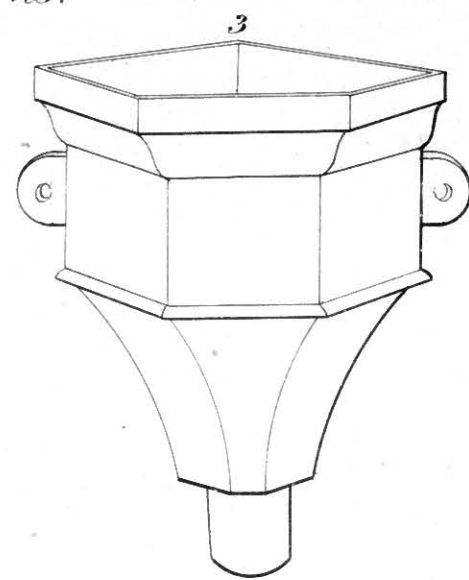
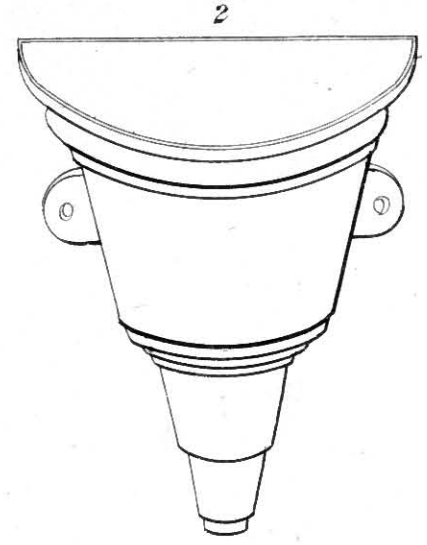
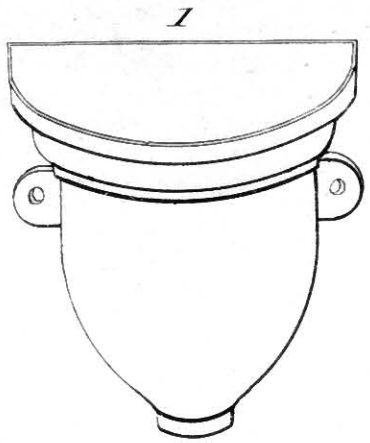

Shoes or Discharging Pipes.

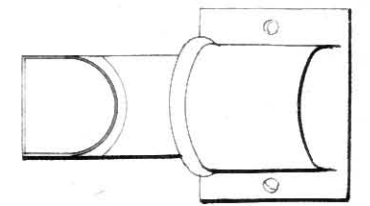
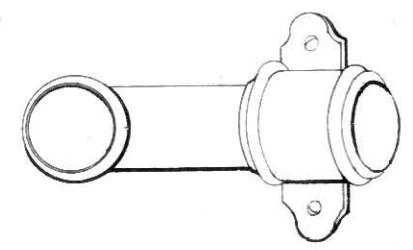
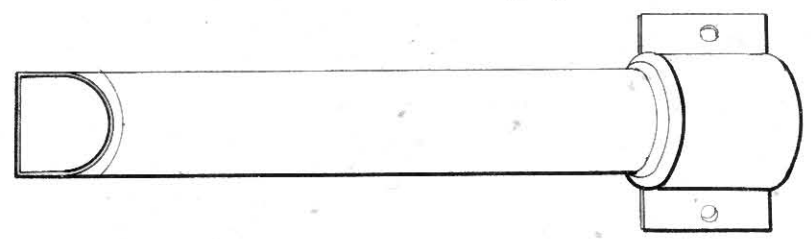
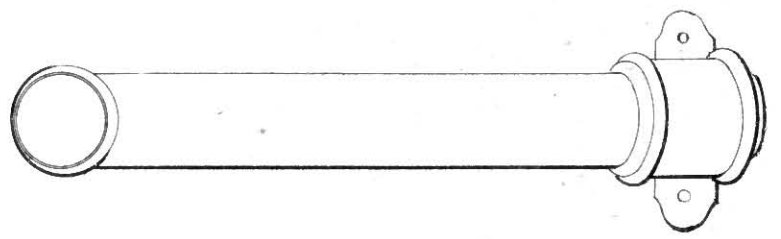

Spouting or Guttering 4, 4 1/2, 5, 6 ins: corner pieces to fit right & left.

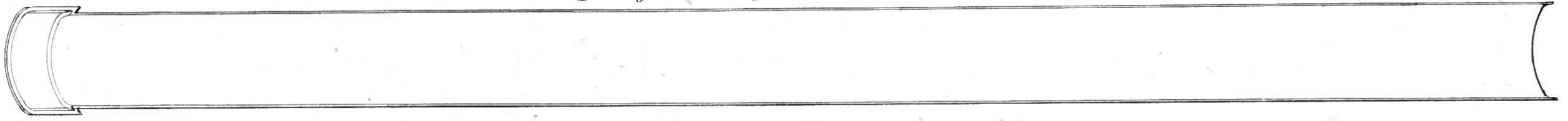

Round Rain Pipe 2, 2 1/2, 3, 3 1/2, 4, 5 Inches.

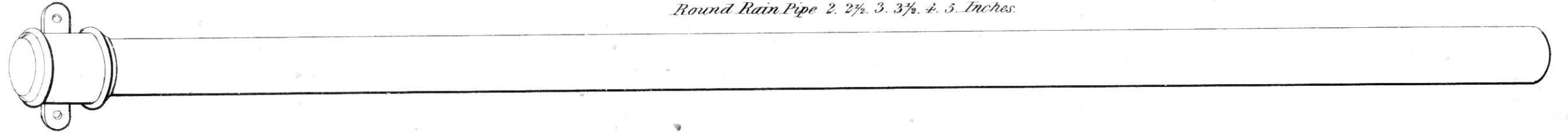

D Rain Pipe 2 1/2, 3, 3 1/2, 4 Inches.

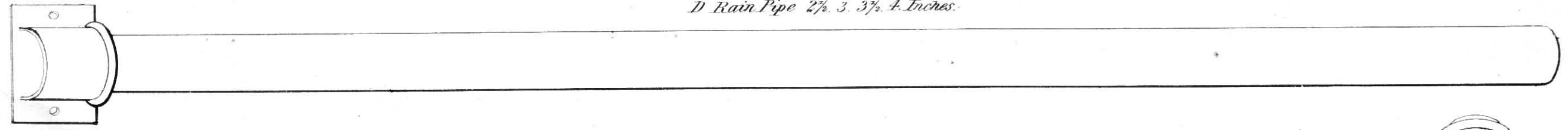

Stove Pipe 4 & 5 Inches.

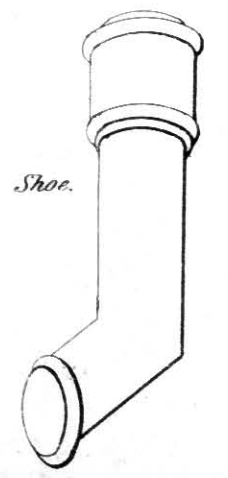
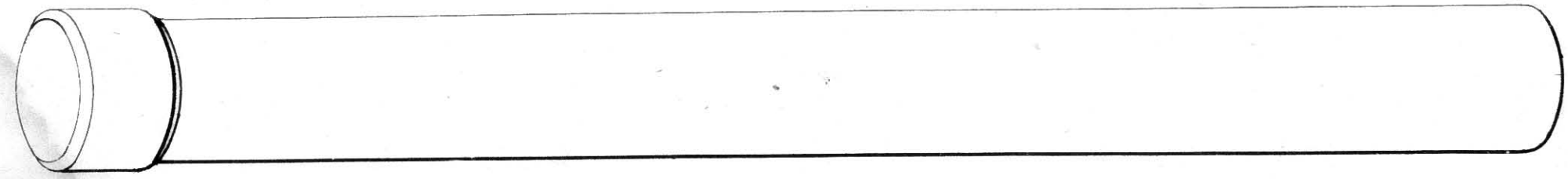

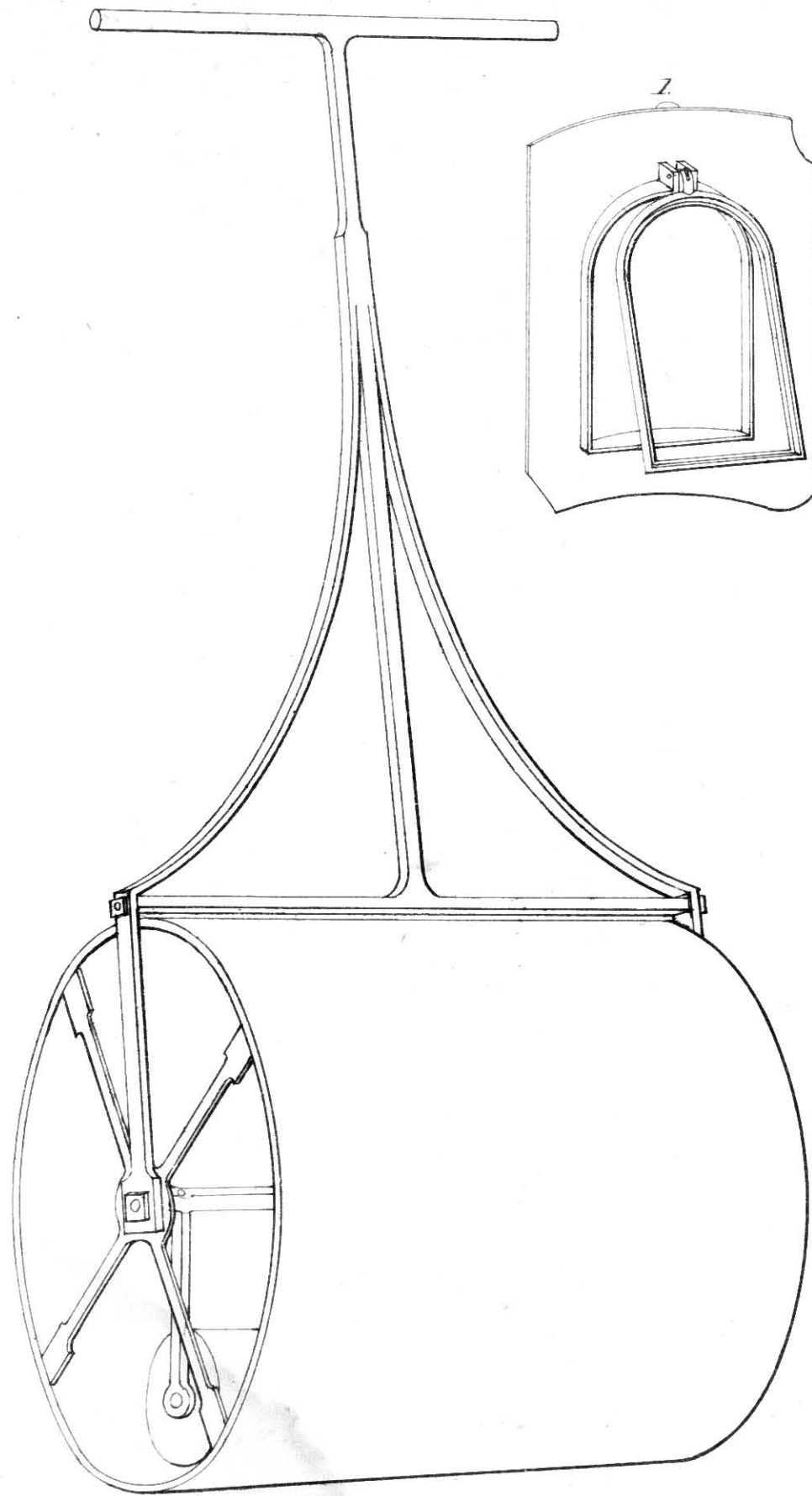

Garden Roller.
14 to 28 Inches

Tiles

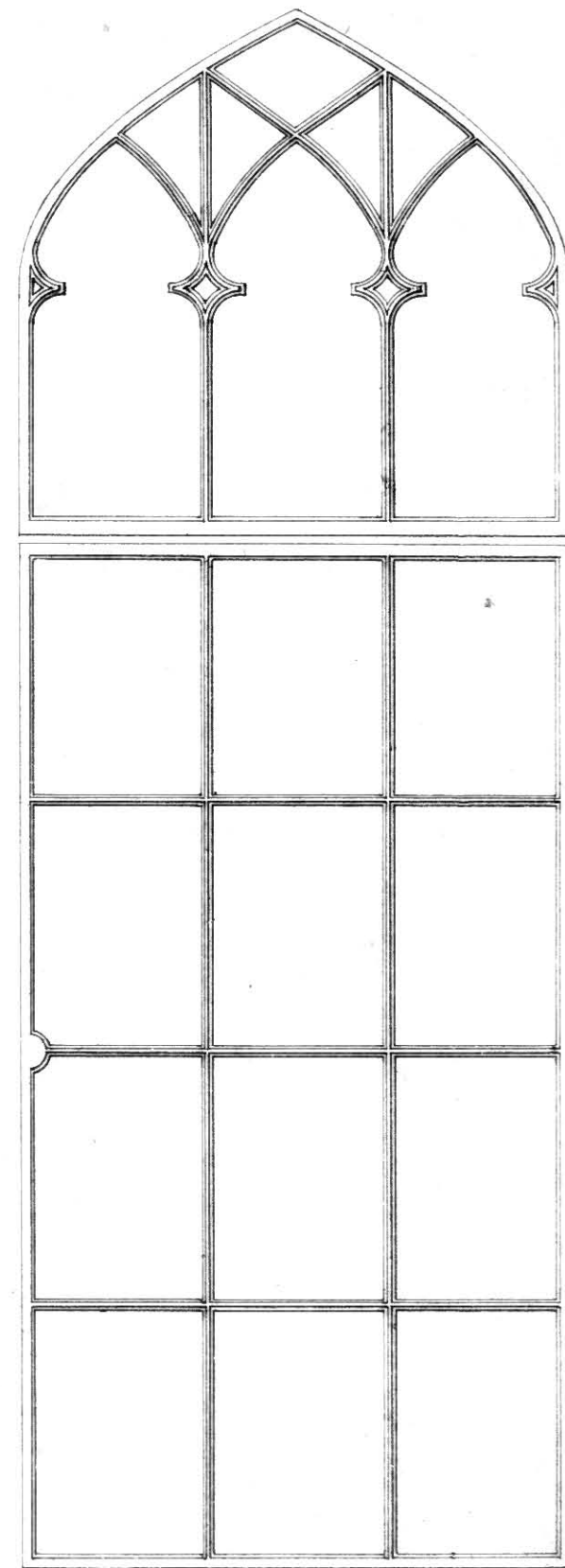
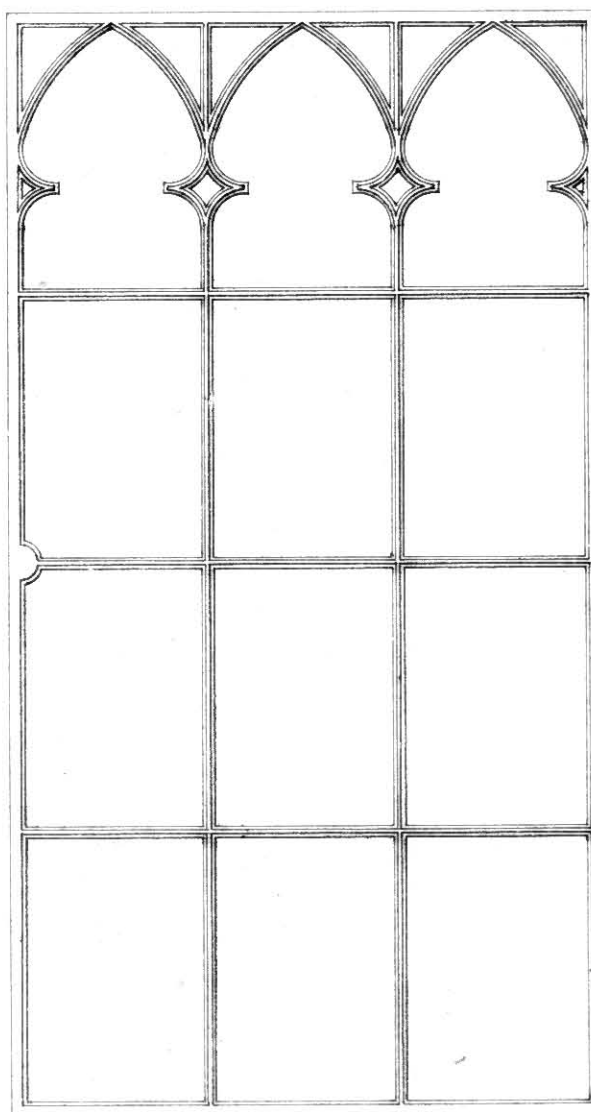
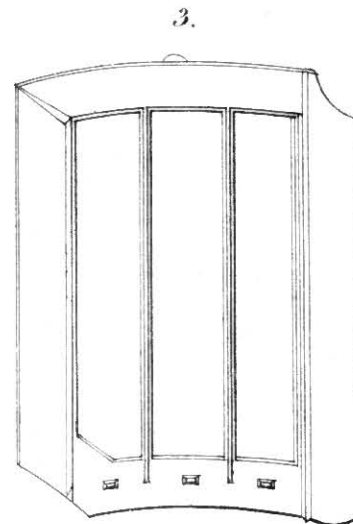
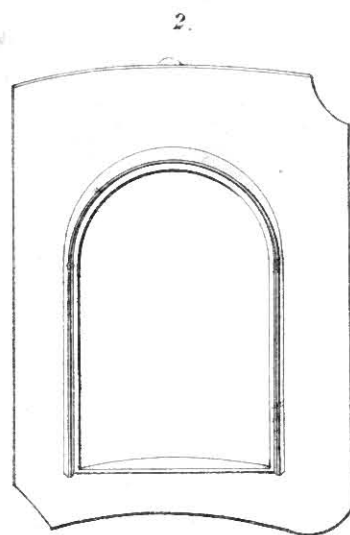
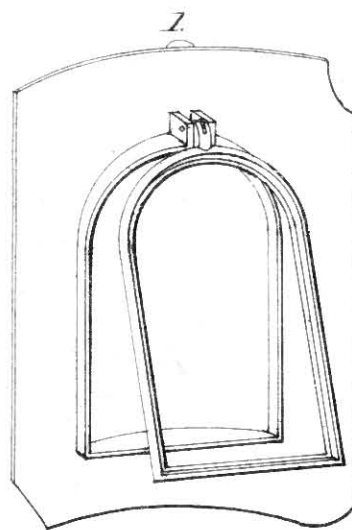

Cottage Casements

28 x 15, 32 x 17, 36 x 19 inches, with either plain or Gothic tops.
Arched tops for Do. in proportion.

Round Frying Pan with cast handle, with or without feet.

9. 10. 11. 12. Inches

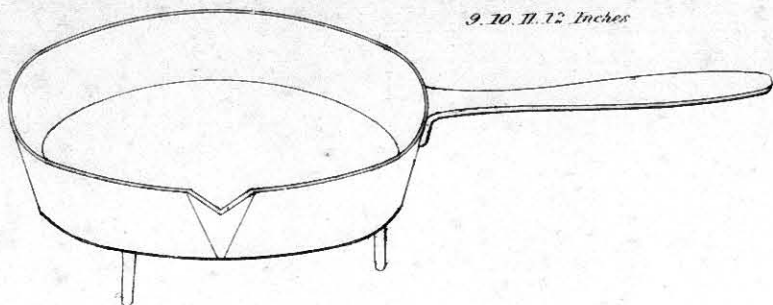

Oval Frying Pan with cast handle, with or without feet.

10. 11. 12. Inches

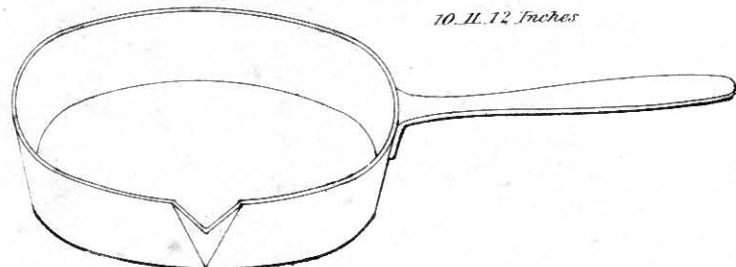

Mason's Stove, 9. 10. 11. 12. 13. ins.

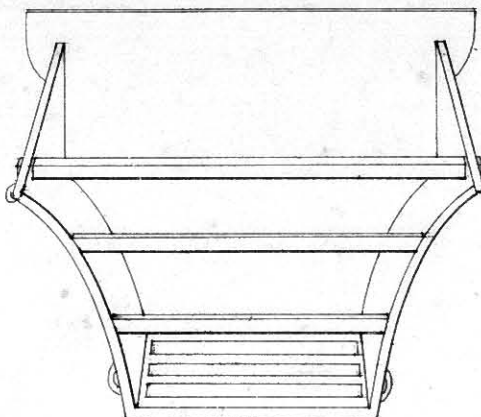

Liverpool Furnace Door with wrought iron hinges

6 to 14 inches

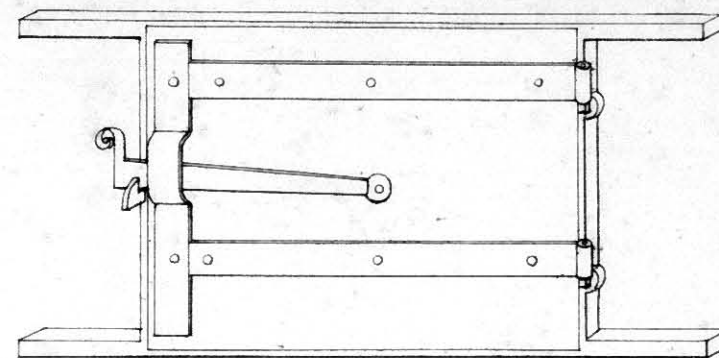

Liverpool Furnace Bars.

12 to 22 Ins. long.

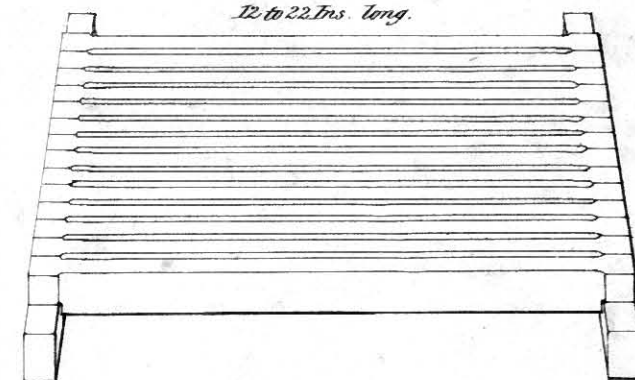

Kentish Cottage Grate N^o 1. 2. 3.
12. 15. 17 ins. wide.

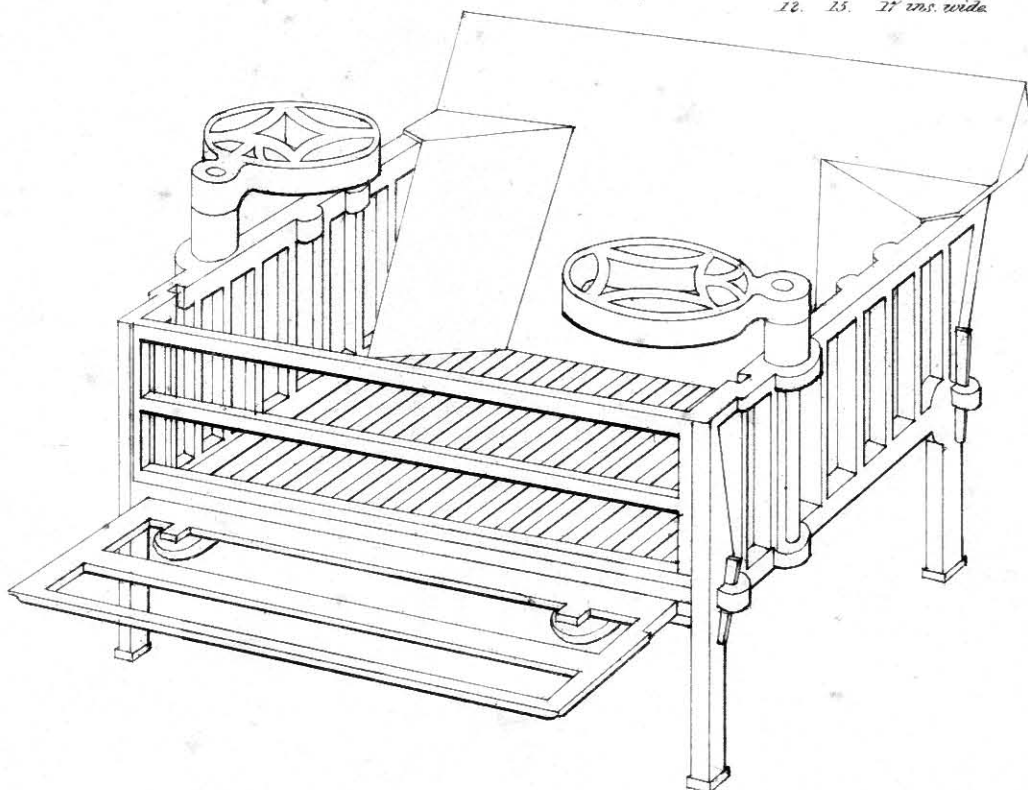

Boat Hearth 10. 11. 12 ins.

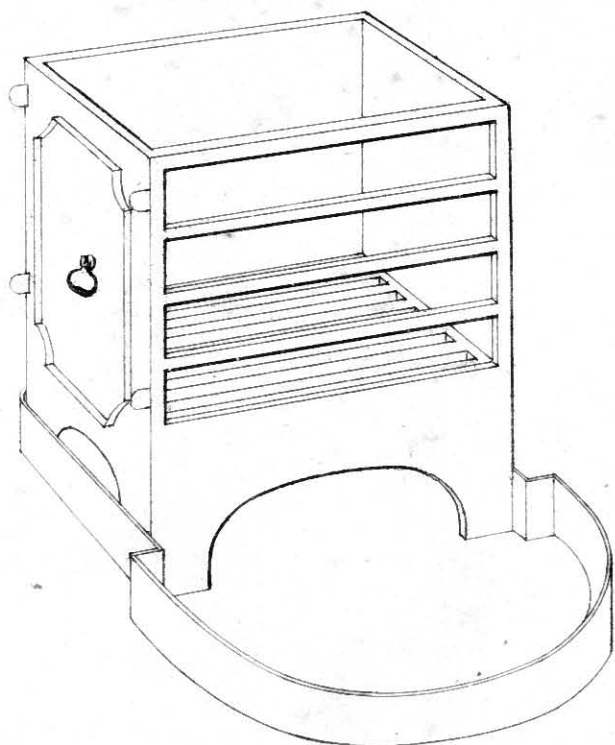

Double Door & Frame N^o 1. 2. 3.
16 x 20. 18 x 24. 20 x 24

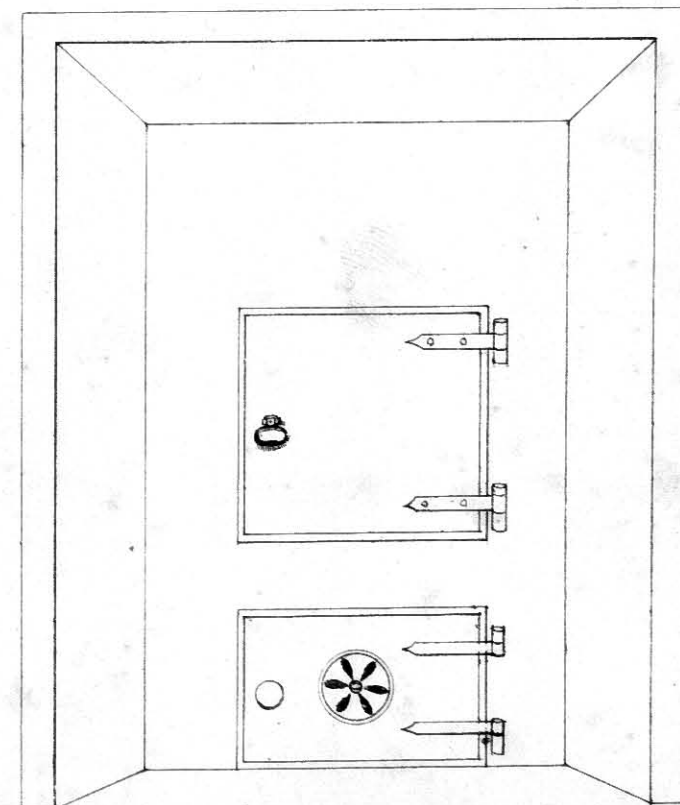

Back Stove with Grate Front
8 1/2 9 1/2 10 11 1/2 Inches.

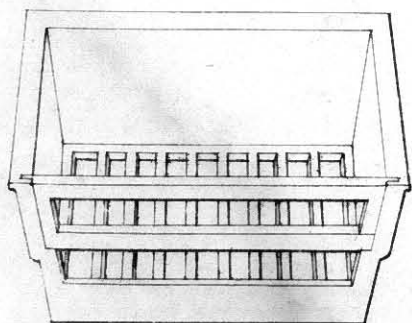

Back Stoves with door fronts
9 1/2 & 11 inches.

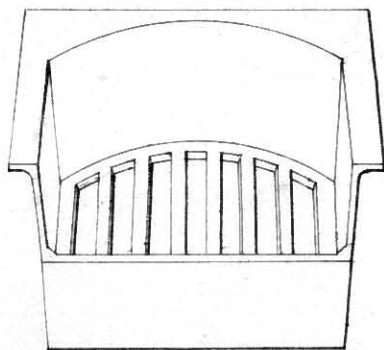

Bath Flats 1 to 6

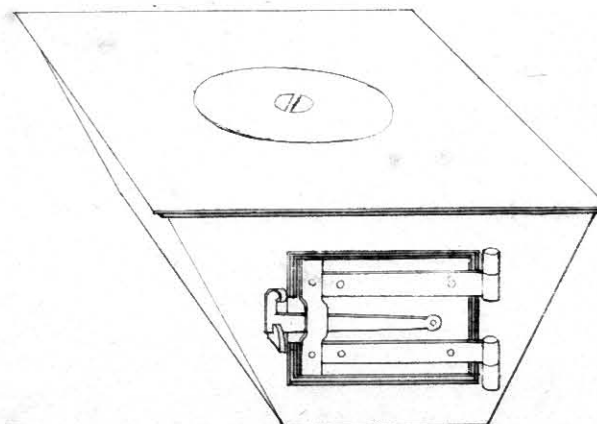

INDEX.

<p>A</p> <p>Ashes, Grates, 68</p> <p>Air Bricks, 91</p> <p>B</p> <p>Bruce Stoves, 17</p> <p>Do. do. 36</p> <p>Brackets, 15</p> <p>Boat Stoves, 71</p> <p>Bedsteads, 76</p> <p>Balcony Panels, 77</p> <p>Balusters, 81</p> <p>Book-Cases, 89</p> <p>Bakers' Doors, 91</p> <p>Boat Hearth, 95</p> <p>Bath Flats, 95</p> <p>Back Stoves, 95</p> <p>Barrow Wheels, 91</p> <p>C</p> <p>Chimney-Piece, 45</p> <p>Cottage Grates, 66</p> <p>Cabin Stoves, 71</p> <p>Clothes Posts, 76</p> <p>Do. do. 80</p> <p>Chimney Cans, 79</p> <p>Counter Rail, 83</p> <p>Coal-hole Grates, 90</p> <p>Cart Naves, 91</p> <p>Cottage Casements, 94</p> <p>D</p> <p>Doors for Hot-House, 71</p> <p>Door Porters, 82</p> <p>Drain Grates, 84</p> <p>Dog Troughs, 84</p> <p>Dampers, 90</p> <p>Dumb Bells, 91</p> <p>Double Door and Frame, 95</p>	<p>E</p> <p>Elliptic Oven, 9</p> <p>Do. B. B. Grate, 10</p> <p>Do. Sham Stoves, 12</p> <p>Do. Grates, 67</p> <p>F</p> <p>Fender Standards, 13</p> <p>Do. do. 83</p> <p>Fenders, 61</p> <p>Fluted Stove, 68</p> <p>Foot Scrapers, 47</p> <p>Furnace Bars, 90, 95</p> <p>Do. Doors, 90, 95</p> <p>Fanner Wheels, 91</p> <p>Fish Pan, 92</p> <p>Frying Pan, 92, 95</p> <p>G</p> <p>Garden Chair, 16, 80</p> <p>Gothic Hall Stove, 66</p> <p>Garden Borders, 80</p> <p>Girdles, 92</p> <p>Garden Roller, 94</p> <p>H</p> <p>Hot Plate, 9</p> <p>Hat Stand, 12</p> <p>Heater Stove, 68</p> <p>Hot-Air Stoves, 70</p> <p>Hand-Glass Frames, 76</p> <p>Hay Rack, 79</p> <p>I</p>	<p>K</p> <p>Kinnaird Register, 11, 24, 54</p> <p>Do. do. 56, 57</p> <p>Kiln Plates, 68</p> <p>Kentish Cottage Grate, 95</p> <p>L</p> <p>Liverpool Ranges, 4</p> <p>Do. Furnace Doors, 95</p> <p>Do. do. Bars, 95</p> <p>M</p> <p>Manger, 79</p> <p>Money Chests, 89</p> <p>Mortar and Pestle, 92</p> <p>Mason's Stove, 95</p> <p>N</p> <p>O</p> <p>Ornaments, 85</p> <p>Oval Pots, 92</p> <p>P</p> <p>Pump, 76</p> <p>Pheasant Feeder, 83</p> <p>Pig Troughs, 84</p> <p>Pots, Pans, &c., 92</p> <p>Pipes, 93</p> <p>Q</p> <p>R</p> <p>Ranges, 1</p> <p>Register Stoves, 17</p> <p>Ridges for Houses, 90</p>	<p>S</p> <p>Sussex Range, 3</p> <p>S. E. Grates, 12</p> <p>Shop Stoves, 69</p> <p>Ship Stoves, 72</p> <p>Sink Traps, 79</p> <p>Skylights, 83</p> <p>Stewing Stoves, 84</p> <p>Stack Pillars, 90</p> <p>Sad Irons, 91</p> <p>Swey, 91</p> <p>Spouting, 93</p> <p>T</p> <p>Trivet, 13</p> <p>Tailor's Stove, 68</p> <p>Troughs, 84</p> <p>Tue Iron, 91</p> <p>Tailor's Irons, 91</p> <p>Truck Wheels, 91</p> <p>Tea Boilers, 92</p> <p>Tea Kettles, 92</p> <p>Tile Lights, 94</p> <p>U</p> <p>Umbrella Stands, 11</p> <p>University Grates, Registered, 46</p> <p>V</p> <p>Ventilators, 76</p> <p>W</p> <p>Wheels, 91</p> <p>X</p> <p>Y</p> <p>Z</p>
--	--	---	--

