

# GENERAL CASTINGS



**CALLENDAR IRON CO., LIMITED,  
FALKIRK.**

Telephones: 29 and 30 Falkirk.

Telegrams: "Callendar, Falkirk."

*London Address:* Norwich House, 13 Southampton Street, High Holborn, W.C. 1.

Telephone: Museum 9477.

*Glasgow Address:* 102 West Regent Street.

Telephone: Douglas 4204.



# INDEX.

<b>A</b>		Page
Aberdeen Soot Boxes	....	27
Air Bricks	....	21
Air Gratings	....	19, 20
Ashbin Brackets	....	17
Ash Grates	....	23
<b>B</b>		
Balusters, Outside,	....	8
,, Stair	....	9, 10, 11
Bar Weights	....	34
Barrow Wheels	....	35
Bed Sockets	....	23
Bed Standards	....	23
Bell Traps	....	24
Blower Grates	....	23
Boiler Hole Plates	....	27
Bottom Grates	....	27
Box Iron Heaters	....	34
Buchan Trap	....	24
Brackets, Shelf	....	18
,, Pedestal,	....	18
,, Cantilever	....	17
,, Ashbin	....	17
<b>C</b>		
Camp Ovens	....	36
Cantilever Brackets	....	17
Cassada Plates,	....	36
Chair Arms, Garden,	....	28, 29
Channel Grates	....	22
Channel Scrapers	....	33
Clark's Traps,	....	24
Clothes Posts	....	32
,, Sockets	....	32
Coal Savers	....	27
Continuous Deadlights	....	3
Corrugated Skylights	....	2
Coping	....	6
Cresting	....	13
Cross Rail Standards	....	6, 7
<b>D</b>		
Dampers	....	27
Danish Pans	....	36
Deadlights	....	1, 2, 3
Deck Flanges	....	34
Door Step Gratings	....	20
Doors and Grates, Furnace	....	27
Drain Grates	....	22
Drinking Cup	....	34
<b>E</b>		
Earth Rammer	....	23
<b>F</b>		
False Bottoms	....	27
Fence Ratchets,	....	34
Finials,	....	14
Fish Pans	....	34
Flue Cleaning Boxes	....	27
Foot Scrapers	....	33

<b>Fry Pans</b>		....	36
Furnace Doors and Grates	....	27	
Furnace Bars	....	27	
,, Dampers	....	27	
Furnace Pans,	....	26	
<b>G</b>			
Garden Seats	....	28	
Garden Chair Arms	....	28, 29	
Garden Grates	....	22	
Gates and Railing	....	4, 5, 6	
Girdles	....	36	
Grates, Drain	....	22, 23	
,, Furnace	....	27	
Gratings	....	19, 20, 24	
Grave Number Plates	....	18	
Grubber Wheels	....	35	
Gulley Grates	....	22	
Gulley Traps	....	24	
<b>H</b>			
Hard Oval Pots	....	36	
Hart Trap Grating	....	24	
Hay Racks	....	35	
Heads, Standard	....	9	
Heaters, Box-Iron	....	34	
Hinged Soot Boxes	....	27	
<b>L</b>			
Lasts, Shoemakers'	....	34	
Liverpool Traps	....	24	
Louvre Air Bricks	....	21	
<b>M</b>			
Mangers	....	35	
Manhole Frames and Covers	....	25	
,, Step Iron	....	25	
Main Balusters	....	12	
Mica Flap Ventilator	....	24	
<b>N</b>			
Newels	....	12	
Niggets	....	27	
Number Plates	....	18	
<b>O</b>			
Ornamental Gratings	....	19, 20	
Outside Balusters	....	8	
Oval Pots	....	36	
<b>P</b>			
Pan Skylights	....	2	
Pedestal Brackets	....	18	
Pillars, Tomb	....	16	
Poultry Troughs	....	18	
Pans, Furnace	....	26	
,, Fish	....	34	
Perforated Fire Cheeks	....	27	
Plumber Pots	....	23	
Posts, Clothes	....	32	
Pots	....	36	

<b>R</b>		Page
Railing	....	4, 5, 6
Rammers, Earth	....	23
Refreshment Room Tables	....	30, 31
<b>S</b>		
Sad Irons	....	34
Scrapers	....	33
Seats, Garden	....	28
Sewer Grate	....	25
Shoemakers' Lasts,	....	34
Shelf Brackets	....	18
Skid Irons	....	34
Skylights	....	1, 2
Sliding Air Bricks	....	21
Sockets, Bed	....	23
,, Clothes Post	....	32
Soot Boxes	....	27
Standards, Cross Rail	....	6, 7
Standard Heads	....	9
Stair Balusters	....	9, 10, 11
Stair Step Nosings	....	13
Step Iron, Manhole	....	25
Step Risers	....	13
Stop Cock Cover	....	24
Stop Tap Box	....	25
Storm Bars	....	17
Strainers, Wire	....	34
Surface Box	....	24
Sweeps' Balls	....	34
Sun Dials	....	31
Standards, Bed	....	23
Stob Mallet	....	34
<b>T</b>		
Tables	....	30, 31
Table Standards	....	30, 31
Tailors' Irons	....	34
Tobies	....	24
Tomb Pillars	....	16
,, Railing	....	15
Traps	....	24
Troughs	....	18
Truck Wheels	....	35
<b>U</b>		
Umbrella Stand	....	34
<b>V</b>		
Ventilating Gratings,	....	19, 20
Ventilator, Mica Flap	....	24
<b>W</b>		
Water Bars	....	17
Wheels	....	35
Wigan Pans	....	23
Wire Strainers	....	34
Weights, Bar	....	34
Wringer Plates	....	32

# SKYLIGHTS AND DEADLIGHTS.

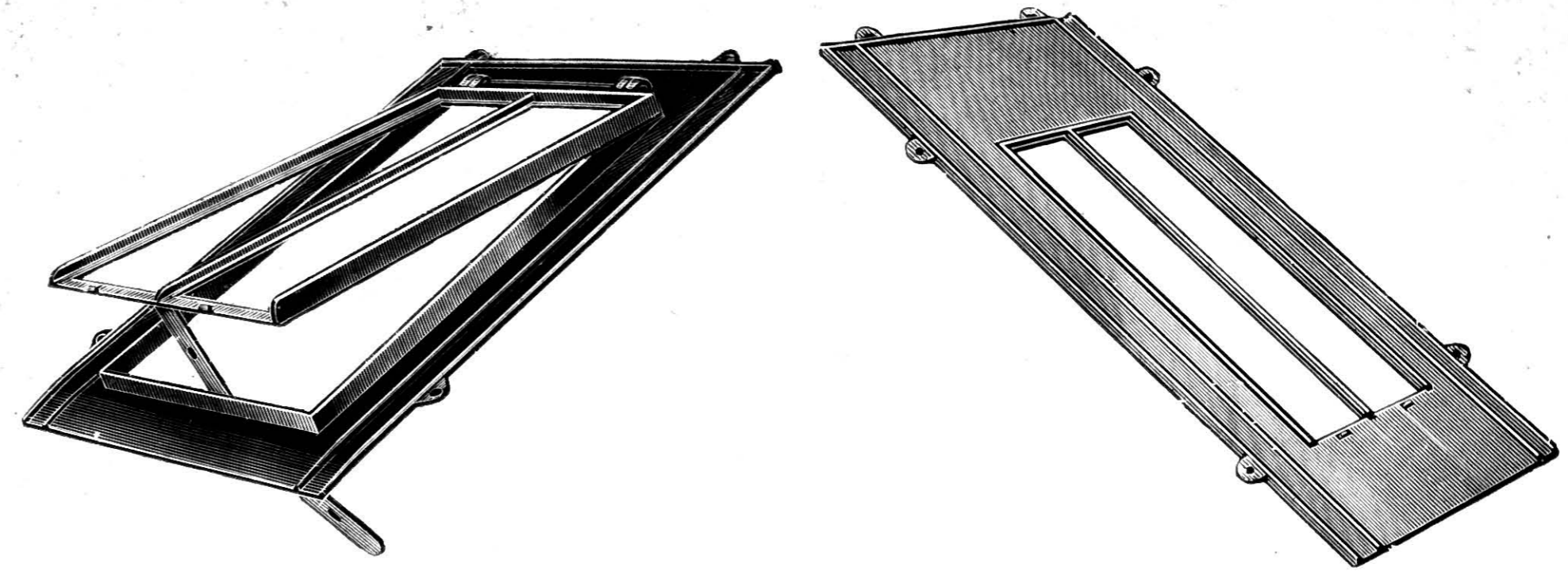

Sizes.	Opening Lights.		Deadlights.		Sizes.	Opening Lights.		Deadlights.	
	Painted	Unpainted	Painted	Unpainted		Painted	Unpainted	Painted	Unpainted
8 x 10 ins.	12 5	12 -	8 3	8 -	18 x 36 ins.	30 1	28 11	19 1	18 4
9 x 12 ..	14 8	14 1	9 4	9 -	20 x 30 ..	27 1	26 1	18 7	17 11
10 x 14 ..	16 4	15 9	10 5	10 1	20 x 36 ..	30 4	29 1	20 4	19 7
12 x 16 ..	16 8	16 -	11 -	10 7	24 x 30 ..	32 -	30 8	21 7	20 9
13 x 18 ..	18 4	17 7	12 8	12 3	24 x 36 ..	34 8	33 4	22 9	22 -
14 x 20 ..	21 9	21 -	14 1	13 8	24 x 42 ..	41 7	40 -	28 -	27 1
16 x 24 ..	22 4	21 7	15 1	14 8	30 x 36 ..	46 8	44 9	33 -	31 8
16 x 27 ..	24 5	23 5	16 1	15 8	30 x 42 ..	50 4	48 5	35 5	34 1
16 x 30 ..	25 8	24 8	16 9	16 1	36 x 30 ..	57 9	55 8	37 7	36 3
18 x 24 ..					36 x 36 ..	67 1	64 5	44 3	42 8
18 x 27 ..					36 x 42 ..	73 4	70 4	49 4	47 5
18 x 30 ..					36 x 48 ..				

## No. 3 SKYLIGHT.

With Centre Opening Pane.

	30 x 18	33 x 24	36 x 30 ins.
Painted,	25 8	33 -	50 4 each.
Unpainted,	24 8	31 6	48 5 ..
	36 x 36	42 x 36	48 x 36 ins.
Painted,	57 9	67 1	73 4 each.
Unpainted,	55 8	64 5	70 4 ..

## No. 3 DEADLIGHT.

30 x 24 36 x 24 36 x 30 42 x 24 ins.

	30 x 24	36 x 24	36 x 30	42 x 24 ins.
Painted,	21 7	22 9	35 5	28 - each.
Unpainted	20 9	22 -	34 1	27 1 ..
	42 x 30	42 x 36	48 x 36 ins.	
Painted,	35 5	44 3	49 4 each.	
Unpainted,	34 1	42 8	47 5 ..	

## EXTRAS.

If fitted with Ordinary Pulleys, 4/- extra.  
 If fitted with Leggott's Patent Openers—  
 No. 3, 12/- No. 5, 15/- No. 7, 21/4 each.  
 Preparing only Rooflights for Leggott's  
 Openers, 1/7 each.

No. 4 SKYLIGHT, 36 x 48 ins., with Opening  
 Centre Pane in top half only—  
 Painted, 73/4; Unpainted, 70/4

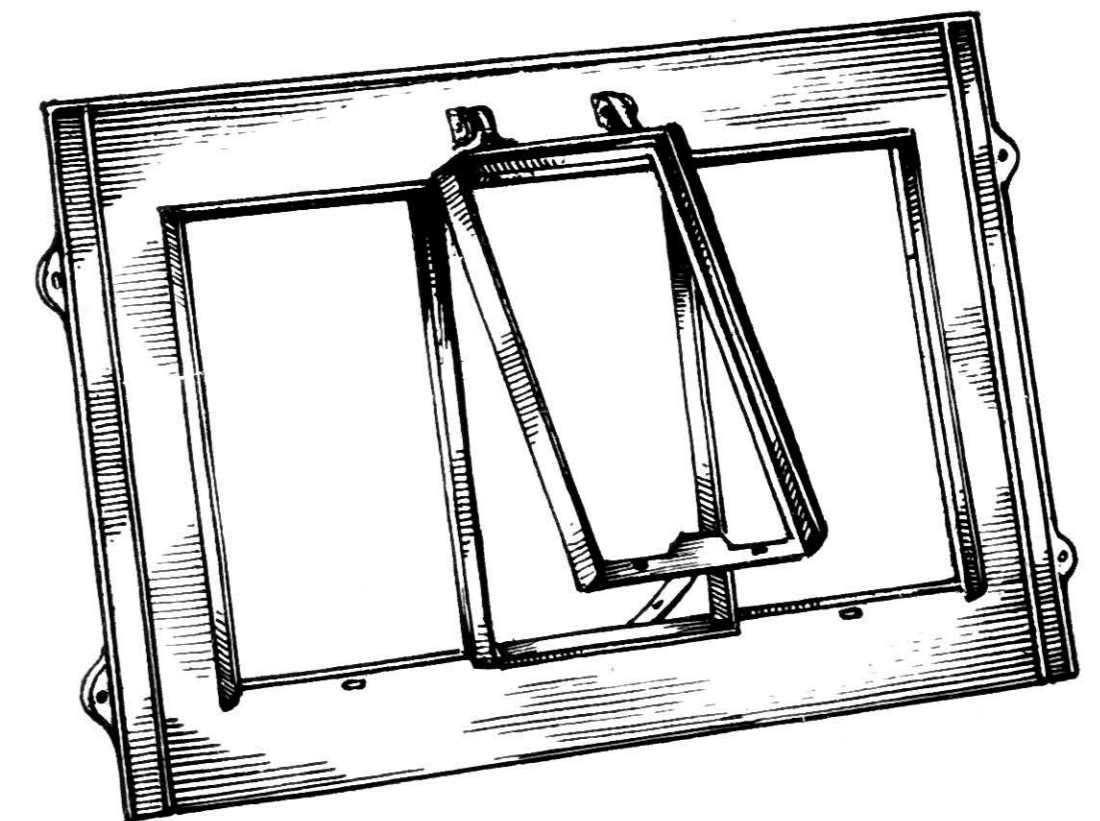



# CAST-IRON CORRUGATED ROOF LIGHTS.

Made to suit 3 in. Corrugations.

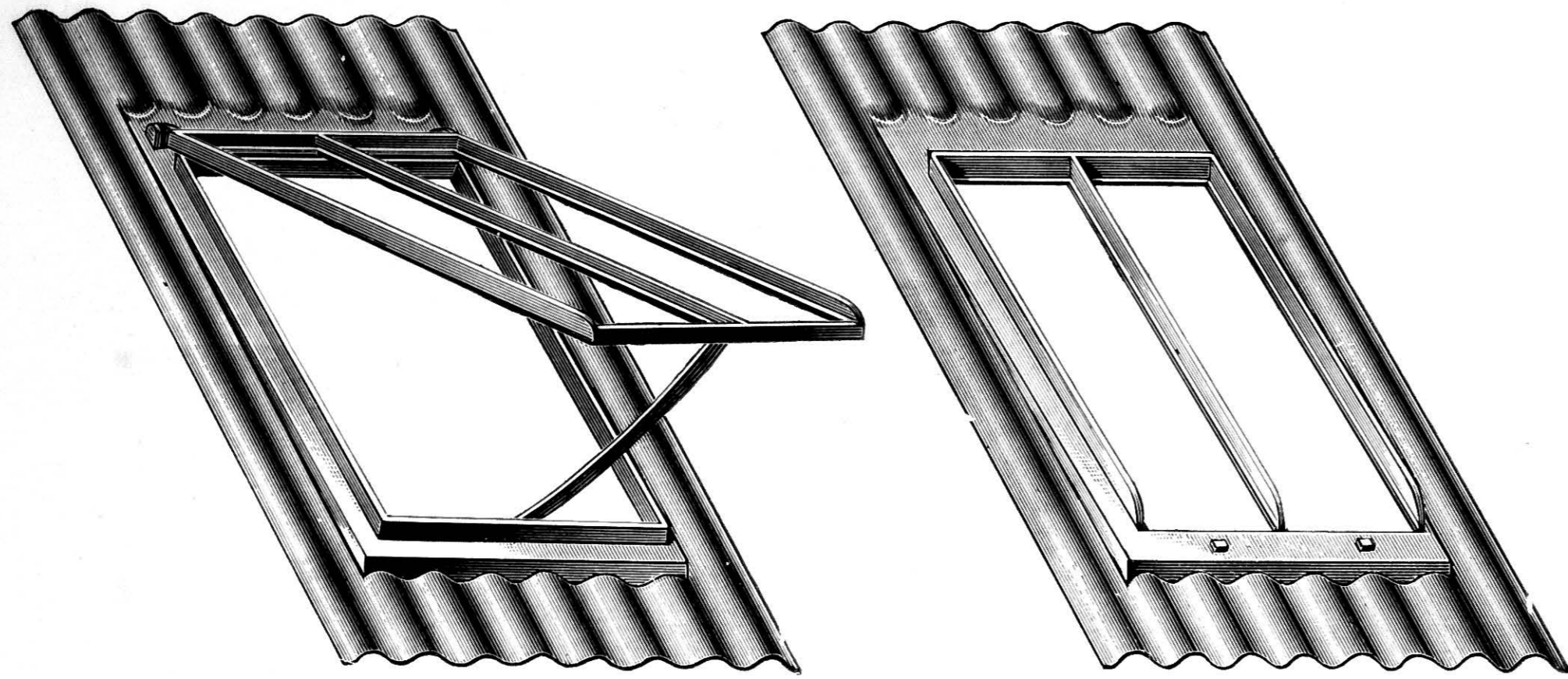

No. 5 Skylight.

No. 6 Deadlight.

W. H.	Painted.	W. H.	Painted.
14 × 20 ins.,	19/- each.	16 × 24 ins.,	15/- each.
16 × 24 ,,	21/6 ,,	16 × 30 ,,	18/8 ,,
16 × 30 ,,	25/8 ,,	20 × 36 ,,	25/8 ,,
20 × 36 ,,	35/9 ,,		

Fitted with Ordinary Pulleys, ..... 4/- extra.

Fitted with Leggott's Patent Opener, No. 3. 12/- No. 5. 15/- No. 7. 21/4 extra.

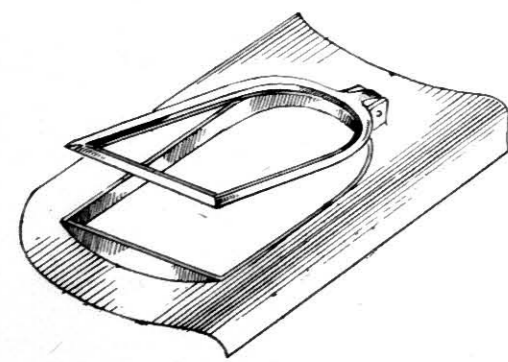

PAN SKYLIGHT.

Size, ..... 14 3/4 × 10 ins. overall.  
4/6 each.

# CONTINUOUS DEADLIGHTS.

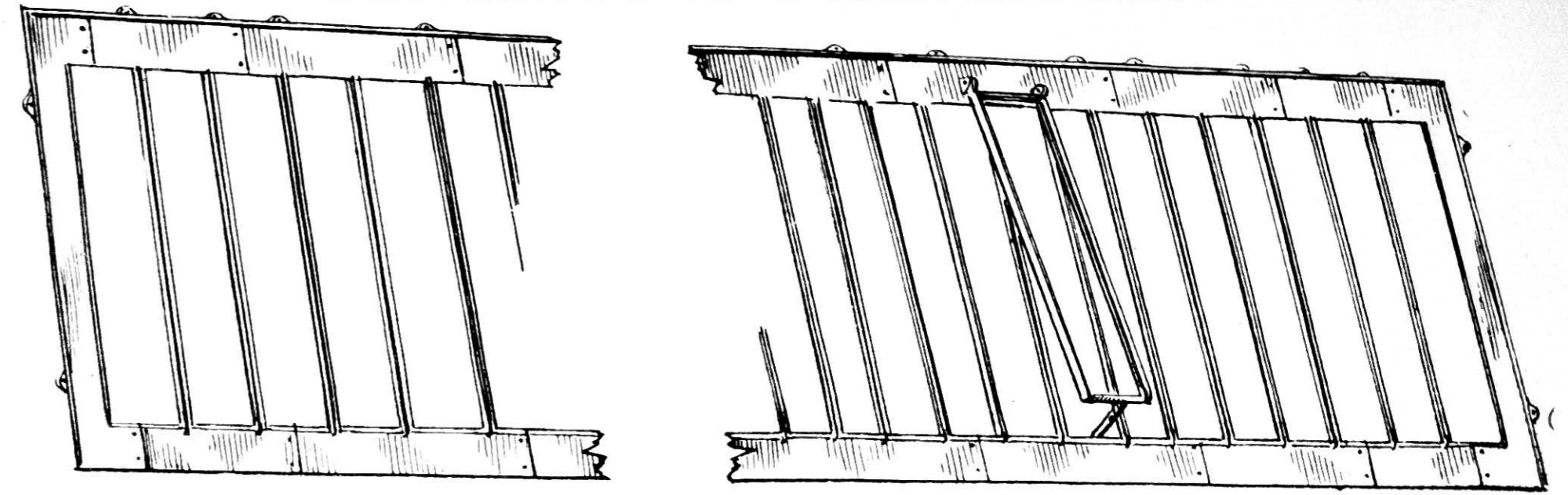

TOP PARTS PLAIN

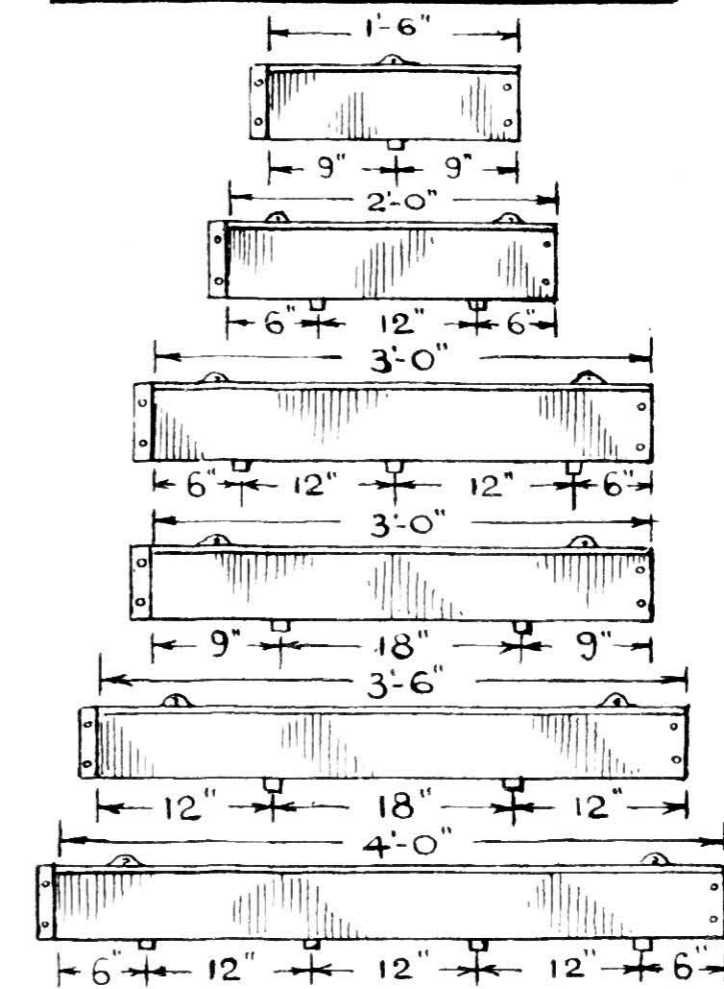

BOTTOM PARTS TO CORRESPOND

TOP PARTS WITH OPENING PANES

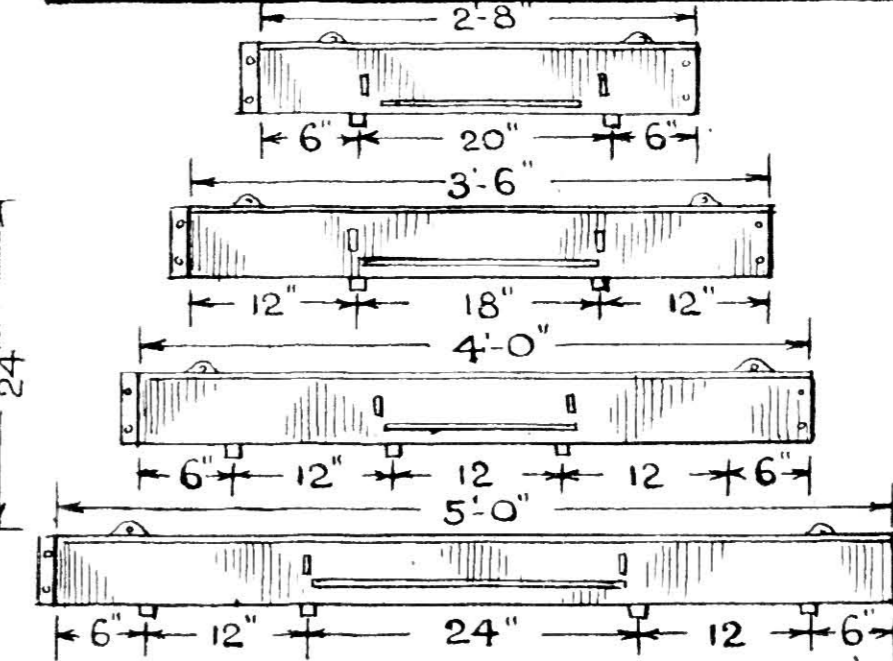

BOTTOM PARTS TO CORRESPOND

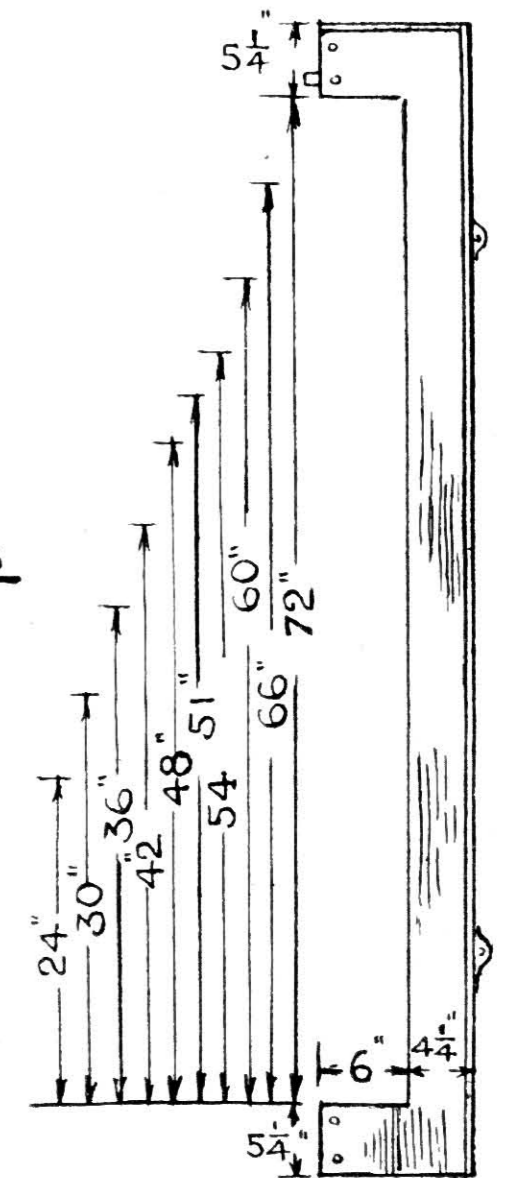

RIGHT HAND ENDS

LEFT HAND ENDS

CONTINUOUS DEADLIGHTS, as detailed above.											
Openings,	24	30	36	42	48	51	54	60	66	72 ins. high.	
Overall Sizes,	34 1/2	40 1/2	46 1/2	52 1/2	58 1/2	61 1/2	64 1/2	70 1/2	76 1/2	82 1/2 ,,	
Prices, Tops and Bottoms with Astragals,	5/3	5/6	6/-	7/6	8/3	9/-	10/6	11/3	12/-	12/9 per lin. ft.	
,, Right and Left Hand Ends,	12/-	12/9	13/6	15/9	18/-	21/-	24/-	27/-	30/-	31/6 per pair.	
With Opening Pane as illustrated,		12	18	20	24	ins. wide × 36, 42, 48 ins. high.					
	24/-	25/6	27/-	30/-	extra.						



# GATES AND RAILINGS.

No. 60.

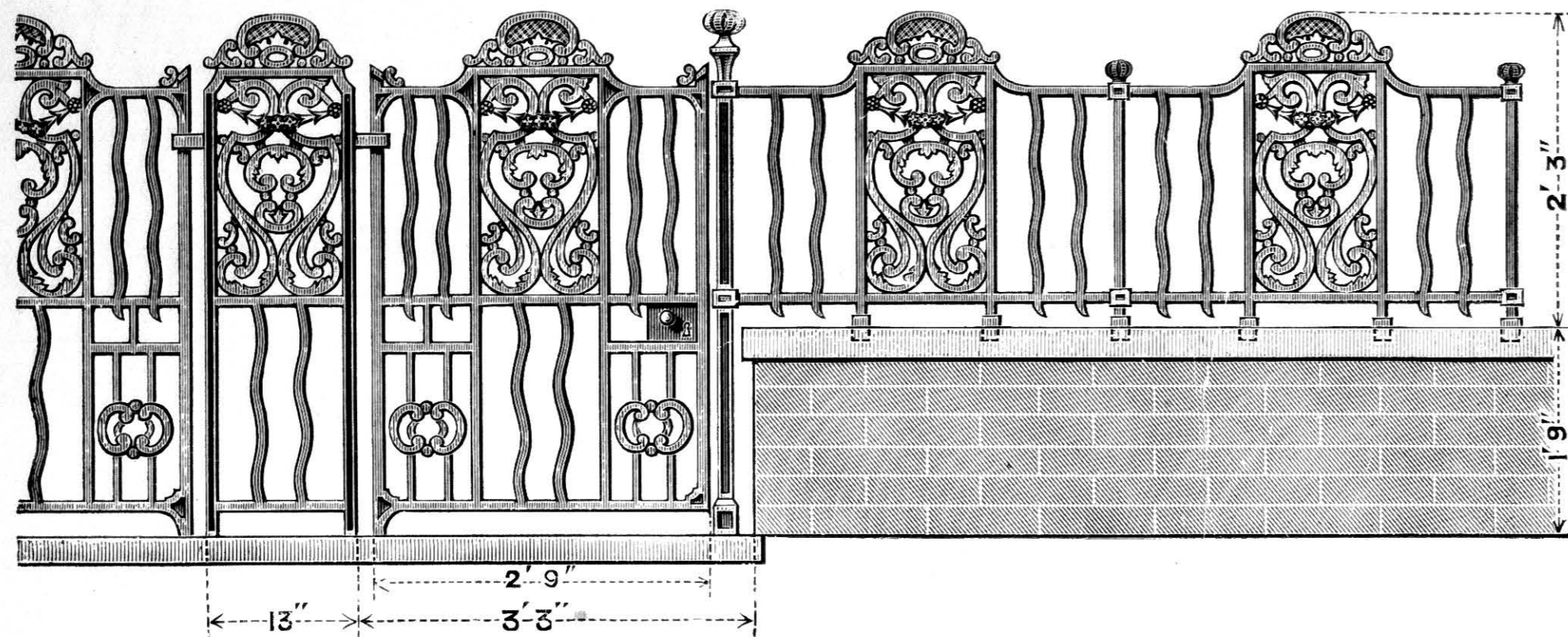

No. 60 Gate, fitted with Lock,	66/- each.
"    "    "    Latch,	45/- "
Gate Standards with Braces,	34/6 per pair.
Pilaster, with Double Brace,	31/6 each.
Railing, 27 ins. high,	18/- per yard.
Railing Standards, Intermediate or Corner,	5/6 each.

Cutting and laying out to plan charged extra.

No. 70.

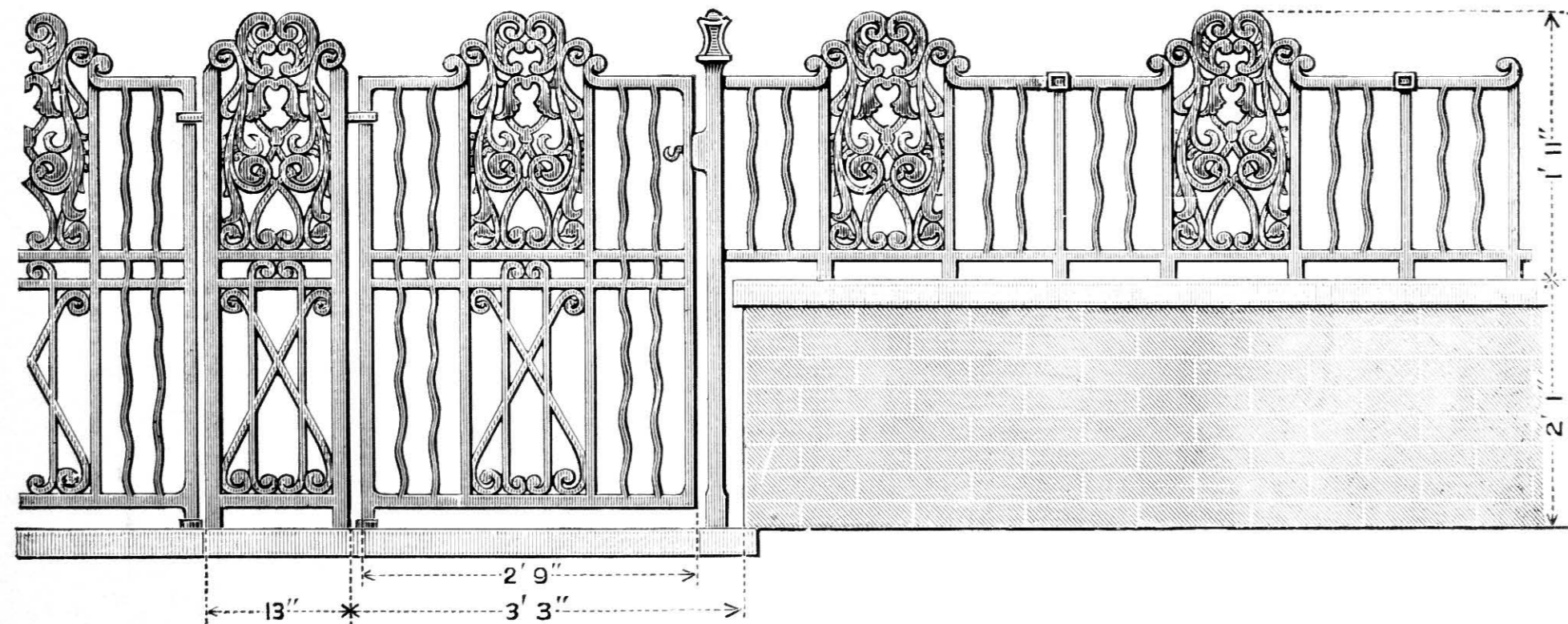

No. 70 Gate, fitted with Lock,	66/- each.
"    "    "    Latch,	45/- "
Gate Standards with Braces,	34/6 per pair.
Pilaster, with Double Brace,	34/6 each.
Railing, 23 ins. high,	18/- per yard.
Railing Standards, Intermediate or Corner, Painted One Coat,	5/6 each.

Cutting and laying out to plan charged extra.

# GATES AND RAILINGS.

No. 20.

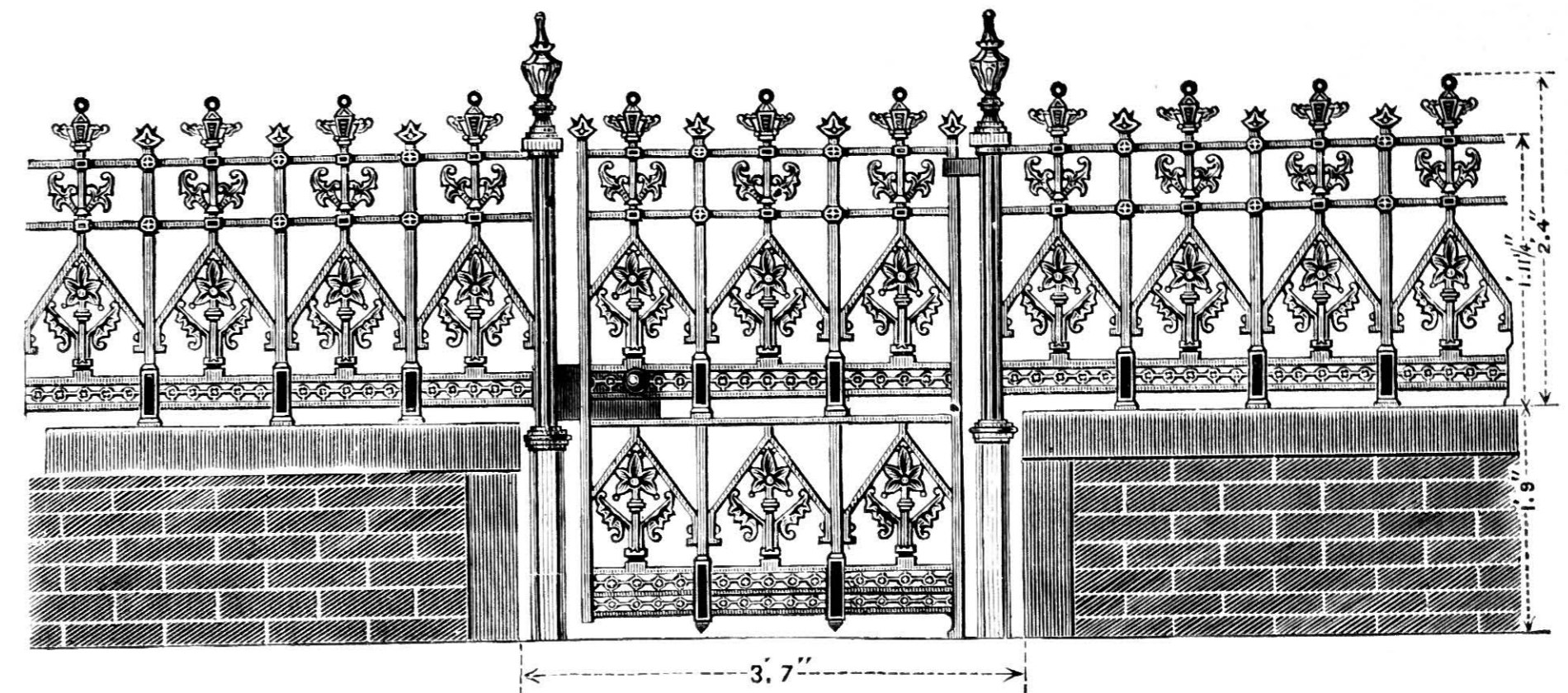

No. 20 Gate, fitted with Lock,	75/- each.
"    "    "    Latch,	54/- "
Gate Standards, with Braces,	43/6 per pair.
Railing, 28 ins. high,	20/3 per yard.
Railing Standards, Intermediate or Corner,	9/- each.

Cutting and laying out to plan charged extra.

No. 38.

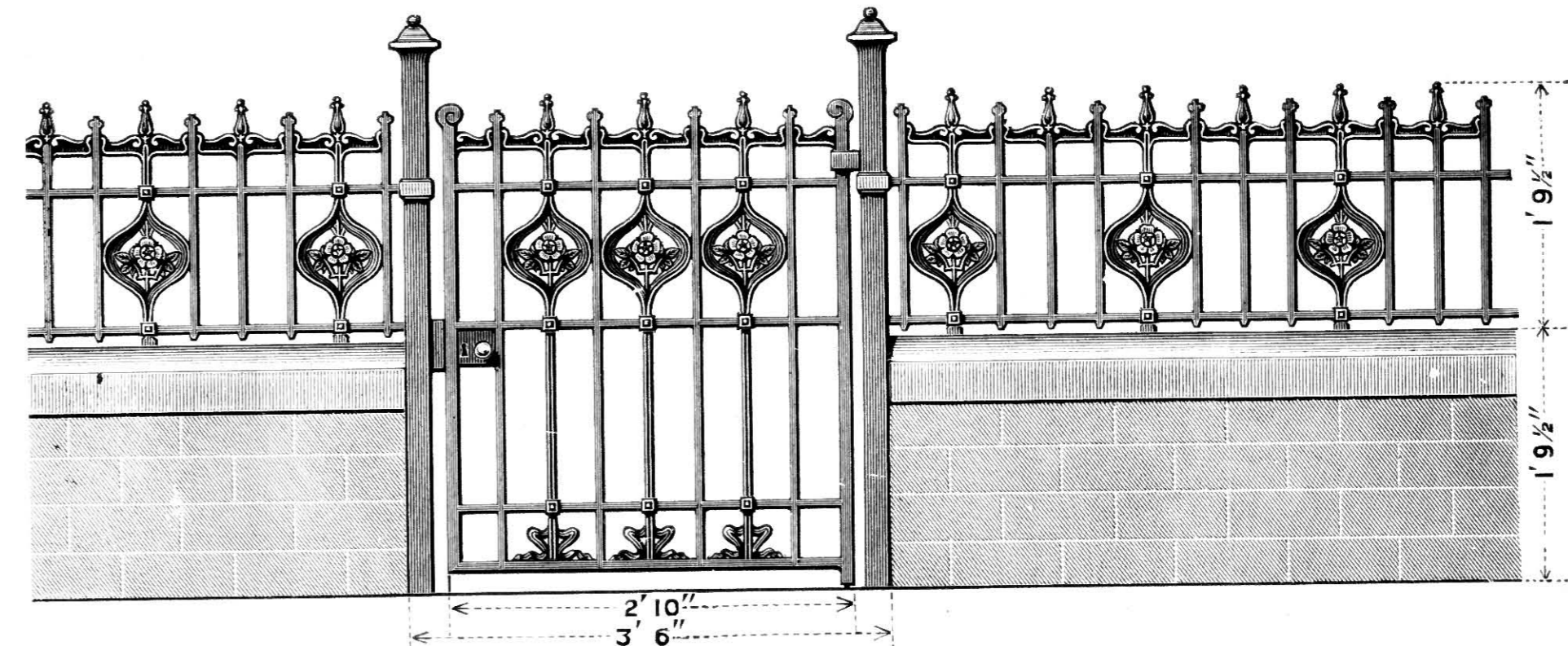

No. 38 Gate, fitted with Lock,	66/- each.
"    "    "    Latch,	45/- "
Gate Standards,	45/- per pair.
Railing, 21 1/2 ins. high,	16/6 per yard.
Railing Standards, Intermediate or Corner, Painted One Coat,	5/6 each.

Cutting and laying out to plan charged extra.



# GATE AND RAILING AND COPING.

No. 201.

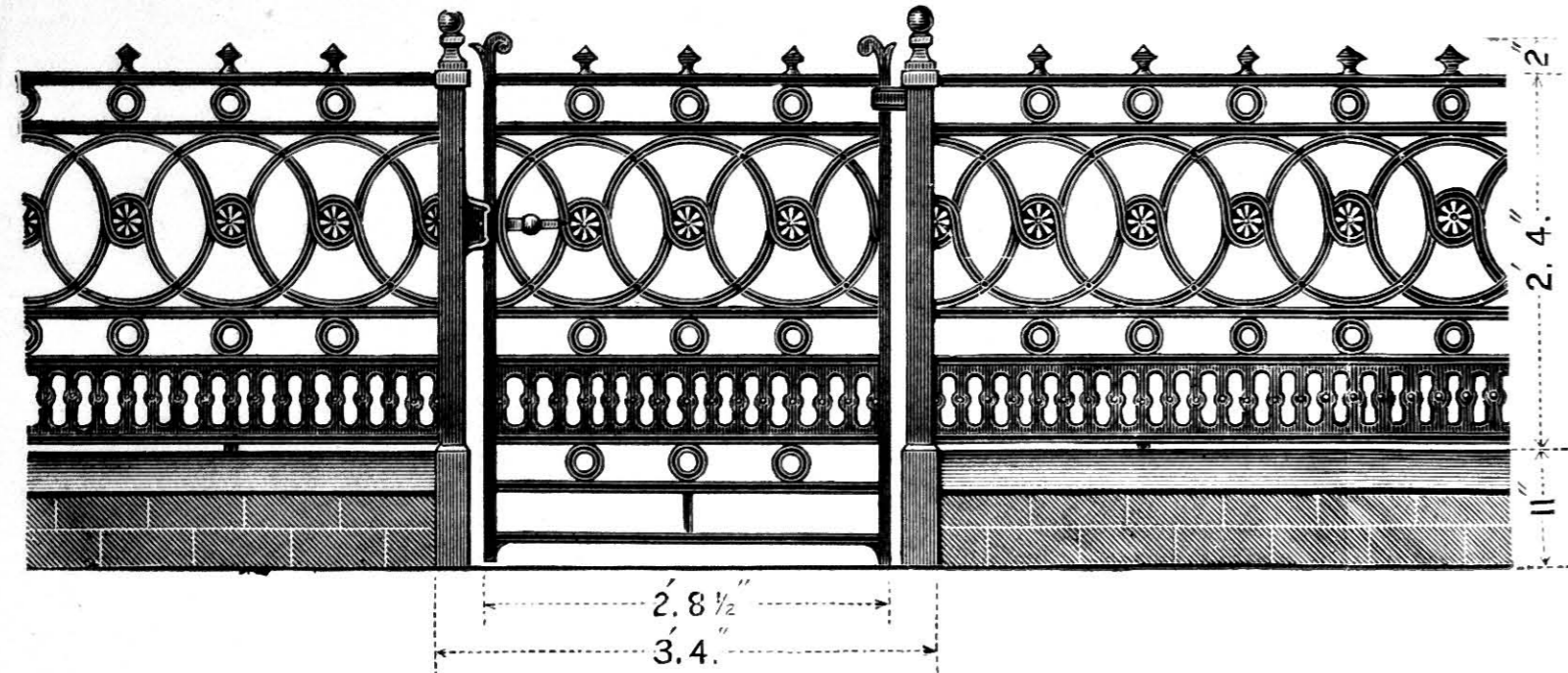

No. 201 Gate, with Lock, ..... 75/- each.  
 " " " Latch, ..... 54/- " "  
 Gate Standards, ..... 30/- per pair.  
 Railing, 30 ins. high, ..... 21/9 per yd.  
 Railing Standards, Intermediate or Corner, ..... 7/6 each.  
 Cutting and laying out to plan charged extra.

No. 1.

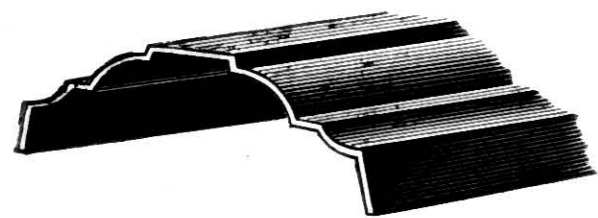

9 ins. wide.  
10/6

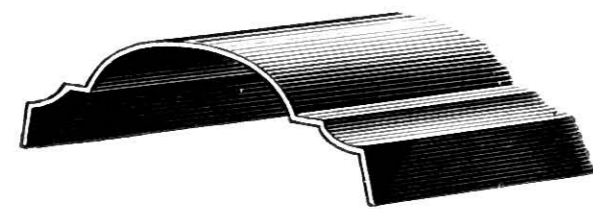

6 ins. wide, 5 ft. lengths. 9 in. wide, 6 ft. lengths.  
9/- 10/- per yd.



Gate Stop.  
5 3/4 x 3 ins.  
3/6 each.

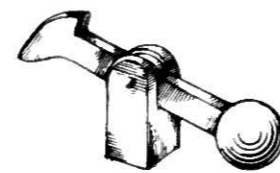

Gate Catch.  
17 ins.  
5/6 each.

No. 10



18 1/2 lbs.

## CROSS RAIL STANDARDS.

No. 3

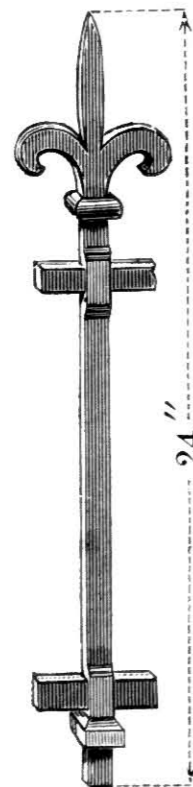

7 lbs.

No. 4



9 lbs.

No. 2



13 lbs.

For Prices of these Standards see next page.

# CROSS RAIL STANDARDS.

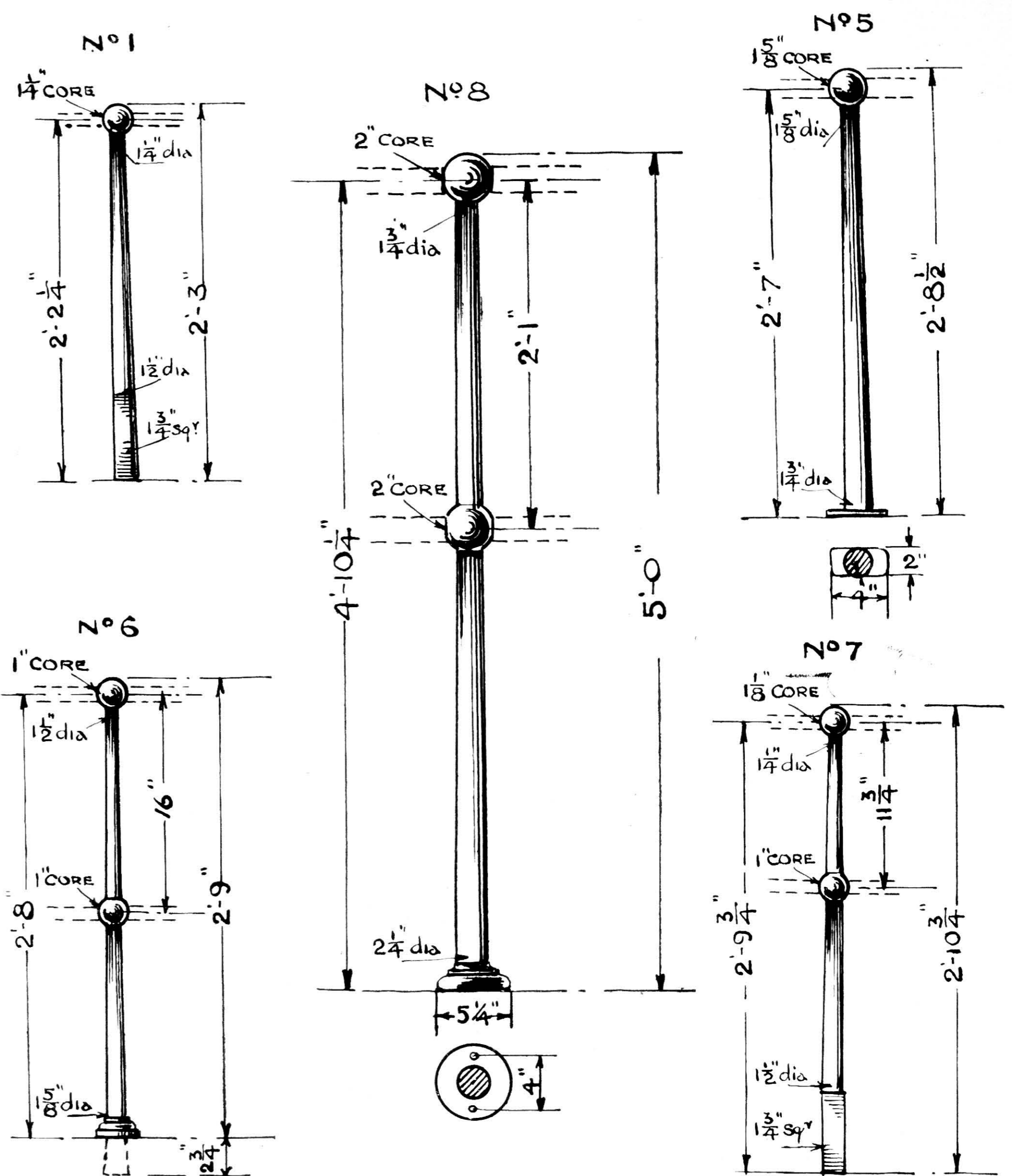









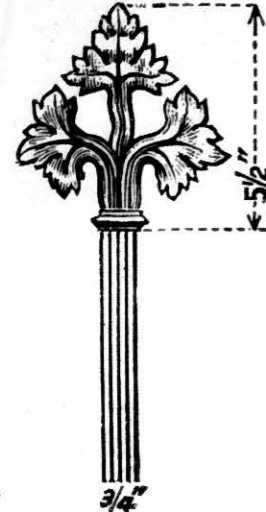
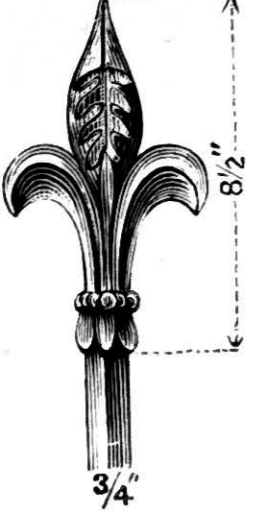
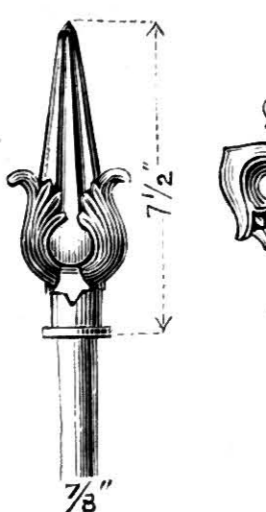

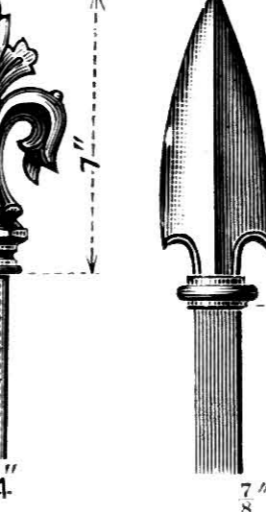
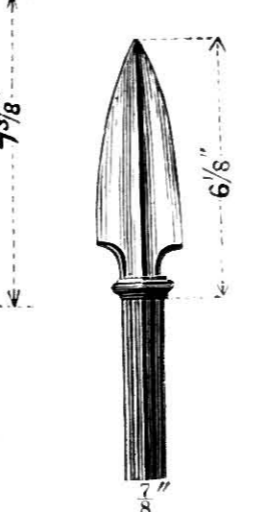
## CROSS RAIL STANDARDS.

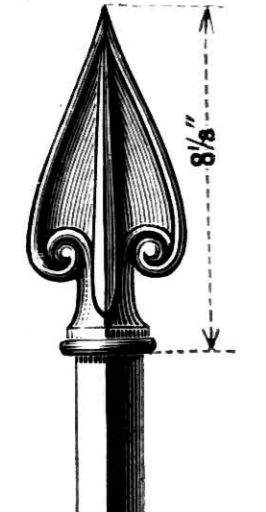
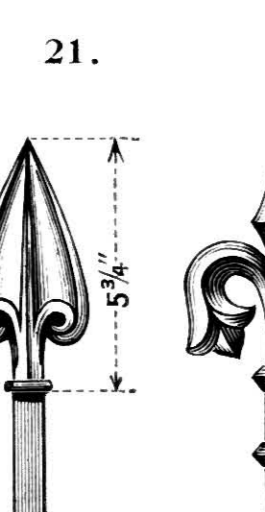
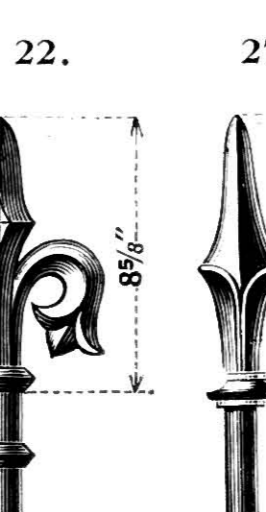

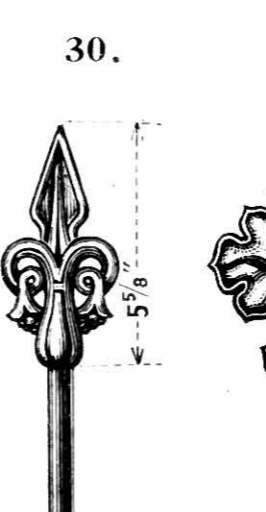
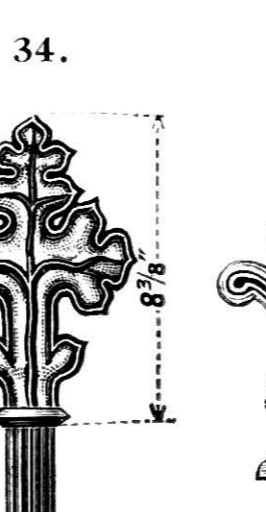

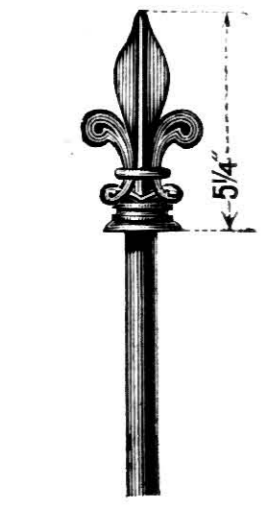
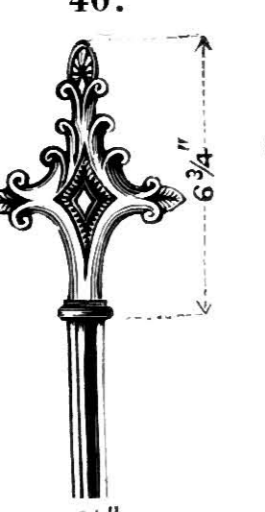
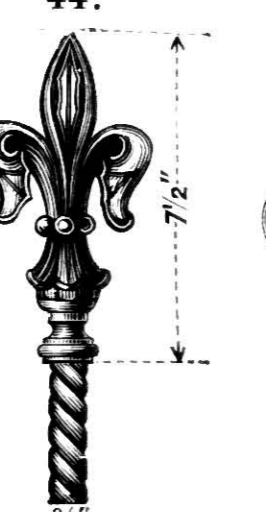
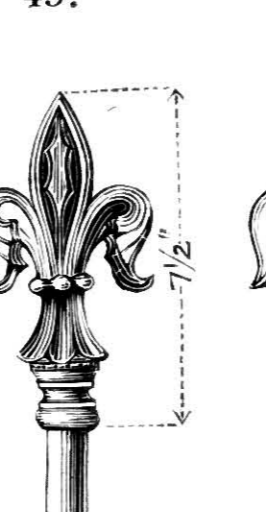
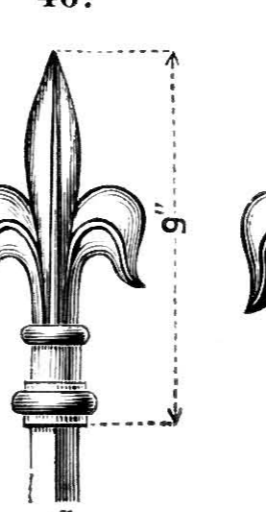
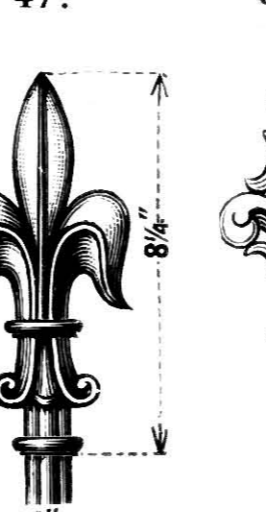

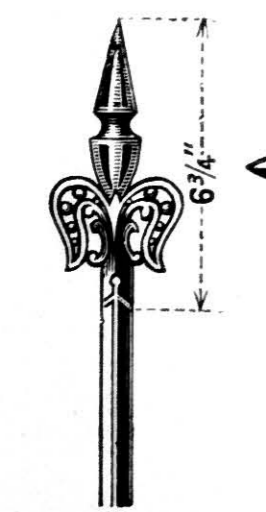
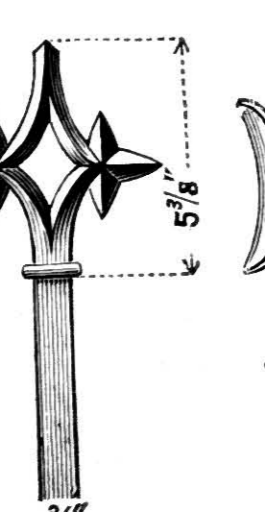
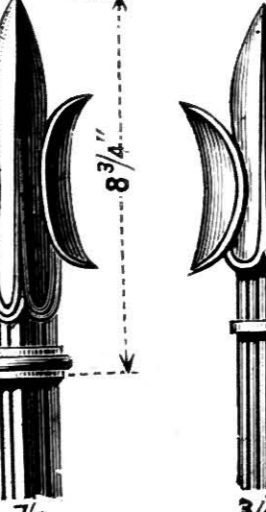
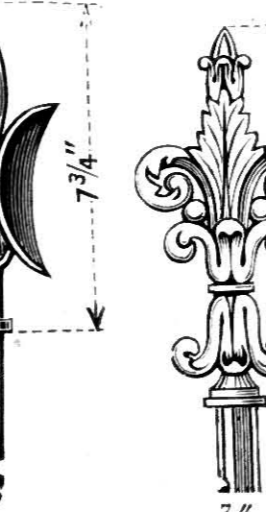
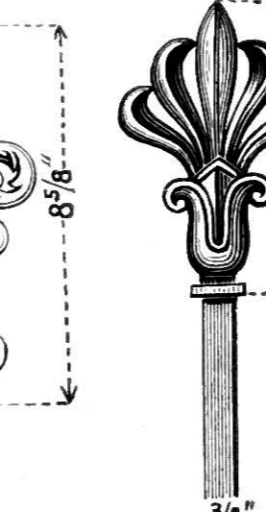
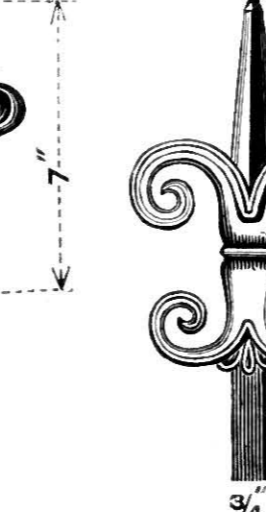
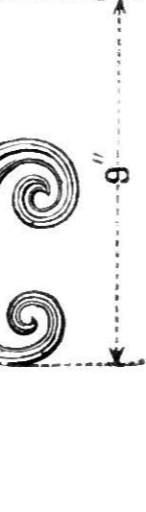

Nos.,	1	2	3	4	5	6	7	8	10	10
Sizes,	27	33	24	24	32 1/2	33	34 3/4	60	36	29 ins. high.
Prices,	5/6	5/6	3/3	4/-	7/-	7/6	7/6	21/-	7/-	5/6 each.

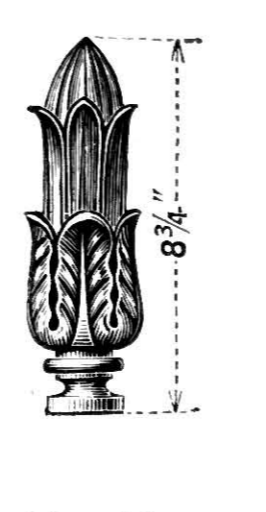
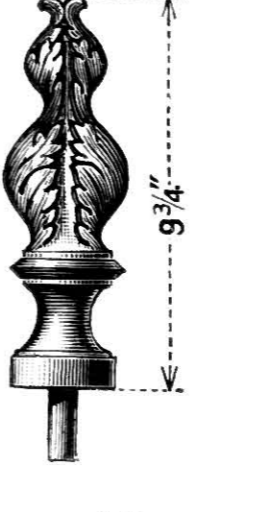

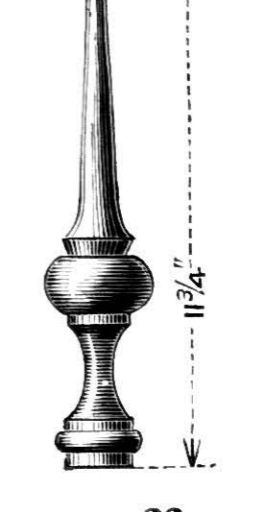
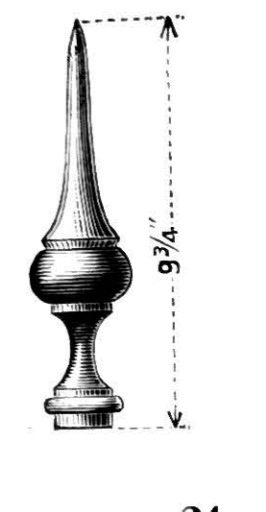

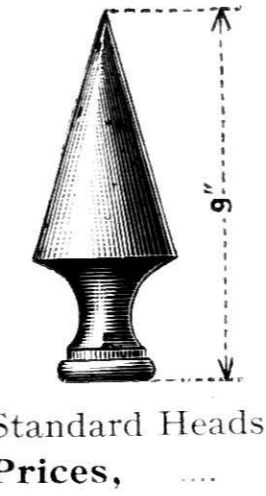
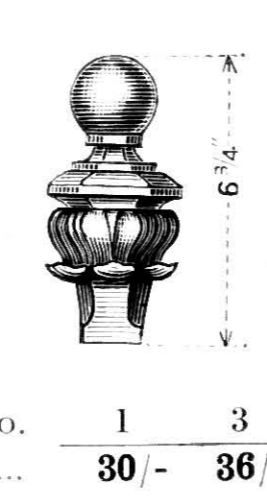

# OUTSIDE BALUSTERS (Made any Length).

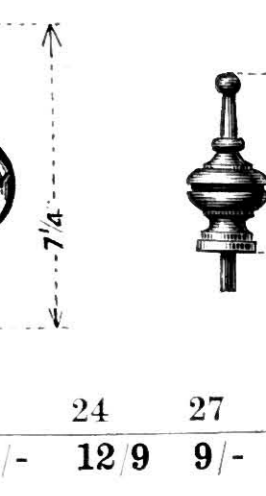
No. 2.	4.	6.	9.	10.	14.	15.	16.
							
Weight (per 3 ft.) about 6 lbs.	8 lbs.	9 lbs.	8½ lbs.	7½ lbs.	10 lbs.	7½ lbs.	6 lbs.
No. 19.	21.	22.	27.	28.	30.	34.	36.
							
Weight (per 3 ft.) about 16 lbs.	6 lbs.	9 lbs.	11 lbs.	10 lbs.	5½ lbs.	14 lbs.	10 lbs.
No. 37.	40.	44.	45.	46.	47.	51.	
							
Weight (per 3 ft.) about 5 lbs.	6½ lbs.	6 lbs.	8 lbs.	12 lbs.	9 lbs.	5½ lbs.	
No. 52.	56.	57.	58.	66.	68.	69.	
							
Weight (per 3 ft.) about 5½ lbs.	9 lbs.	8 lbs.	7 lbs.	7 lbs.	12 lbs.	10 lbs.	
Price, .....							42/- per cwt.

# STANDARD HEADS.

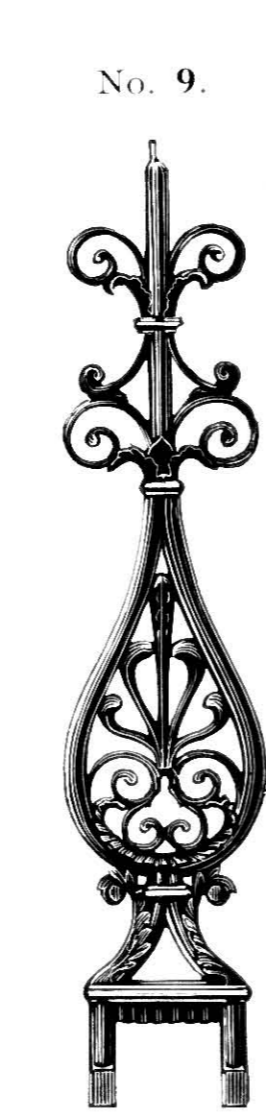
No. 1.	3.	4.	11.	12.	17.							
												
No. 16.	19.	22.	23.	24.	27.							
												
Standard Heads No. ....	1	3	4	11	12	17	16	19	22	23	24	27
Prices, .....	30/-	36/-	33/-	22/6	22/6	21/-	30/-	26/3	16/6	36/-	12/9	9/- per doz.

# STAIR BALUSTERS.

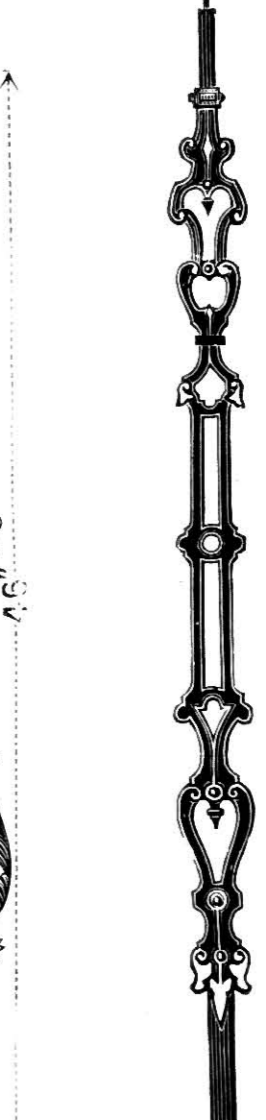
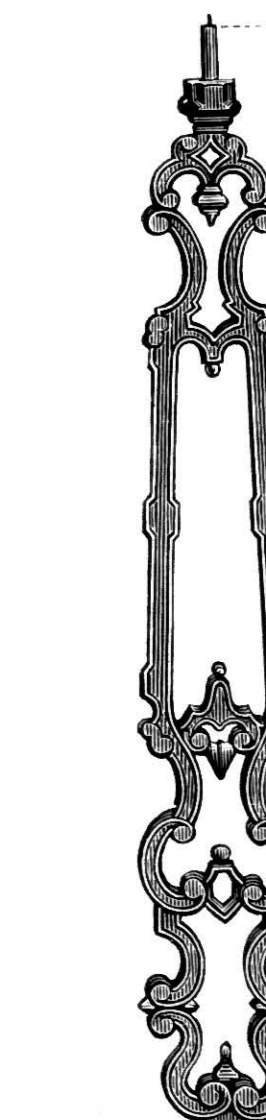
No. 9.	12.	14.	16.	19.	20.						
											
9½ lbs.	14 lbs.	7½ lbs.	9 lbs.	7½ lbs.	12 lbs.						
Nos. ....	9	9	12	14	14	14	16	19	20	20	20
Sizes, .....	29	33	38	35	36	40	46	42½	31	32	34 ins. long.
Prices, .....	45/-	45/-	56/3	34/6	34/6	42/-	54/-	39/-	43/6	45/-	47/3 per doz.



# STAIR BALUSTERS.

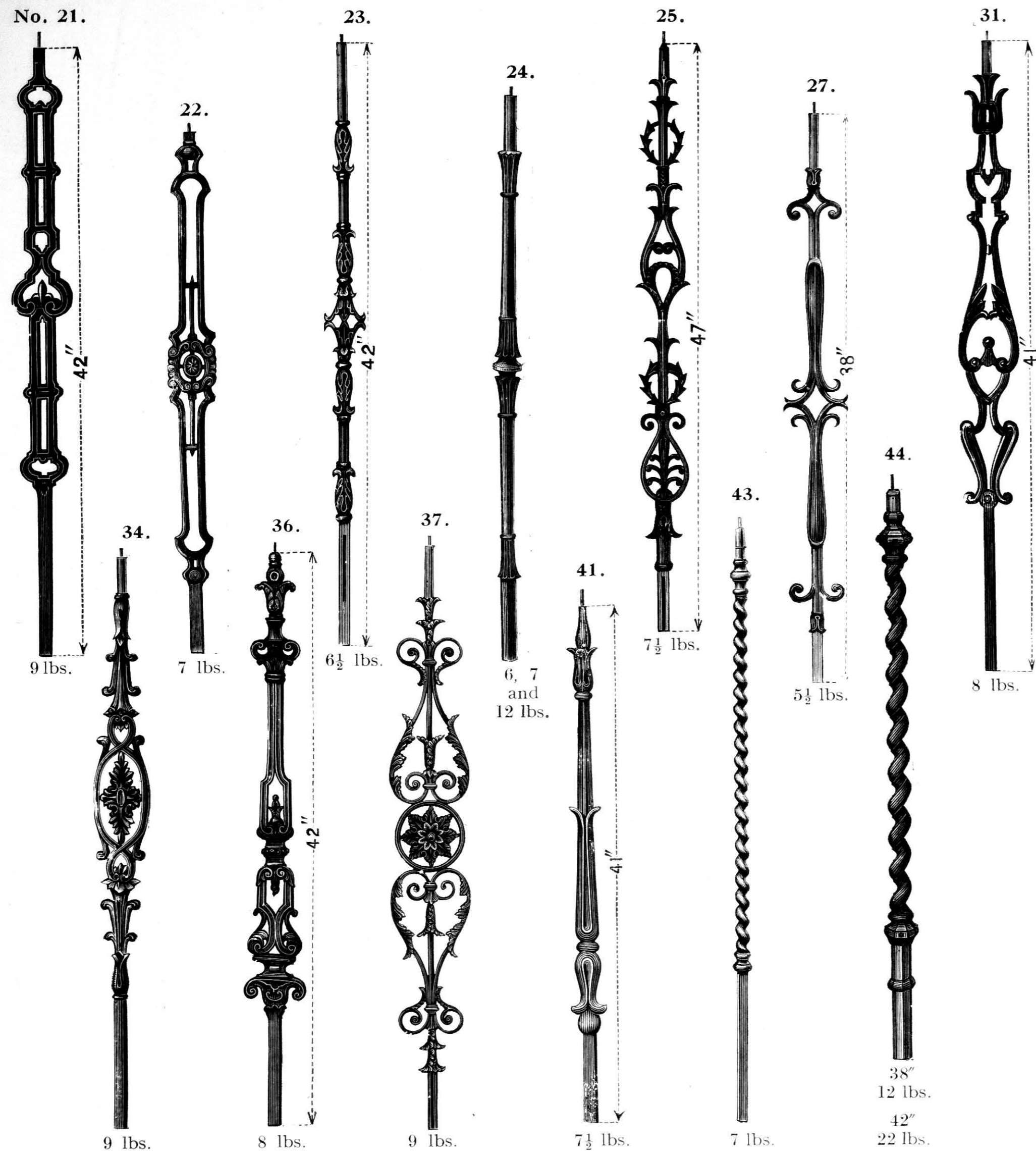

Stair Balusters,	Nos.	21	22	23	24	24	24	25	27	31	31
Lengths,		42	36	42	34	39	45	47	38	41	45 ins.
Prices,		45/-	36/-	36/-	27/-	28/6	45/6	39/-	34/6	43/6	45/- per doz.
	Nos.,		34	36	37	41	43	43	44	44	
Lengths,			41	42	45	41	37 1/4	43	38	42 ins.	
Prices,			45/-	43/6	56/3	36/-	37/6	40/6	45/-	75/- per doz.	

# STAIR BALUSTERS.

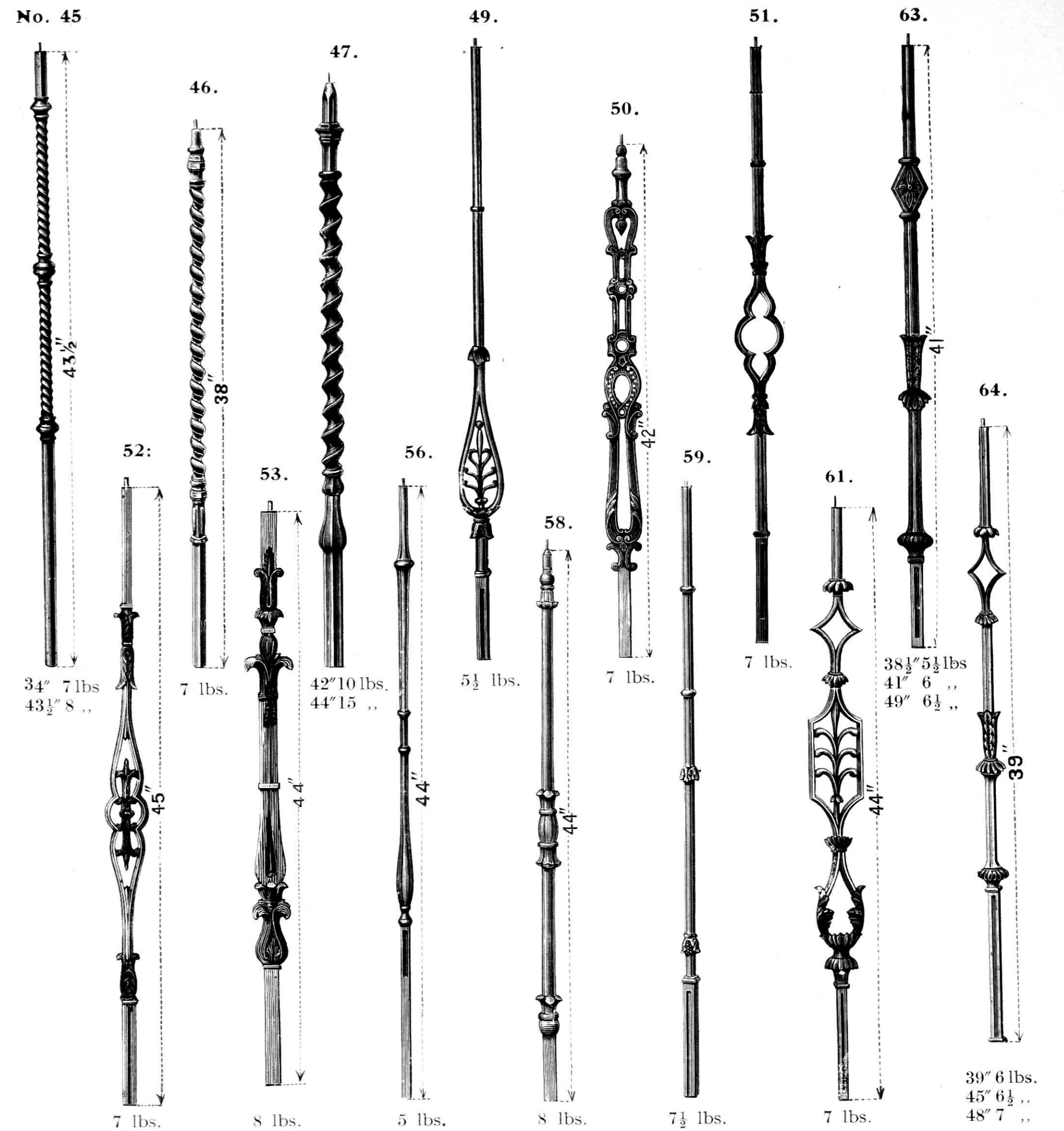

Stair Balusters,	Nos.	45	45	46	47	47	49	50	51	52	53	56
Length,		34	43 1/2	38	42	44	46 1/2	42	50	45	44	44 ins.
Prices,		31/6	40/6	31/6	45/-	56/3	35/3	41/3	39/-	39/-	42/9	30/- per doz.
	Nos.		58	59	61	63	63	63	64	64	64	
Length,			44	48	44	38 1/2	41	49	39	45	48 ins.	
Prices,			40/6	31/6	41/3	28/6	31/6	33/9	35/3	37/6	40/- per doz.	



# MAIN BALUSTERS OR NEWELS.



MAIN BALUSTERS OR NEWELS.										
Nos.,	1	4	5	6	7	7	7	7	7	7
Lengths,	40	34	40	38	32	35	37½	39	ins.	
Prices,	11/3	9/3	9/3	12/9	6/9	9/-	9/-	10/6	each.	
Nos.,	12	12	13	15	16	17	17	18		
Lengths,	43	36	47	45	44	43	46	45	ins.	
Prices,	6/9	6/3	9/-	11/3	12/9	7/6	7/6	9/-	each.	

# CRESTINGS, &c.

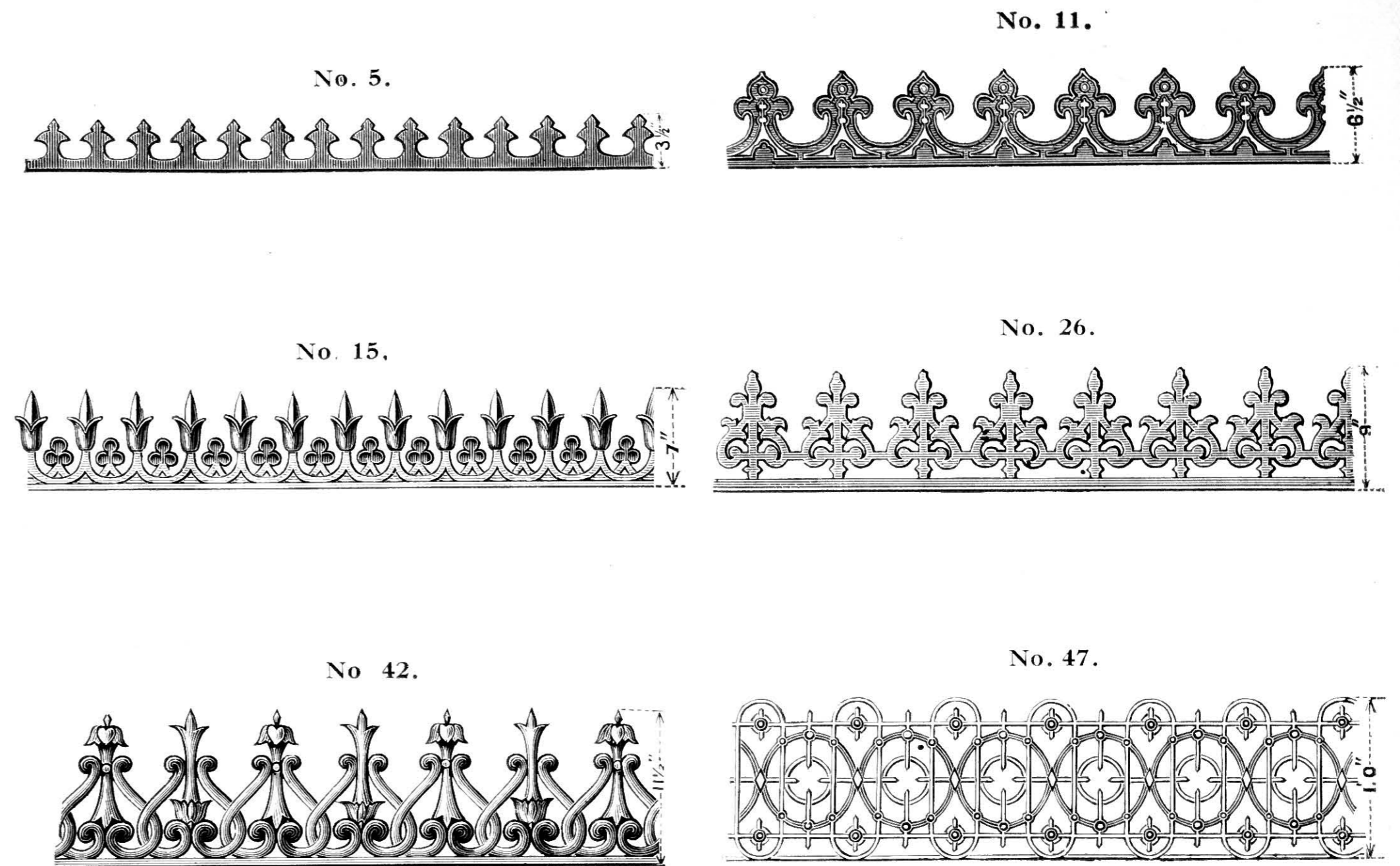

Crestings,	No.	5	11	15	26	42	47
Lengths,		36	48	48	48	51	42 ins.
Prices,		3/3	5/3	7/6	7/6	15/9	13/6 per length

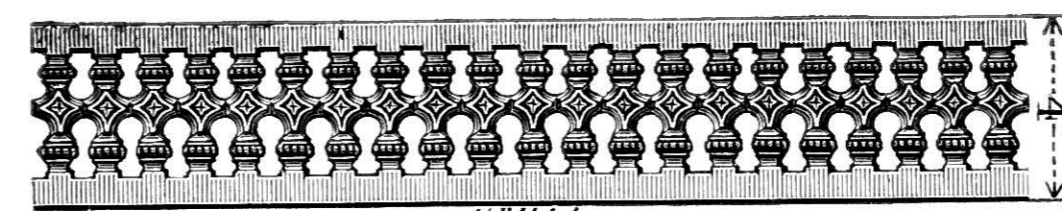

No. 10 STEP RISER.							
Sizes,	36×3	3½	4	4½	5	6	ins.
Prices,	1/3	1/6	1/8	1/9	2/-	2/3	each.
Sizes,	42×3	3½	4	4½	5	6	ins.
Prices,	1/6	1/9	1/9	2/-	2/3	2/6	each.
Sizes,	48×3	3½	4	4½	5	6	ins.
Prices,	1/9	2/-	2/3	2/3	2/6	2/9	each.
Sizes,	54×3	3½	4	4½	5	6	ins.
Prices,	2/-	2/3	2/6	2/6	2/9	3/3	each.
Sizes,				60×3	3½	4	ins.
Price,				2/3	2/9	3/-	each.

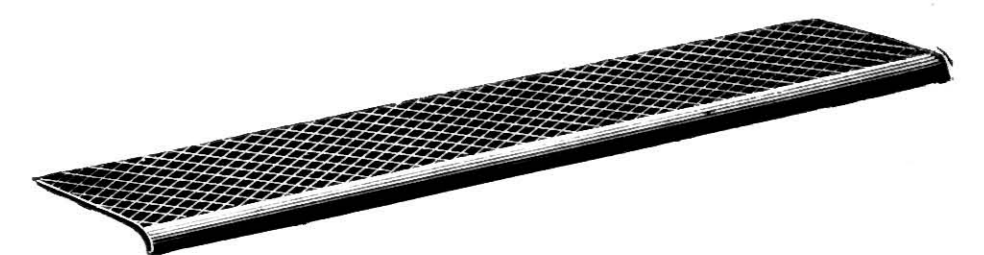

STAIR STEP NOSING—¼ in. thick.					
Sizes,	2×18	3×24	30	3½×26	ins.
Prices,	1/3	2/-	2/3	2/6	each.
Sizes,				3½×36	3½×42
Prices,				3/-	3/3



# FINIALS.

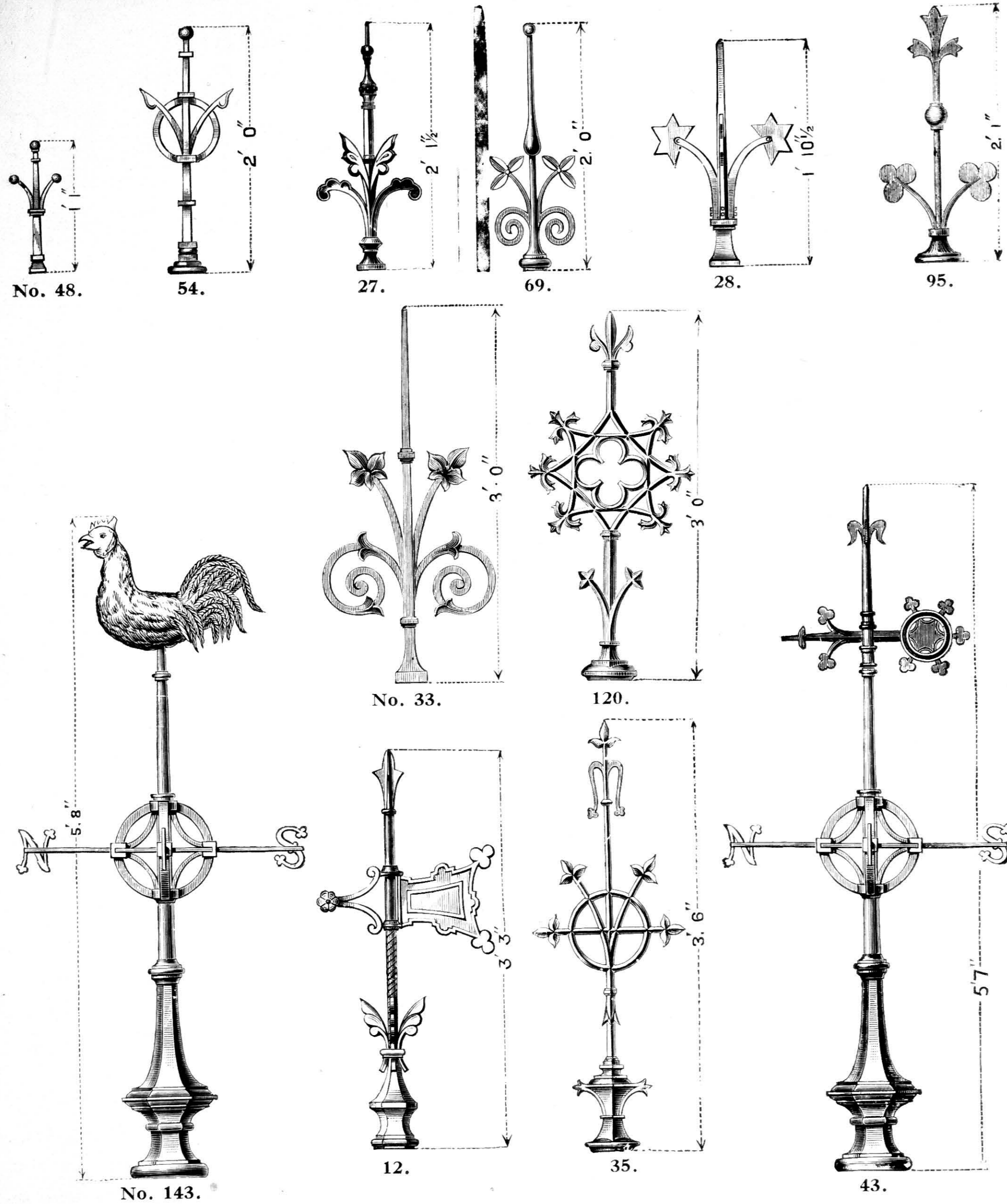

Finials,	.....	No.	48	48	28	69	121	95	95	54	33	120	
Ways,	.....		2	4	4	2	2	2	3	4	4	2	
Prices,	.....		4/6	6/-	17/3	7/6	11/3	10/6	12/-	7/6	22/6	15/-	each.
Finials,	.....						Nos.,	27	143	12	35	43	
Ways,	.....							4	4	2	2	4	
Prices,	.....							13/6	75/-	26/3	18/-	67/6	each.

# TOMB RAILINGS.

No. 100.

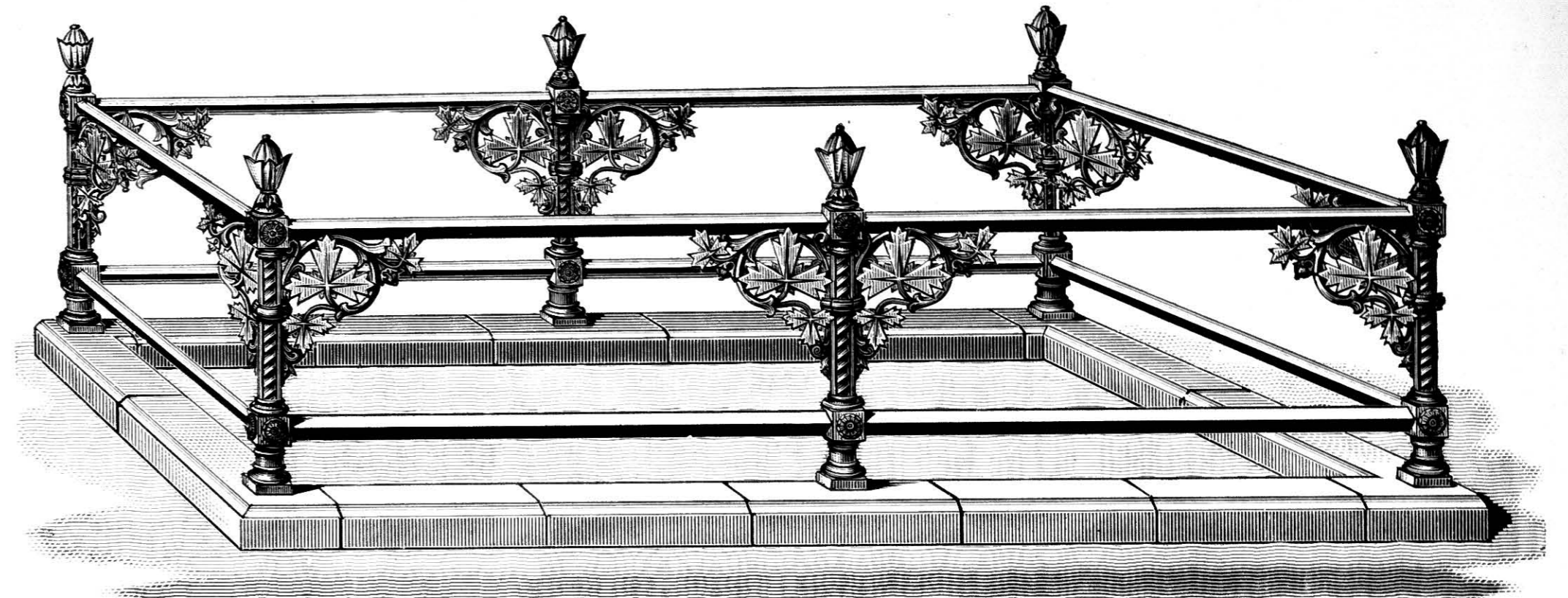

Standards for Corners,	.....	.....	.....	.....	.....	.....	.....	.....	.....	.....	.....	.....	.....	14/3	each.
„ „ Intermediate,	.....	.....	.....	.....	.....	.....	.....	.....	.....	.....	.....	.....	.....	13/6	„
„ „ Ends,	.....	.....	.....	.....	.....	.....	.....	.....	.....	.....	.....	.....	.....	12/-	„
1 in. Wrought-iron Rails, set on angle,	.....	.....	.....	.....	.....	.....	.....	.....	.....	.....	.....	.....	.....	1/3	per foot.

No. 105.

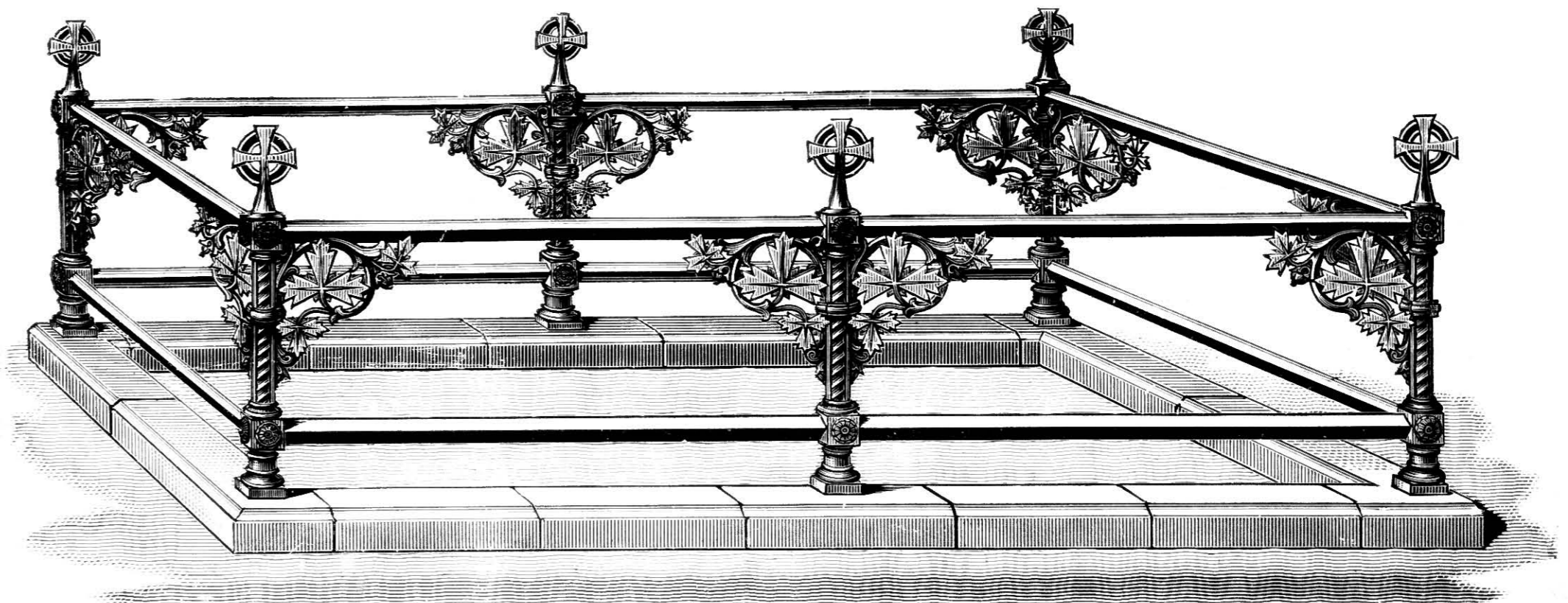

Standards for Corners,	.....	.....	.....	.....	.....	.....	.....	.....	.....	.....	.....	.....	.....	15/-	each.
„ „ Intermediate,	.....	.....	.....	.....	.....	.....	.....	.....	.....	.....	.....	.....	.....	14/3	„
„ „ Ends,	.....	.....	.....	.....	.....	.....	.....	.....	.....	.....	.....	.....	.....	12/9	„
1 in. Wrought-iron Rails, set on angle,	.....	.....	.....	.....	.....	.....	.....	.....	.....	.....	.....	.....	.....	1/3	per foot.



# TOMB PILLARS.

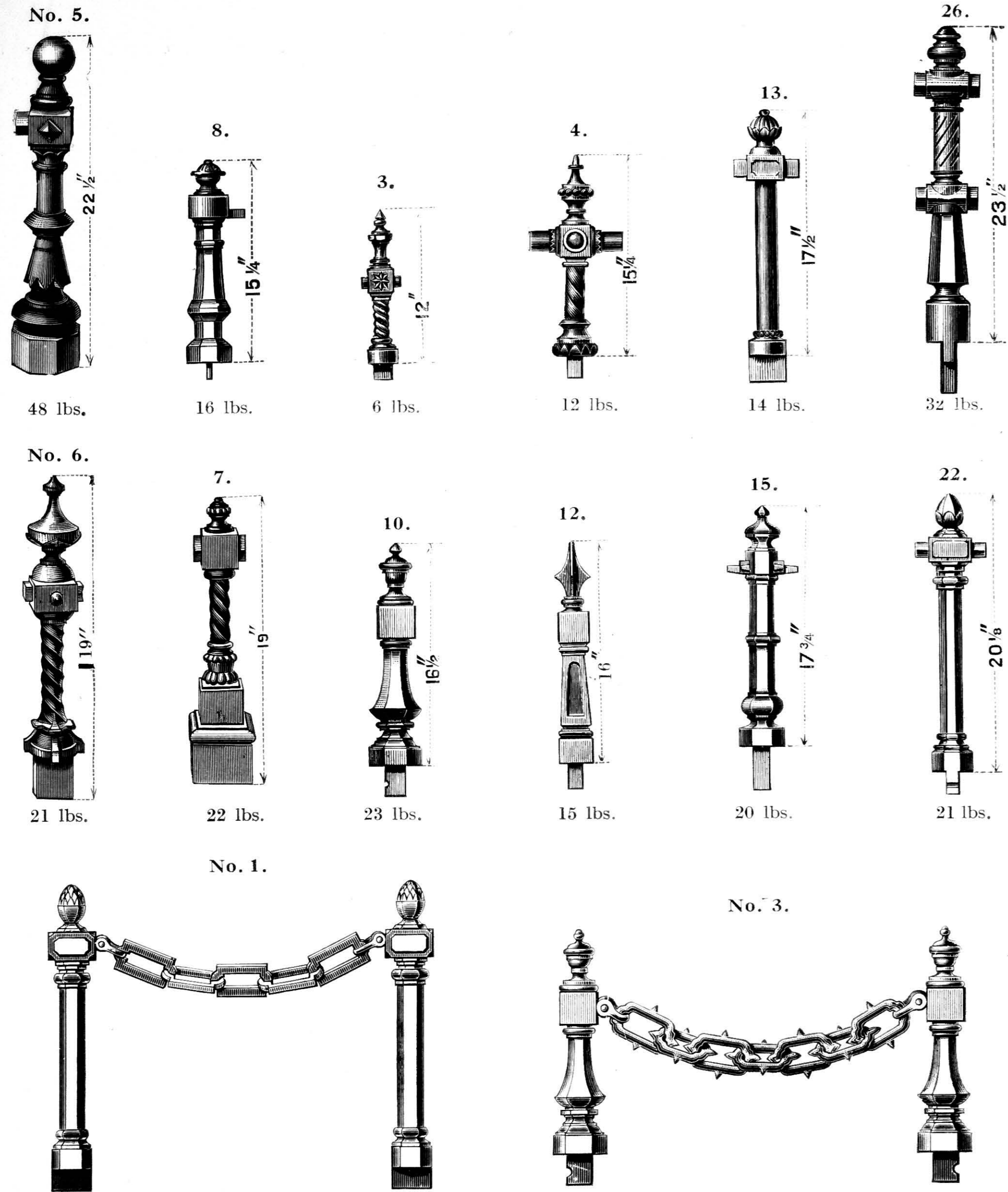

TOMB PILLARS, as shown.

Nos.	3	4	5	6	7	8	10	12	13	15	22	26
Prices,	3/-	4/6	12/-	6/-	7/6	5/3	8/3	5/3	4/9	5/6	6/-	9/9 each
Tomb Chain only,					Nos. 1		3					
Prices,					3/9		4/6		per foot.			

# CANTILEVER BRACKETS, Etc.

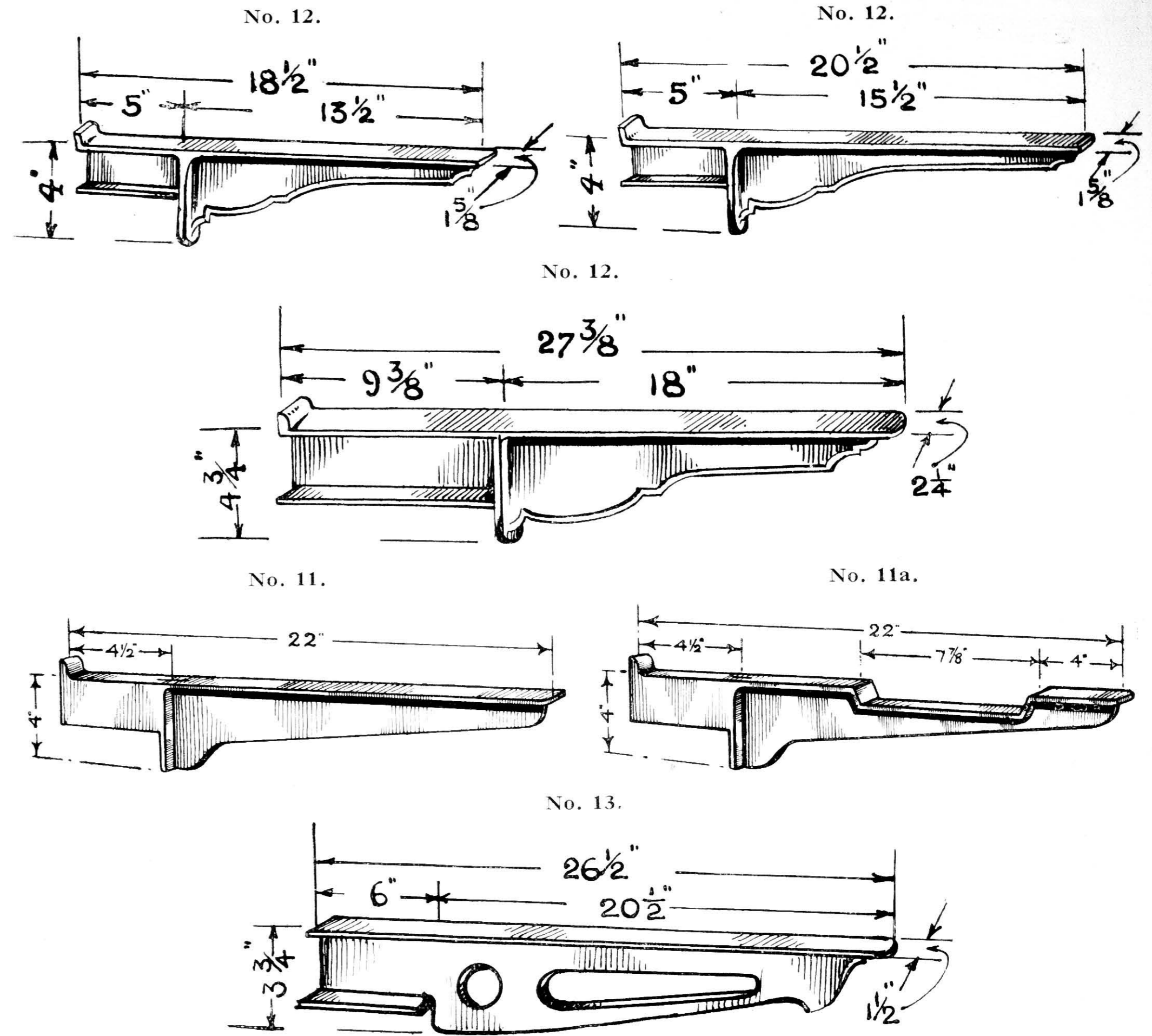

Cantilever Brackets,	Nos. 12	12	12	11	11a	13
Lengths,	18½	20½	27¾	22	22	26½ ins.
Prices,	4 6	4 9	9/-	5 3	5 3	8 6 per pair.

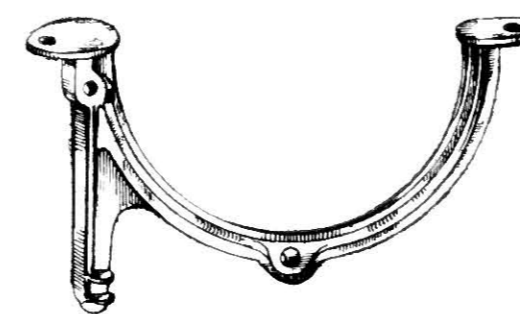

Ashbin Brackets.  
 Sizes, 16 18 20 24 ins.  
 Prices, 6 6 7/6 10/6 12/- per pair.

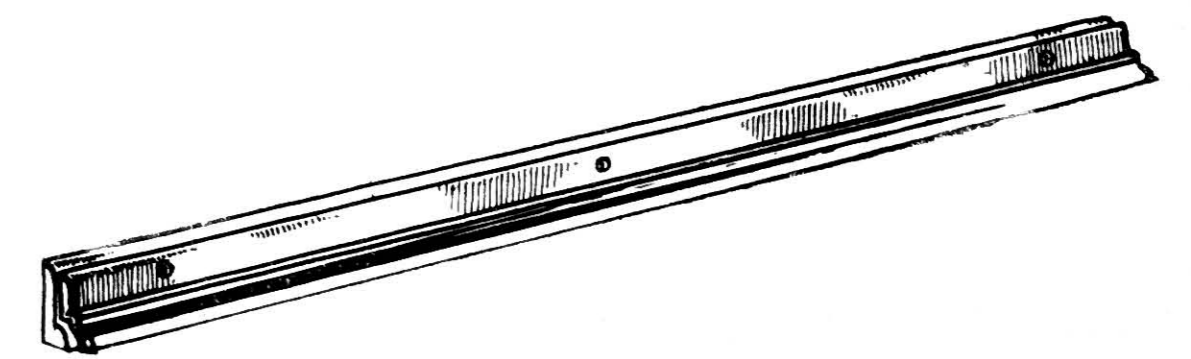

Storm or Water Bars.  
 Lengths, 32 34 36 38 42 ins.  
 Prices, 3/- 3 3 3/6 3 9 4/- per set of 2 pieces.



## SHELF BRACKETS, &c.

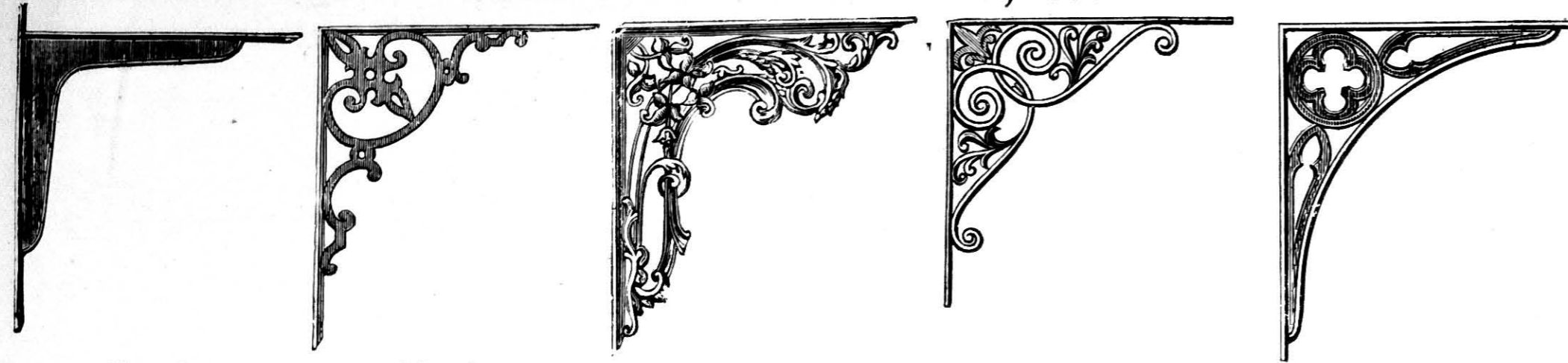

No. 1.	No. 2.		No. 3.				No. 4.				No. 5.				
No. 1, ...	...	...	5x6	6x8	7x9	8x10	9x11	10x12	12x14	12x24	14x16	16x18	18x20 ins.		
Prices, ...	...	...	7/6	9/-	9/9	11/-	12/9	13/6	15/9	33/9	21/-	24/-	25/6 doz.		
No. 2, ...	4x5	5x6	5x7	6x7	6x8	7x8	8x9	8x10	9x9	9x10	10x12	10x18	12x14	14x16	16x18 ins.
Prices, ...	4/9	6/3	6/6	7/-	7/6	8/-	10/9	11/3	12/9	12/9	13/6	21/-	20/3	24/-	26/3 doz.
No. 3, ...	...	...	...	4x5½	5x7	6x8	7x9	8x10	9x10	10x12	12x14	14x14	14x16	16x18 ins.	
Prices, ...	...	...	...	4/9	5/6	7/6	9/-	11/3	12/-	14/3	22/6	24/-	25/6	28/6 doz.	
No. 4, ...	...	...	...	...	...	6x6	7x7	8x8	9x9	10x10	11x11	12x12	14x14 ins.		
Prices, ...	...	...	...	...	...	7/6	8/3	10/6	11/3	13/6	15/9	21/-	27/9 doz.		
No. 5, ...	...	...	...	...	3x4	4x5	5x6	6x7	7x8	8x10	10x12	12x14	14x16 ins.		
Prices, ...	...	...	...	...	2/9	4/-	4/6	5/6	6/9	9/-	13/-	15/9	18/9 doz.		

### PEDESTAL BRACKETS.

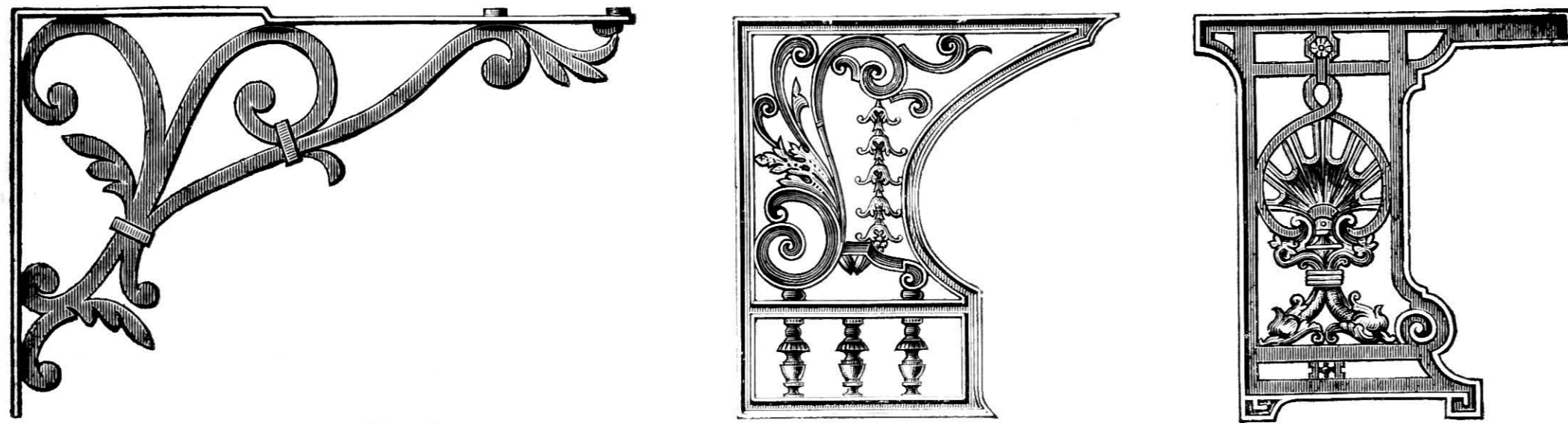

No. 1.	No. 2.	No. 3.
Sizes, ...	10½ x 15½ ins.	16 x 17½ ins.
Prices, ...	4/6	12/-
		15½ x 17½ ins.
		9/9 pair.

### CAST-IRON NUMBER PLATES—with Numbers cast on.

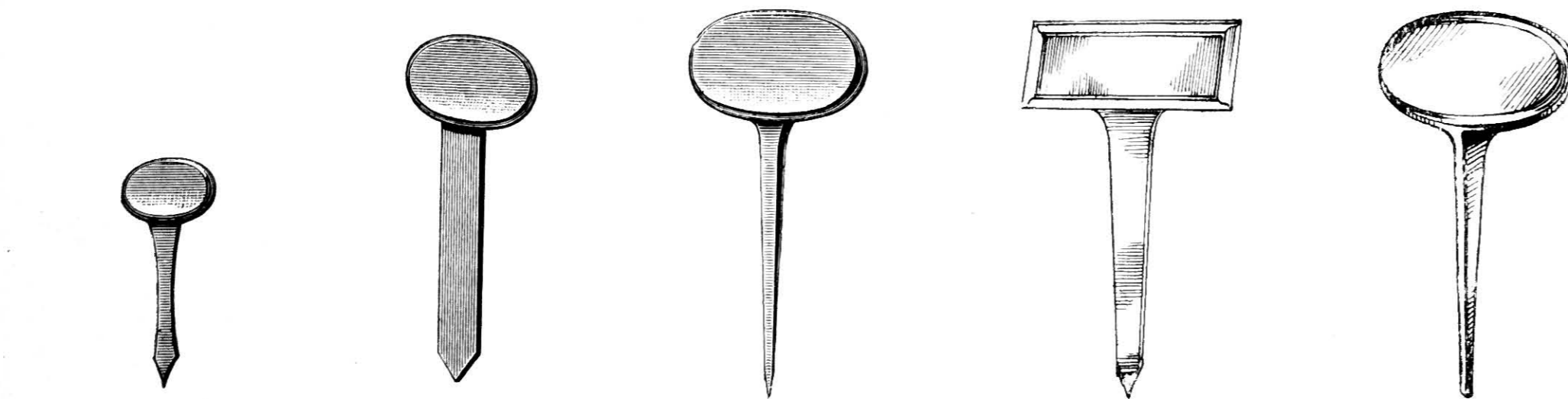

No. 1.	No. 2.	No. 3.	No. 4.	No. 5.
Sizes, ...	3½	5½	5¾	6 x 3 ins.
Prices, ...	7/-	10/-	18/-	10/-
				24 ins.
				27/- doz.

### POULTRY TROUGH.

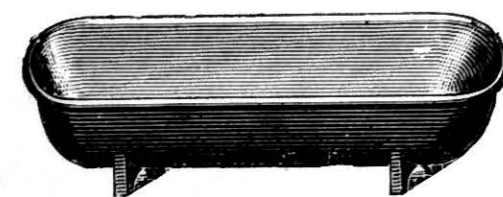

Size, ...	12	18	24 ins.
Prices, ...	3/3	5/-	6/9 each.

## ORNAMENTAL GRATINGS.

No. 20.

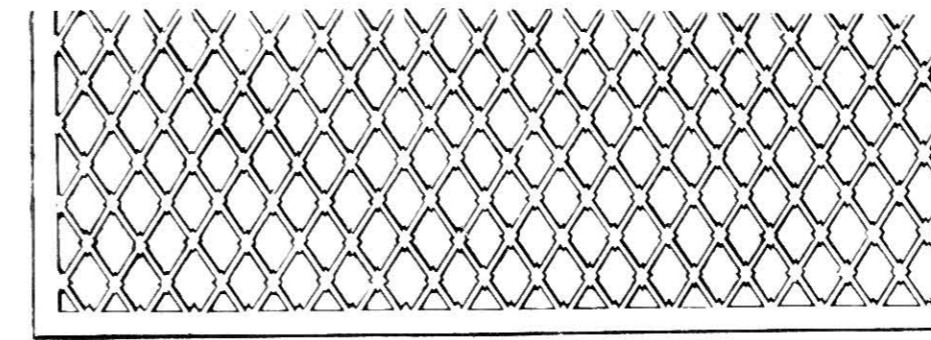

¾" mesh. ½" thick.

Sizes, ...	4x8	6x6	6x12	6x18	6x24	6x36	7x36 ins.	
Prices, ...	9d.	1/-	1/9	2/6	3/9	4/6	5/- each.	
Sizes, ...	8x8	8x34	9x9	9x36	10x10	11x11 ins.		
Prices, ...	1/6	6/-	1/9	6/9	2/3	2/9 each.		
Sizes, ...	11x26	12x24	12x36	12x48	13x13	13x36 ins.		
Prices, ...	5/3	6/-	9/-	11/6	3/6	9/3 each.		
Sizes, ...	14x18	18x24	18x26	18x36	19x36	24x36	24x48	36x36 ins.
Prices, ...	4/6	9/-	9/-	12/9	14/-	16/-	21/9	24/- each.

No. 22.

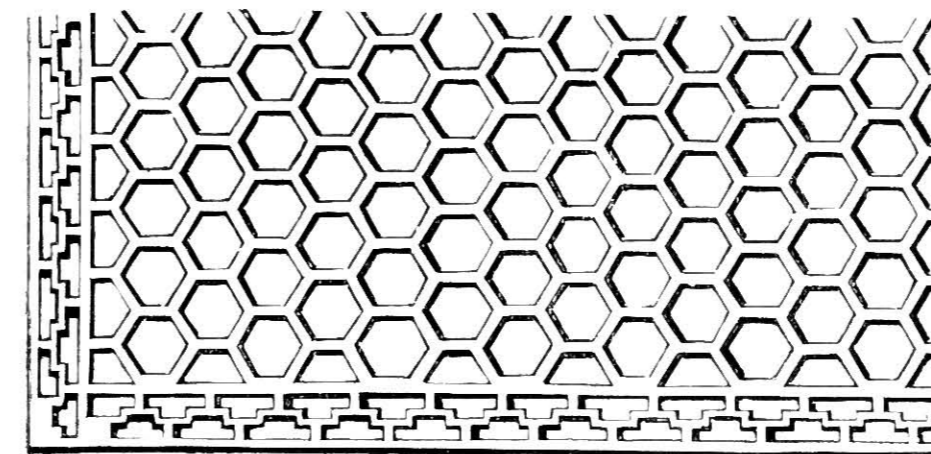

1 3/8" mesh. 3/8" thick.

Sizes, ...	6x9	8x12	9x12	10x10	10x15	12x12	12x18 ins.
Prices, ...	1/6	2/-	2/3	2/6	2/9	2/9	4/- each.
Sizes, ...	16x33	18x24	18x36	20x36	21x36	24x36 ins.	
Prices, ...	8/3	7/6	10/6	10/6	10/6	12/- each.	

No. 24.

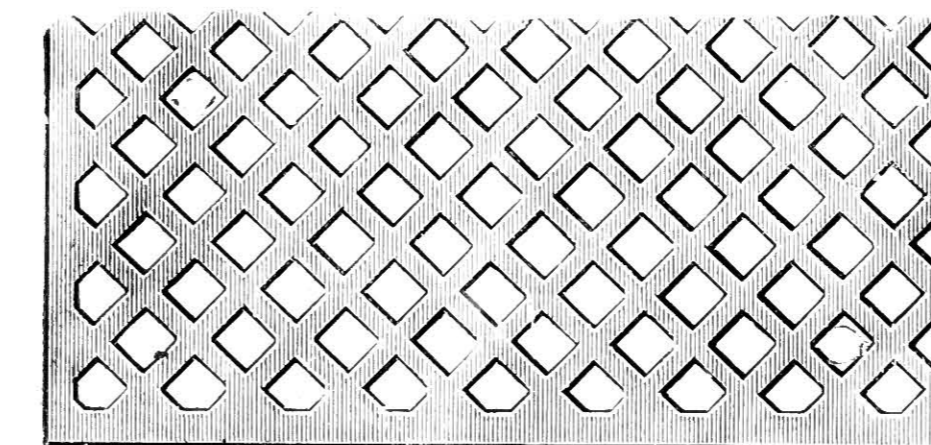

Sizes, ...	6x36	12x48	18x48	20x25½	24x36 ins.
Mesh, ...	1½	1½	1½	1½	1½ "
Thickness, ...	¾	¾	1	¾	¾ "
Prices, ...	8/-	21/-	27/-	18/-	25/- each.

No. 21.

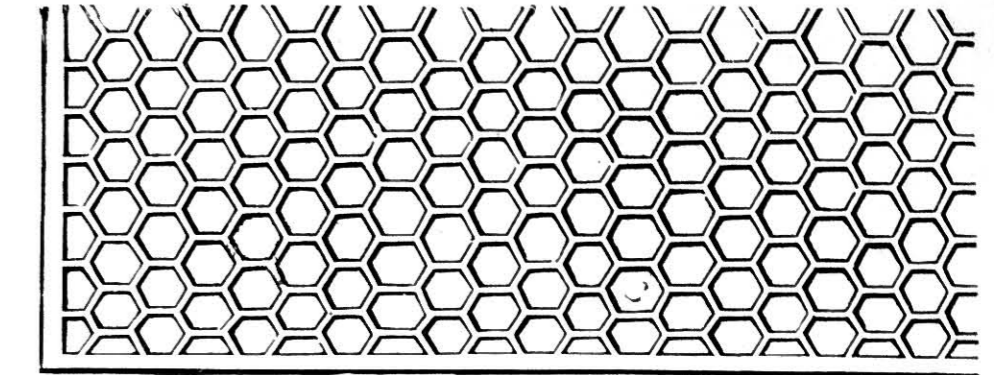

Sizes, ...	12x12	14x27½	18x18x½ in. thick.
Mesh, ...	1½	1½	1½ ins.

Prices, ...	2/6	6/-	5/6 each.
Sizes, ...	21x38	23x46x½	24x24x¾ in. thick.
Mesh, ...	¾	¾	¾ in.

Prices, ...	15/9	19/6	15/9 each.
-------------	------	------	------------

No. 23.

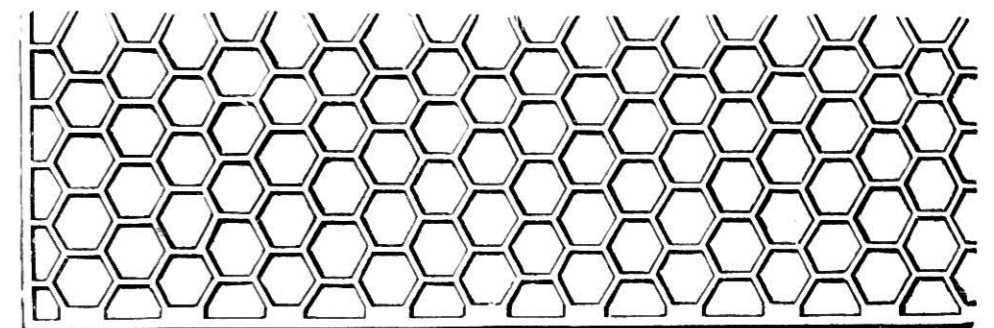

1 1/8" mesh. 1" thick.

Sizes, ...	12x38½	17½x38	18x51	24x36 ins.
Prices, ...	15/9	21/-	27/-	27/- each.

No. 25 (L.S.B.)

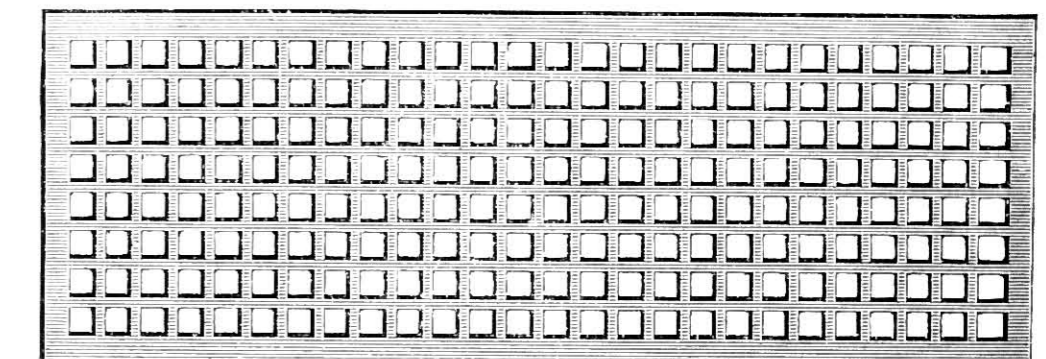

Sizes, ...	5½x48	9x36	11½x18	12x36	12x36 ins.
Mesh, ...	1	1	1	1	1 "
Thickness, ...	1	1	1	1	1 "

Prices, ...	9/9	9/9	6/-	9/9	11/3 each.
Sizes, ...	14x24	24x24	24x30	24x36	36x36 ins.
Mesh, ...	1	1	1	1	1 "
Thickness, ...	1	1	1	1	1 "

Prices, ...	9/6	14/3	21/-	22/6	48/- each.
-------------	-----	------	------	------	------------

### No. 3.—AIR GRATING.

¾ in. thick, ¾ in. mesh. Square Hole.

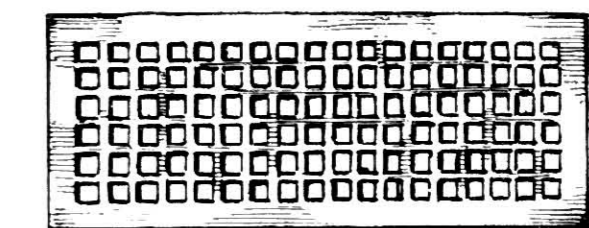

Sizes, ...	3x9	6x9	6x12	6x15	6x18	6x21	6x24 ins.
------------	-----	-----	------	------	------	------	-----------

Fine Cast, ...	6/9	12/-	14/3	17/3	20/6	30/-	31/6 doz.
Galvanized, ...	12/-	22/6	25/-	30/-	37/6	54/-	55/6 "
Sizes, ...	6x30	8x14	10x10	10x15	12x15	17½x17½ ins.	

Fine Cast, ...	40/6	23/3	22/6	33/-	39/-	48/- doz.
Galvanized, ...	64/6	40/6	42/9	57/-	69/-	84/- "







# DRAIN AND GULLY GRATES.

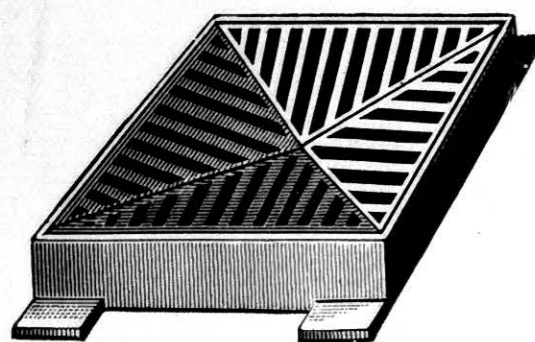

**GARDEN GRATE AND FRAME.**

Sizes, ...	4x4	6x6	7x7	8x8 ins.
Prices,	1/9	2/3	3/-	3/6 each.
Sizes, ...	...	...	9x9	10x10 ins.
Prices,	...	...	4/-	4/9 each.

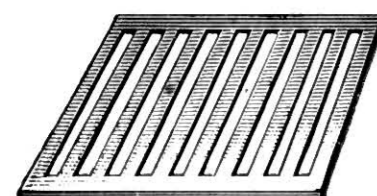

**No. 1 DRAIN GRATE.**

**Flat.**

With and Without Rebate.

No Rebate.						
Sizes, ...	4	4 1/2	4 1/2	5	6	6 ins.
Thickness,	1/2	3/8	1/2	1/2	1/2	3/8
Prices,	6/3	7/-	7/3	8/3	9/9	9/- doz.
Sizes, ...	7	8	8	9	9	10 ins.
Thickness,	1/2	1/2	3/8	3/8	3/8	1/2
Prices,	13/6	18/-	24/-	22/6	30/-	24/- doz.

**Square.**

Sizes, ...	10	10	4 1/2 x 9	6 x 7	7 x 8 ins.	
Thickness,	3/8	3/4	1/2	5/16	1/2	
Prices,	31/6	34/6	11/3	8/3	15/- doz.	
With Rebate.						
Sizes, ...	4	5	6	7	7	8 ins.
Thickness,	3/8	3/8	3/8	3/8	3/8	3/8
Prices,	4/6	6/9	7/9	9/3	12/3	12/- doz.
Sizes, ...	9	10	11	11	12 ins.	
Thickness,	3/8	3/8	3/8	3/8	1/2	
Prices,	15/-	19/6	21/9	36/-	30/- doz.	

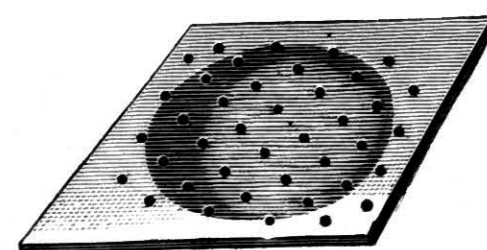

**No. 5 DRAIN GRATE.**

**Dished. Square.**

1/4 in. thick.

Sizes, ...	6	7	8	9	10 1/2 ins.
Prices,	7/6	9/-	12/9	21/-	27/- doz.

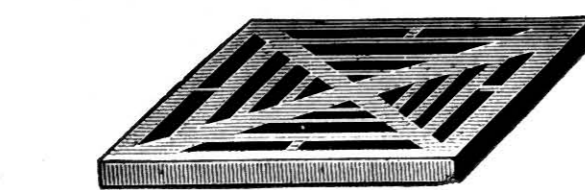

**No. 4 DRAIN GRATE.**

**Flat or Dished.**

**Flat.**

Sizes, ...	4	5	6	6	7 ins.
Thickness,	1/2	3/8	1/2	3/8	3/8
Prices,	6/-	11/-	11/6	13/6	17/- doz.

Sizes, ...	7	8	9	10	12 ins.
Thickness,	1/2	3/8	3/8	3/8	3/8
Prices,	16/6	22/6	25/6	33/-	48/- doz.

**Dished.**

Sizes, ...	4	5	5	6	6	6 1/2	7	7	7 ins.
Thickness,	1/2	3/8	3/8	1/2	1/2	3/8	3/8	3/8	3/8
Prices,	6/9	7/3	11/-	12/9	17/3	11/6	14/3	21/9	21/9 doz.

Sizes, ...	8	8	8	9	9	10	10	12 ins.
Thickness,	3/8	1/2	3/4	1/2	3/4	1/2	3/4	1/2
Prices,	19/6	21/6	24/-	24/-	27/-	31/6	42/-	45/- doz.

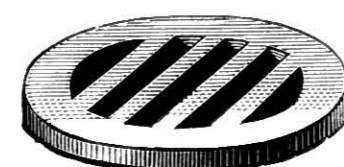

**No. 2 DRAIN GRATES.**

**Flat.**

Diameter,	3	4	4 1/2	5	5	5 1/2 ins.
Thickness,	3/8	3/8	3/8	3/8	1/2	3/8
Prices,	3/-	3/9	5/3	6/-	7/-	6/6 doz.

Diameter,	6	6	6 1/2	6 1/2	7	7	7 ins.
Thickness,	3/8	1/2	3/8	3/8	3/8	3/8	3/8
Prices,	7/6	9/-	10/-	11/-	8/6	13/-	doz.

Diameter,	7 1/2	8	8	8 1/2	9	10 ins.
Thickness,	3/8	3/8	3/8	3/8	1/2	1/2
Prices,	10/6	15/-	18/-	16/6	19/6	23/3 doz.

Diameter,	11	12	12	14 ins.
Thickness,	3/8	1/2	1	1/2
Prices,	21/9	33/9	57/-	45/- doz.

**Dished.**

Diameter,	4 1/2	5	5	5 1/2	5 1/2	6 ins.
Thickness,	3/8	3/8	3/8	3/8	3/8	3/8
Prices,	5/3	5/6	7/-	6/6	9/-	7/6 doz.

Diameter,	6	6 1/2	6 1/2	7	7	8 ins.
Thickness,	3/8	3/8	1/2	3/8	1/2	3/8
Prices,	12/-	8/-	12/-	8/6	13/6	12/9 doz.

Diameter,	8	9	9	9	10	10 ins.
Thickness,	1/2	3/8	3/8	3/8	3/8	1/2
Prices,	19/6	15/9	21/-	24/-	21/-	26/3 doz.

**Dished—with Rebate.**

3/8 in. thick.

Sizes, ...	...	...	6 3/8	7 ins.
Prices,	...	...	11/3	12/9 doz.

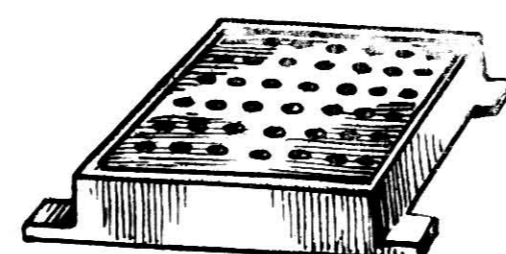

**DRAIN GRATE AND FRAME.**

Sizes, ...	6x6	7x7	8x8	9x9	12x12 ins.
Prices,	2/3	3/-	3/6	4/-	9/- each.

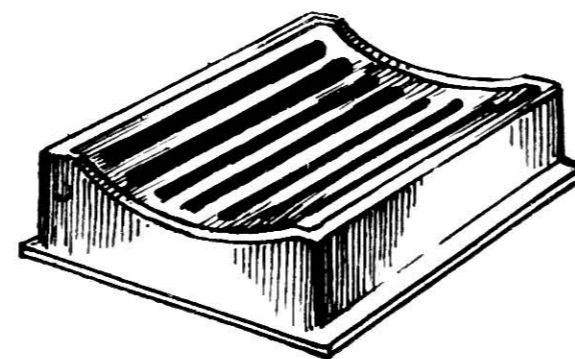

**CHANNEL GRATE AND FRAME.**

**Hinged Cover.**

Sizes, ...	7x7	8x8	9x9	10x10	12x12 ins.
Prices,	5/-	5/6	6/6	8/-	10/6 each.

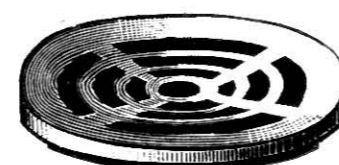

**No. 6 DRAIN GRATE.**

Diameter,	4	5	5 1/2	6	6 1/2 ins.
Thickness,	3/8	3/8	3/8	3/8	3/8
Prices,	4/-	5/6	6/-	7/6	9/9 doz.

Diameter,	7 1/2	10	11	14 ins.
Thickness,	3/8	1/2	1/2	1/2
Prices,	11/6	25/6	30/-	45/- doz.

**No. 6 DRAIN GRATE—with Rebate.**

3/8 in. thick.

Sizes, ...	...	...	8	9 ins.
Prices,	...	...	12/-	13/- doz.



**No. 7 PERFORATED DRAIN GRATES.**

**Flat.**

**Round and Square.**

Round.									
Sizes, ...	2 1/2	3	3 1/2	4	5	6	7 1/2	10 ins.	
Thickness,	3/8	3/8	3/8	3/8	3/8	3/8	3/8	1/2	
Prices,	2/3	3/3	4/9	5/3	7/6	9/-	21/-	35/- doz.	

Square.									
Sizes, ...	6x6	6x6	6x7	7x7	8x8	8x8	8x8 ins.		
Thickness,	3/8	1/2	3/8	3/8	1/2	1/2	1/2		
Prices,	10/6	12/9	13/6	17/3	15/-	22/6	doz.		

Sizes, ...	9x9	9x9	10x10	10x10	12x12 ins.
Thickness,	3/8	1/2	1/4	1/2	1/2
Prices,	21/9	27/-	26/3	40/6	54/- doz.

**ROUND DISHED PATTERN No. 8—Perforated**

6 ins. diameter, 1/4 in. thick.  
12/- per doz.

# ASH GRATES AND FRAMES.

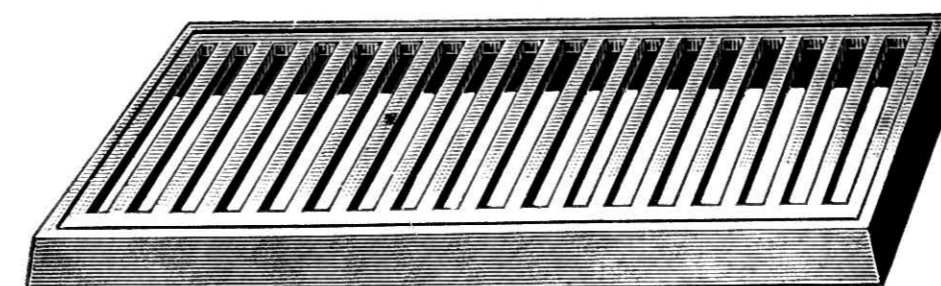

**ASH GRATE AND FRAME.**

1 1/2 ins. high.	Grating, 1 1/4 ins. thick.			
Sizes over Grating, ...	12 1/2 x 23	12 1/2 x 29	12 1/2 x 32	12 1/2 x 35 ins.
Frame, ...	14 x 24	14 x 30	14 x 33	14 x 36
Prices, ...	18/-	21/9	24/-	27/- per set.



**ASH GRATES ONLY—3/8 in. thick.**

Sizes, ...	10x12	10x14	12x12	12x14	12x15	12x16	12x18 ins.	
Prices,	33/-	36/-	39/-	45/-	48/-	48/-	51/- doz.	
Sizes, ...	13x18	14x14	14x16	14x18	14x20	15x18	15x22	20x22 ins.
Prices,	54/-	48/-	54/-	60/-	63/-	66/-	75/-	105/- doz.

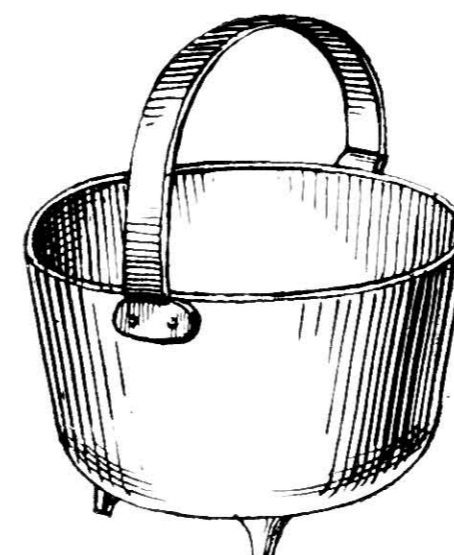

**Wigan Pan.**

Sizes, ...	4x3	5 1/2 x 3 1/2	6 1/2 x 3 1/2	6 1/2 x 4 1/2	7 x 4 1/2	8 x 5	8 x 5	9 x 5 1/2	10 1/2 x 6 1/2 ins.
Thickness,	1/8	1/4	1/4	1/8	1/4	1/8	1/4	1/8	1/8
Pots only,	2/3	2/3	2/6	3/3	3/6	3/9	4/3	4/6	5/- each.
Pots with bail handles,	3/3	3/3	3/9	4/6	5/-	5/3	6/-	6/3	6/9
Sizes, ...	...	...	...	...	...	...	...	11 1/2 x 6 1/2	13 1/2 x 9 ins.
Pots only,	...	...	...	...	...	...	...	7/6	10/6 each.
Pots with bail handles,	...	...	...	...	...	...	...	9/6	12/6

If supplied with ring base instead of feet, 4 to 8 ins., 6d.; 9 to 13 1/2 ins., 9d. each extra.



**Earth Rammer.**

Round,	10	12 lbs.
Prices,	2/9	3/6 each.
Square,	...	12 lbs.
Price,	...	3/6 each.

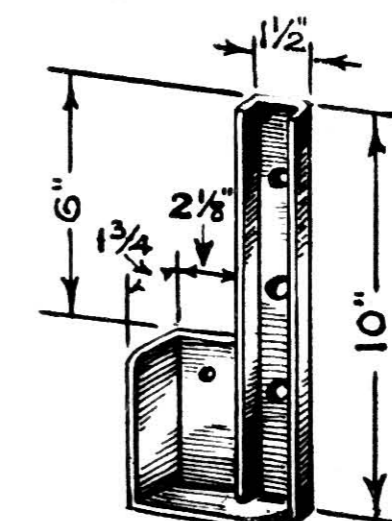

**Bed Socket.**

10 x 3 1/2 ins. .... 2/- per pair.

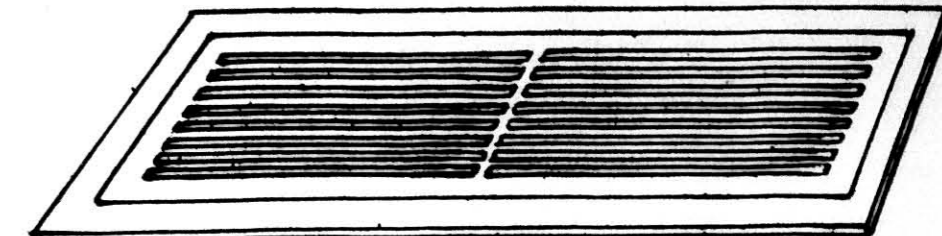

**ASH GRATE AND FRAME.**

Grating 3/8 in. thick.				
Sizes over Grating, ...	12x15	12x16	14x18	14x20 ins.
Frame, ...	15x18	15x19	17 1/2 x 21 1/2	17x23
Prices, ...	6/9	7/6	9/-	9/6 each.

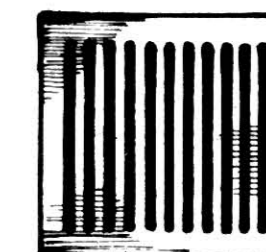

**Straight Bar Pattern.**

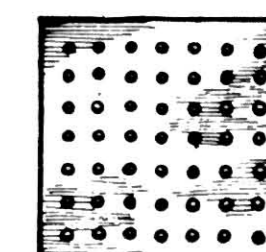

**Perforated Round Hole.**

<b>BLOWER GRATES—Straight Bar Pattern.</b>										
Sizes, ...	6x6	7x8	8x8	9x9	10x10 ins.					
Thickness,	1/2	1/2	1/2	1/2	1/2					
Prices, ...	12/9	21/-	22/6	27/9	33/9 doz.					
<b>BLOWER GRATES—Perforated Round Hole.</b>										
Sizes, ...	6x6	7x7	7x8	8x8	8x8	8x9	9x9	9x9	10x10	11x11 ins.
Thickness,	3/8	3/8	3/8	3/8	3/8	3/8	3/8	3/8	3/8	1/2
Prices,	15/9	21/9	24/-	27/9	30/-	33/9	31/6	34/6	45/-	57/- doz.

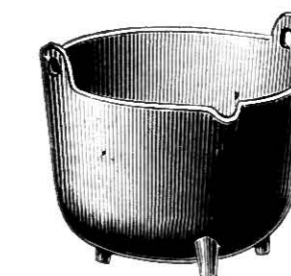

**Plumbers' Pot.**

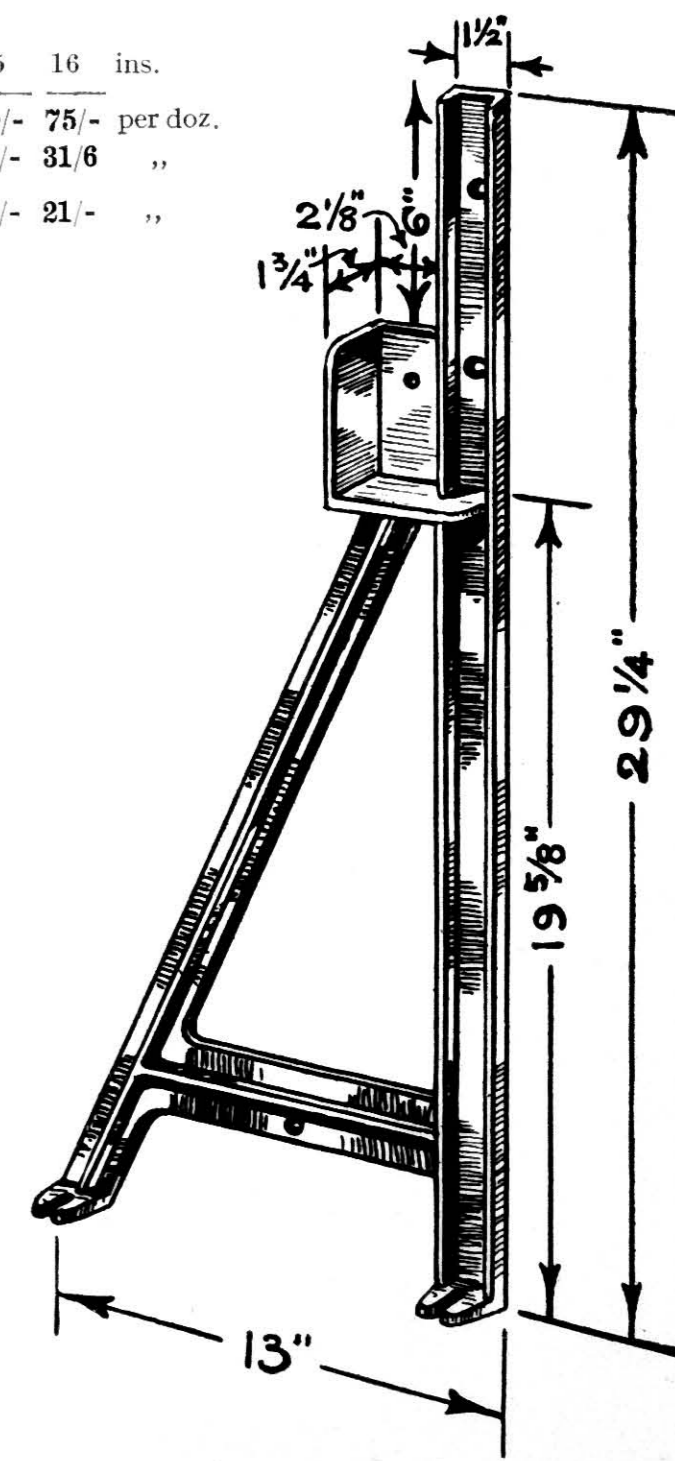

**Bed Standard.**

29 1/4 x 13 ins. .... 7/6 per pair.

Any of the above Castings can be supplied Coated at an extra of 7 1/2%.



# Sink Traps, Tobies and Mica Flap Ventilators.

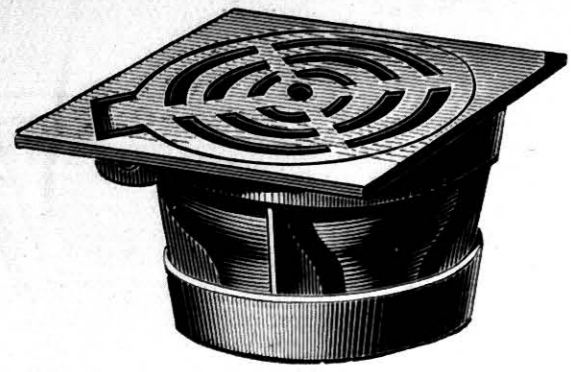

Liverpool Trap.

Sizes, 6 7 8 9 ins.

Prices, 3/9 4/3 4/9 5/9 each.

Sizes, 10 11 12 ins.

Prices, 6/9 8/- 9/3 each.

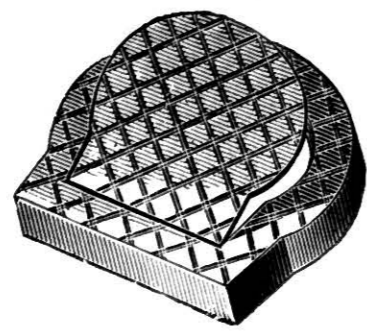

No. 8 Stop Cock Cover.

Sizes, 6 6½ 9 ins.

Depth, 7/8 1 1¼ "

Prices 3/- 3/3 5/3 ea.



Round Bell Trap.

Sizes, 2½ 3 3½ 4 6 ins.

Prices 1/6 1/7½ 1/9 1/10½ 2/9 ea.

Sizes, 8 10 11 12 ins.

Prices, 4/6 6/- 7/6 8/9 ea.

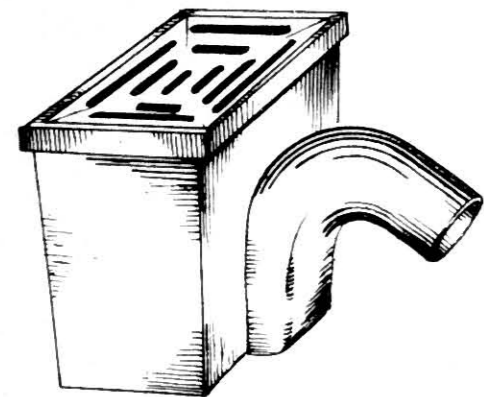

Clark's Patent Trap—Square.

10 × 7 × 9 ins. deep, 27/9 each.

14 × 10 × 10 ins. deep, 37/6 "

CLARK'S PATENT TRAP, with Lift-out Dirt Box, coated with Dr. Smith's Solution.

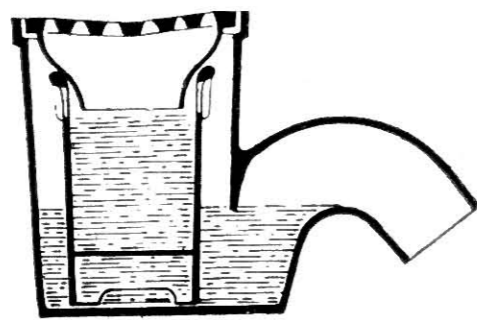

Clark's Patent Trap—Section.

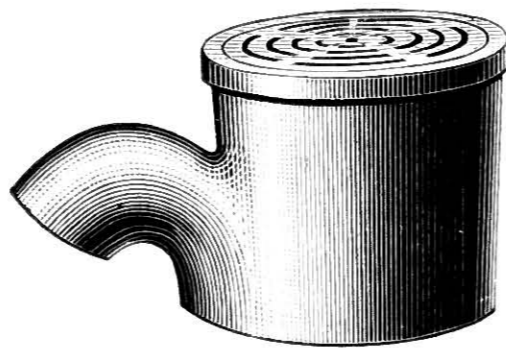

Clark's Patent Trap—Round.

8 ins. dia. × 8½ ins. deep, 16/6 ea.

10 ins. dia. × 9 ins. deep, 18/9 "

## TOBIES.

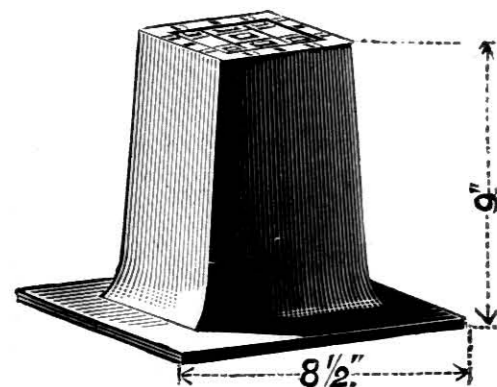

No. 1 7/- each.

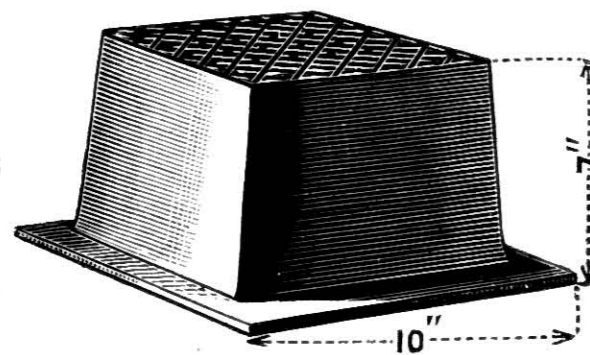

No. 3 8/6 each.

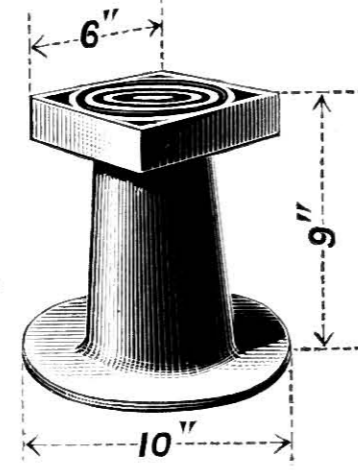

No. 4 9/6 each.

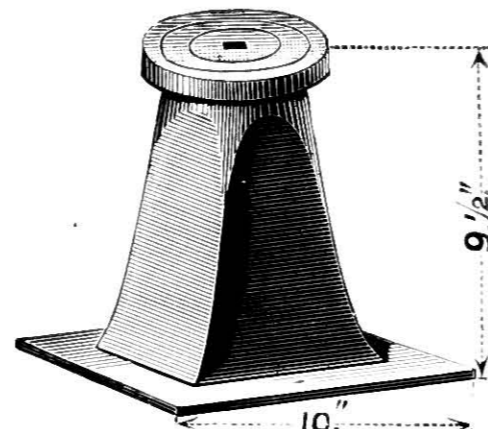

No. 2 7/6 each.



No. 5 Tobie.

Top, 5½ ins. sq.

Bottom, 6½ " "

Height, 6½ ins.

5/9 each.

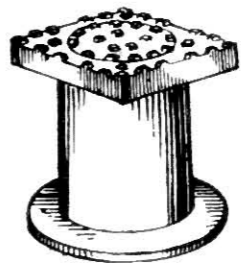

No. 7 Tobie (Square Top)

Top, 5½ × 5½ ins.

Dia. at Bottom, 7 ins.

Height, 6 "

6/- each.



No. 6 Tobie.

Cover, 5½ ins. dia.

Body, 6½ " "

Extreme, 9 " over bats.

3/- each.

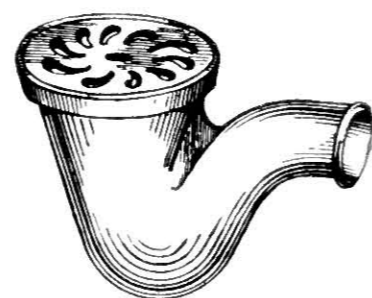

No. 6 Gully Trap.

Dia. of Grating, 6 ins.

Height, 7 "

Outlet, 3 "

4/- each.

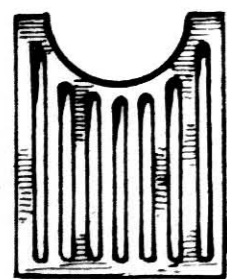

Hart Trap Grating.

½ in. thick.

To suit 3 inch Pipe.

6½ × 5½ ins., 11/3 doz.

To suit 2½ and 3 inch Pipe.

7½ × 5½ ins., 12/9 doz.

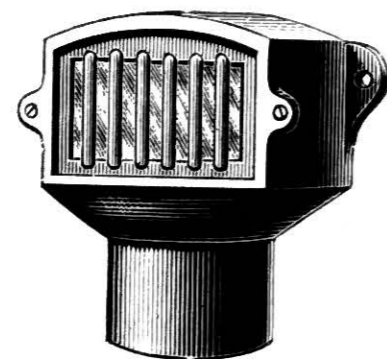

Mica Flap Ventilator with Brass and Mica Front.

Sizes, 3 4

Fine Cast, 48/- 51/- doz.

Galvanized, 57/- 60/- "

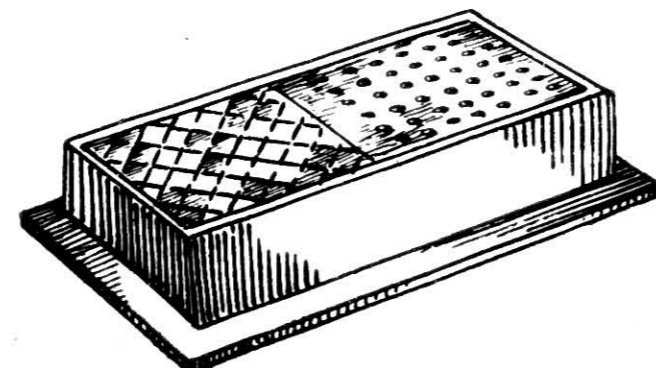

Buchan Trap or Surface Box.

Sizes,

Top 7 × 13, Bottom 10½ × 16½, Height, 4 ins.

10/6 each.

Tobies or Traps, Coated, 7½% extra.

# MANHOLE FRAMES AND COVERS.

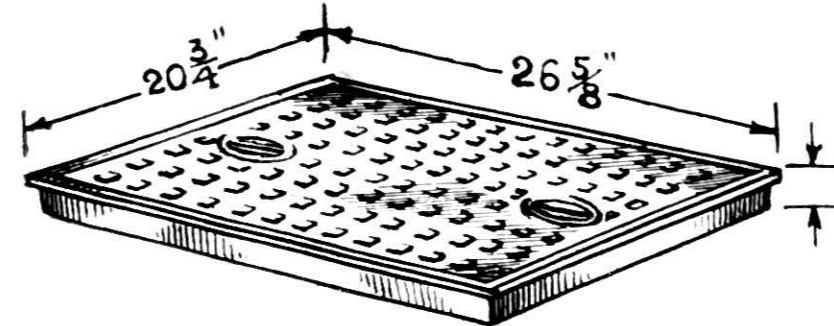

Section of Light Pattern.

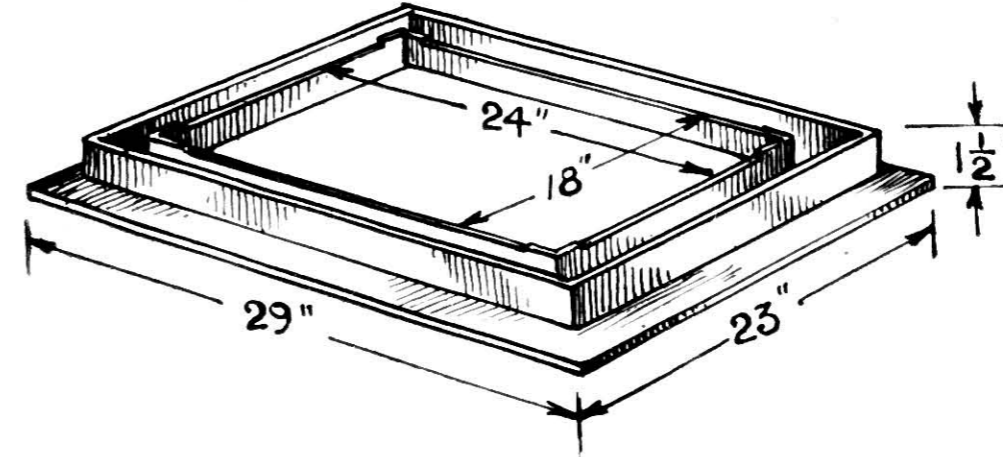

Section of Heavy Pattern.

## Manhole Frames and Covers.

Sizes inside.	Approximate Weights.	Prices.
9 × 9 ins.,	16 lbs.,	5/- each.
12 × 12 "	24 "	6/9 "
12 × 12 "	40 "	9/9 "
12 × 12 "	54 "	12/6 "
12 × 15 "	64 "	15 - "
12 × 18 "	39 "	10 - "
14 × 21 "	84 "	21 - "
15 × 15 "	35 "	9/9 "
15 × 15 "	72 "	16 - "
16 × 24 "	70 "	17/- "
18 × 18 "	42 "	11/3 "
18 × 18 "	55 "	14 - "
18 × 18 "	86 "	21 - "

Sizes inside.	Approximate Weights.	Prices.
18 × 18 "	112 lbs.,	26/3 each.
18 × 24 "	43 "	12/- "
18 × 24 "	55 "	14/3 "
18 × 24 "	64 "	15/9 "
18 × 24 "	89 "	21/9 "
18 × 24 "	105 "	25/6 "
18 × 24 "	142 "	33 - "
18 × 30 "	161 "	37/6 "
24 × 24 "	95 "	22/6 "
24 × 24 "	130 "	33/9 "
24 × 24 "	171 "	39 - "
24 × 30 "	259 "	60/- "
24 × 36 "	275 "	66 - "

Manhole Step (Iron), 5¼ × 6 × 15¼ in. overall.

Fine Cast, 2/- each.

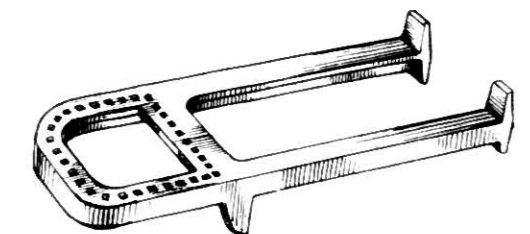

## STOP TAP AND SURFACE BOXES.

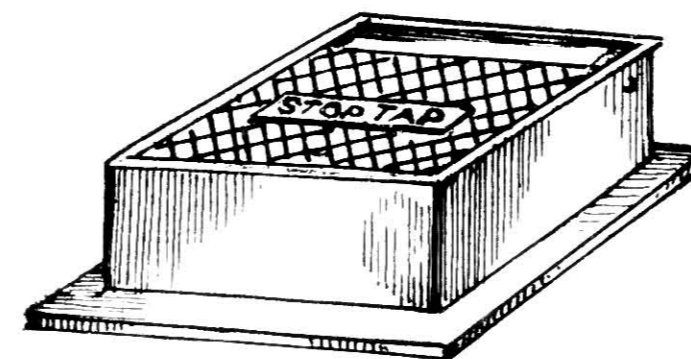

No. 9 Stop Tap Box.

Hinged Cover.

Sizes.

Top, 6 × 5 7½ × 6 ins.

Bottom Flange, 7¼ × 6¾ 10 × 8¼ "

Depth, 3 3¼ "

Prices, 4/6 6/- each.

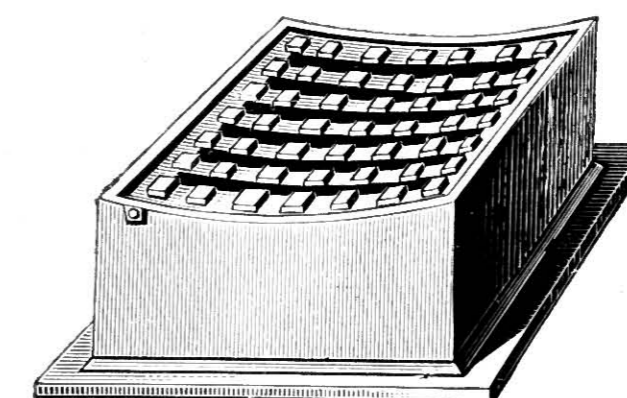

Sewer Grate and Frame, Grating to lift out.

18½ × 13½ ins. at top.

23 × 18¼ ins. over bottom flange.

7½ ins. deep.

39/- each.

If Coated, 7½% extra.

25

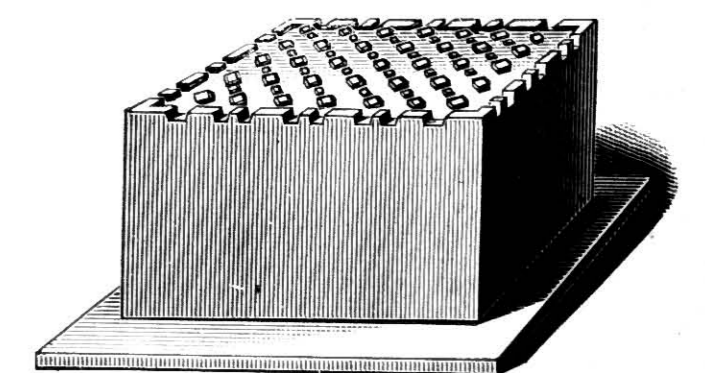

Surface Box with Cover to lift out

14 × 10 ins. at top.

18¼ × 14¾ ins. over bottom flange.

9 ins. deep.

27/9 each.



# FURNACE PANS.



Gallons.	Dia. at Mouth.	Dia. over Flange.	Depth inside.	Approx. Weight.			
				Cwts	Qrs.	Lbs.	
4	14 ins.	16 3/8 ins.	9 1/4 ins.	0	0	19	Imperial Gallons.
6	15 1/2 "	17 5/8 "	12 1/4 "	0	0	18	
8	17 "	19 1/2 "	13 1/2 "	0	0	24	
10	18 5/8 "	20 7/8 "	14 1/2 "	0	1	2	
12	19 1/8 "	21 3/8 "	15 1/2 "	0	1	8	
14	20 1/2 "	22 7/8 "	16 1/4 "	0	1	14	
16	21 1/8 "	23 3/4 "	17 1/4 "	0	1	20	
18	21 3/4 "	24 1/2 "	17 1/2 "	0	1	26	
20	23 3/8 "	26 1/8 "	17 3/4 "	0	2	4	
25	24 5/8 "	27 3/8 "	18 3/4 "	0	2	19	
30	26 1/2 "	29 1/4 "	21 "	0	3	14	
35	27 3/8 "	30 3/8 "	21 "	0	3	20	
40	28 1/2 "	31 1/2 "	22 "	1	0	12	
45	29 "	32 1/8 "	23 7/8 "	1	1	9	
50	29 7/8 "	32 7/8 "	23 3/4 "	1	2	6	
60	30 3/8 "	33 3/8 "	25 3/4 "	1	2	18	
70	31 3/8 "	34 5/8 "	25 "	1	3	12	
80	33 1/4 "	36 1/4 "	26 1/2 "	2	1	12	
85	34 3/8 "	37 1/2 "	27 1/4 "	2	2	3	
90	36 1/4 "	39 7/8 "	28 1/2 "	2	2	10	
100	37 3/8 "	40 3/8 "	29 "	2	2	20	

### PRICES.

<b>Black,</b>	6-25	30-100 gallons.
	1/-	1 1/2 per gallon.
		4 Gallon Pans charged as 6 gallon.

### EXTRAS.

Boss cast on,	2/11	4/3 each extra.
Boss cast on, tapped and screwed,	6/11	10/5 "
Spout cast on,	6/9	8/4 "
Spout cast on, tapped and screwed,	10/9	14/5 "

### Barffed,

6-25	30-100 gallons.
1/5 1/2	1 9/10 per gallon.
	4 Gallon Pans charged as 6 gallon.

### EXTRAS.

Boss cast on,	4/7	5/11 each extra.
Boss cast on, tapped and screwed,	8/7	12/1 "
Spout cast on,	8/4	9/11 "
Spout cast on, tapped and screwed,	12/5	16/- "

Prices of Galvanized Pans on application.

# COAL SAVERS, FURNACE DOORS, AND GRATES, &c.

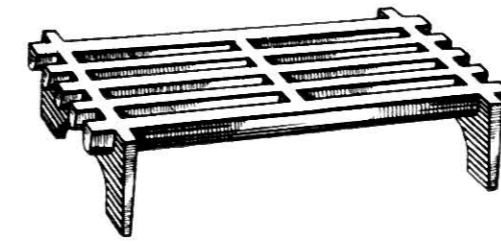

**FALSE BOTTOMS.**  
 4 Bar—4 1/2 ins. wide x 2 3/4 ins. deep. 5 Bar—5 1/2 ins. wide x 2 3/4 ins. deep.

Sizes,	8	9	10	11	12	13	14	15	16	17	18	ins.
4 Bar,	15	16	18	19	21	22	24	25	6	—	—	doz.
5 Bar,	17	18	19	21	22	24	25	27	30	32	—	doz.

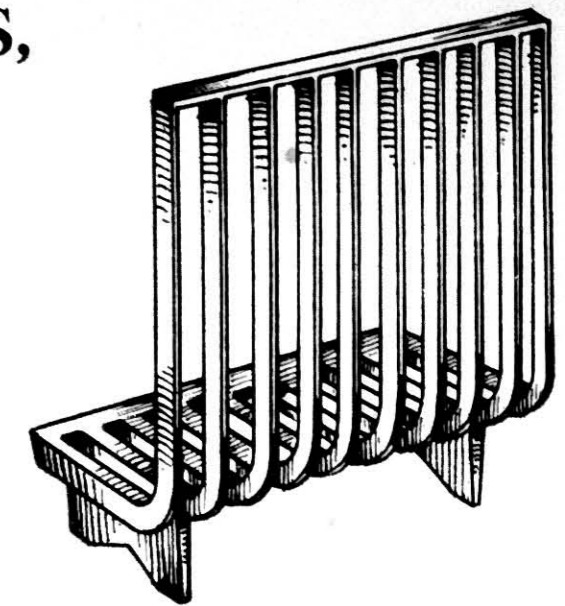

**COAL SAVERS.**

Sizes,	7	8	9	10	11	12	Bar
Prices,	10/6	12/-	13/6	15/-	16/6	18/-	doz.
Sizes,	13	14	15	16	17	18	Bar
Prices,	19/6	21/-	22/6	24/-	25/6	27/-	doz.

### FURNACE DOORS AND GRATES.

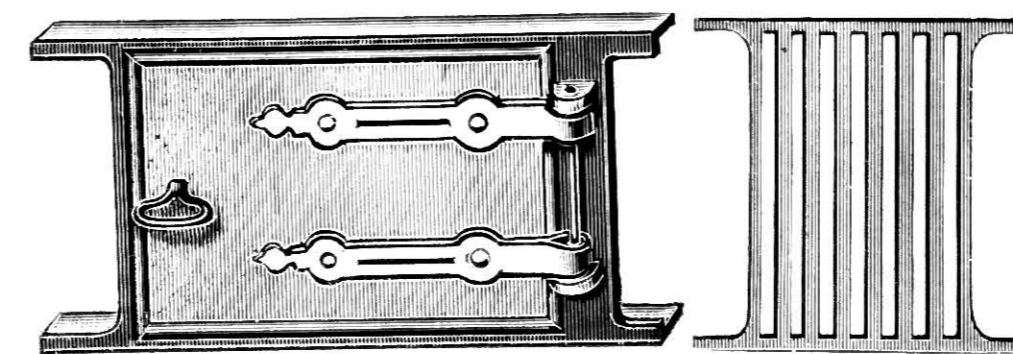

No. 1 FURNACE DOOR AND BOTTOM GRATE.

#### Light Pattern.

Sizes,	6	7	8	9	10	ins.
Furnace Door & Frame,	2/6	2/9	3/-	3/3	3/9	each.
Furnace Grate,	1/6	1/9	2/-	2/6	3/-	..

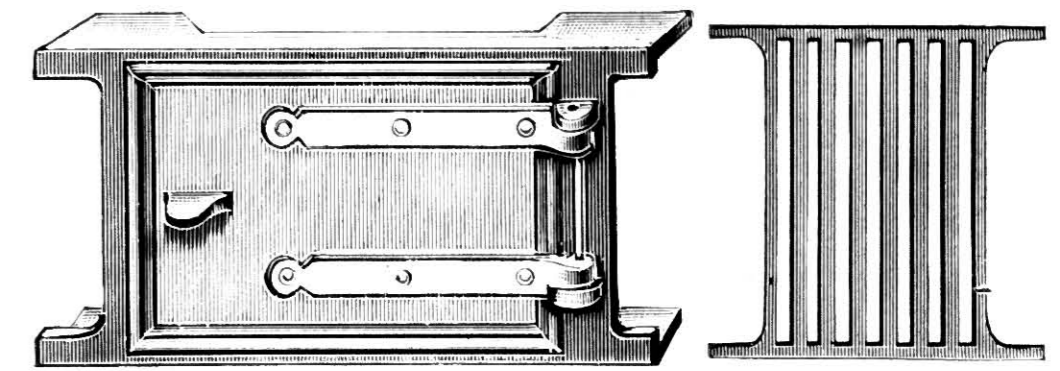

No. 2 FURNACE DOOR AND BOTTOM GRATE.

#### Heavy Pattern.

Sizes,	6	7	8	9	10	11	12	14	ins.
Furnace Door and Frame,	3/-	3/3	3/6	4/-	4/6	5/-	6/-	7/-	each.
Furnace Grate,	1/9	2/-	2/9	3/3	4/-	4/9	6/-	7/-	..

### FURNACE BARS AND BEARERS.—22/6 per cwt.

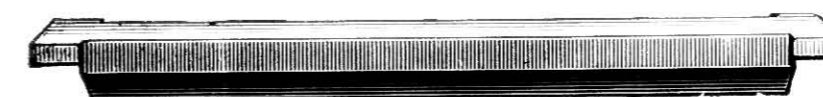

Medium Bars

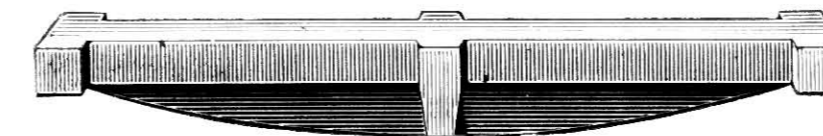

Fish Bellied Bars.

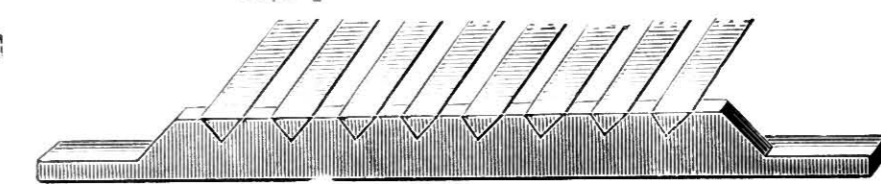

V Bars and Bearer.

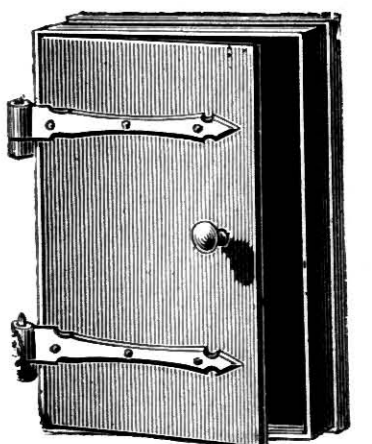

No. 3 HINGED CLEANING DOOR, 8x11 ins.

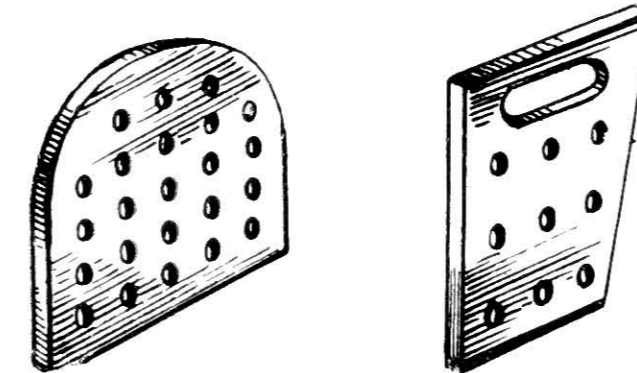

Boiler Hole Plates. Niggets or Perforated Fire Cheeks.

**BOILER HOLE PLATES.** 1/2 in. thick.

Sizes,	6x6	6x7	7x7	7 1/2 x 7 1/2	ins.
Prices,	12/3	13/6	15/9	16/6	doz.
Sizes,	7x8	8x8	8x9	9x9	ins.
Prices,	17/3	18/-	21/-	24/-	doz.

### NIGGETS OR PERFORATED FIRE CHEEKS.

All 1/2 in. thick.

Sizes	7x6 x 3 1/2	8x6 x 4	9x6 1/2 x 4	9 1/2 x 6 1/2 x 3 3/4	ins.
Prices,	13/6	15/9	18/-	18/-	doz.
Sizes,	9 1/2 x 6 1/2 x 4 1/2	10x6 1/2 x 4	10x7x4	ins.	
Prices,	18/-	18/9	18/9	doz.	
Sizes,	10x7x4 1/2	10x7x5	10x7 1/2 x 5	10 1/2 x 7 1/2 x 4	ins.
Prices,	20/3	21/-	21/9	20/3	doz.

### SLIDING DAMPER AND FRAME, with Long Handle, No. 3.

Sizes,	6x8	7x9	8x10	14x9	ins.
Prices,	3/-	4/-	4/9	8/6	each.

### SLIDING DAMPER AND FRAME, with Knob.

Sizes,	4 1/2 x 4 1/2	5x6	7x9	8x10	9x9 1/2	ins.
Prices,	1/9	2/3	3/6	4/-	4/3	each.
Sizes,	9x12	10x12	11x12	12x14	14x9	ins.
Prices,	4/6	5/3	6/-	7/6	7/6	each.

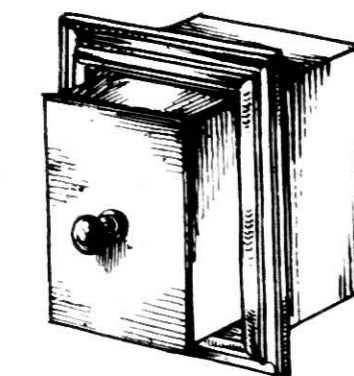

No. 1 SOOT BOX AND FRAME.

Sizes,	4x4	6x4	6x6	9x6	9x9	ins.
Prices,	3/3	3/9	4/3	5/3	6/-	each.

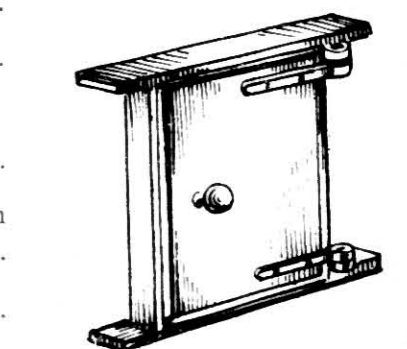

No. 4 HINGED CLEANING DOOR, 7x8 1/2 ins. Nos., 3 4 Prices, 12/9 4/6 each.

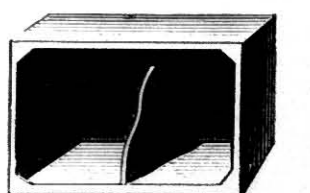

No. 2 "ABERDEEN" SOOT BOX. 4x6 ins 1/3 each.



## GARDEN SEATS.

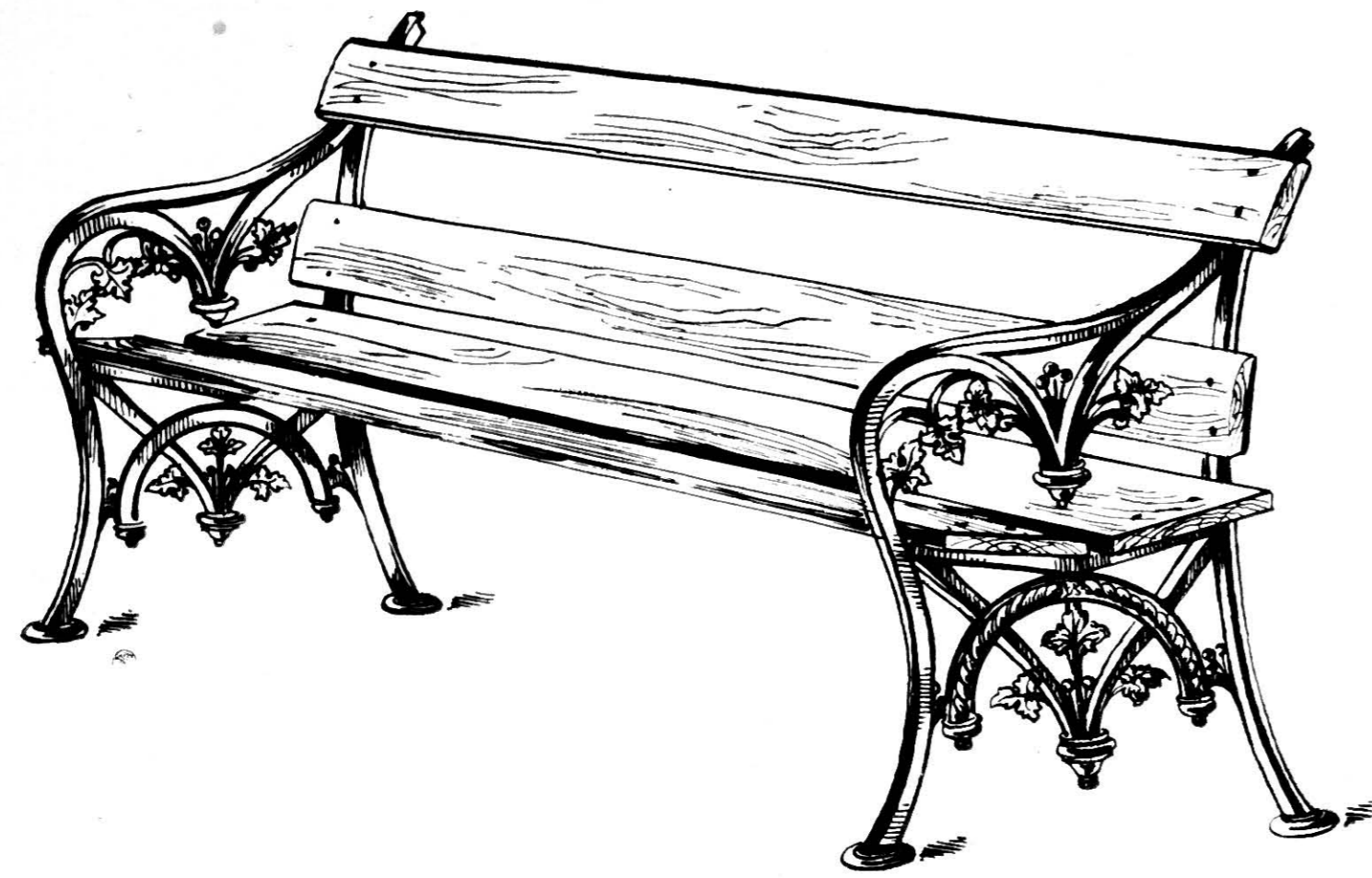

No. 3 Garden Seat, ends painted green, wood work pitch pine, stained and varnished.

Sizes,	.....	5 ft.	6 ft. long.
Prices,	.....	63/-	67/6 each.
Arms only—Fine Cast, 18/- pair.			

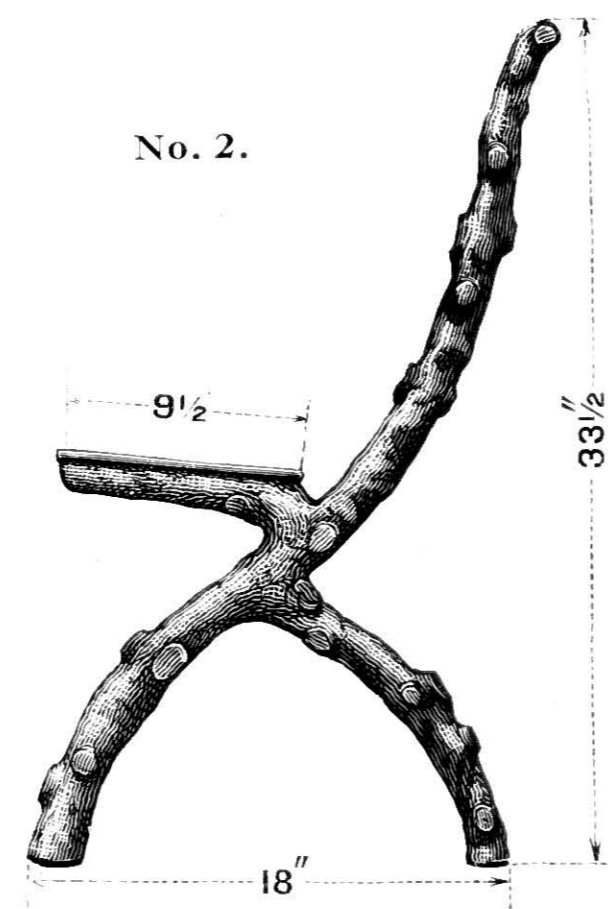
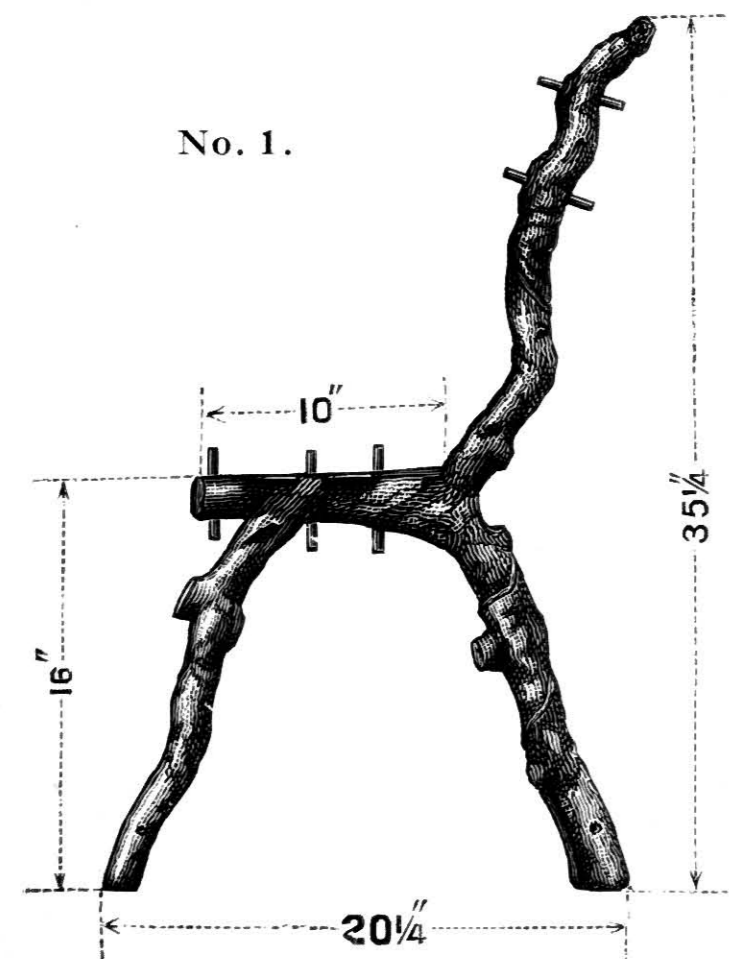

### GARDEN SEAT STANDARDS.

Nos.	.....	1	2
Prices,	.....	24/-	22/6 per pair.

## GARDEN SEAT STANDARDS.

No. 9.

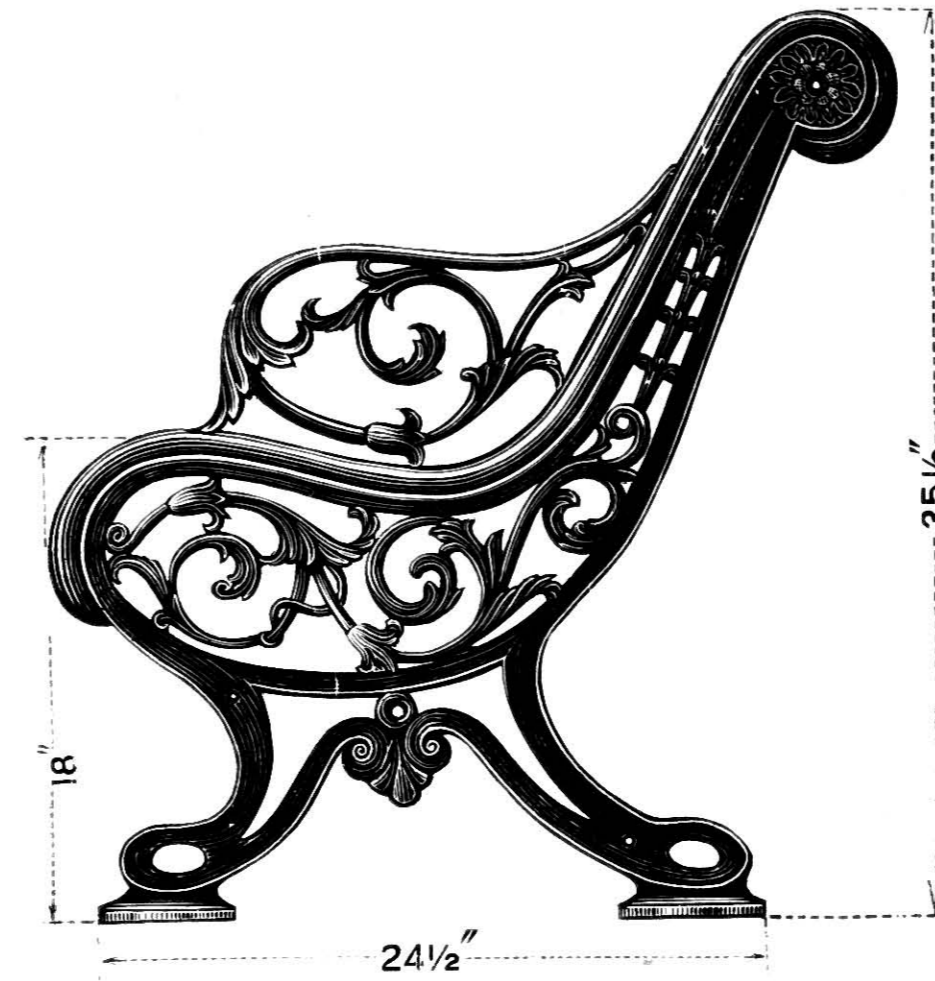

No. 8.

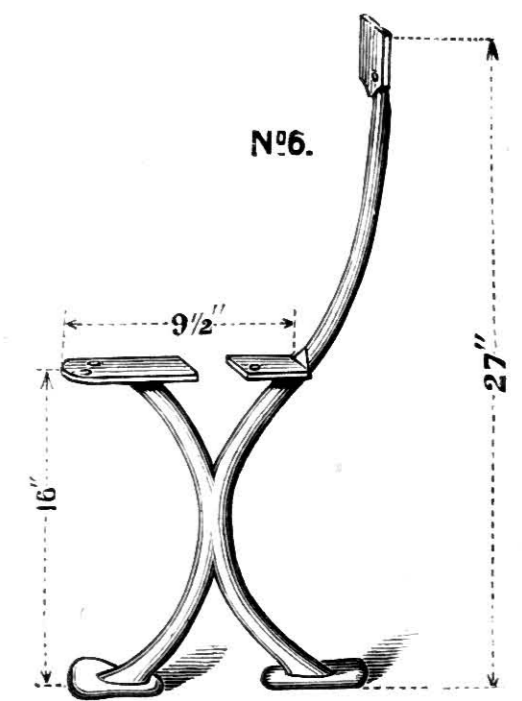
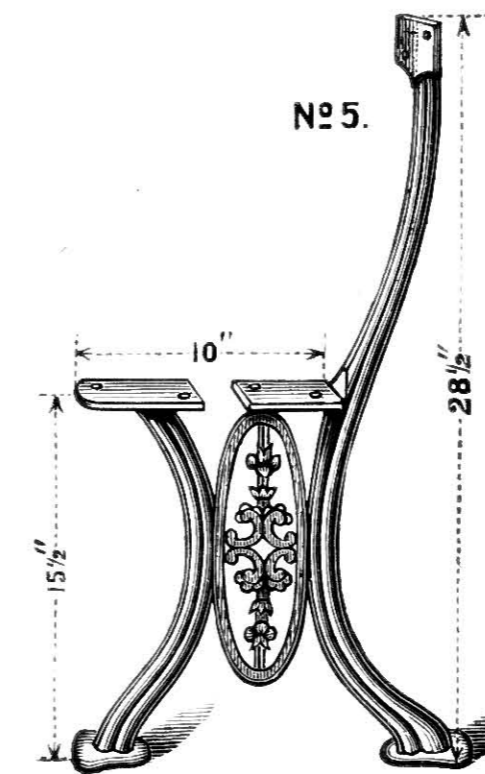
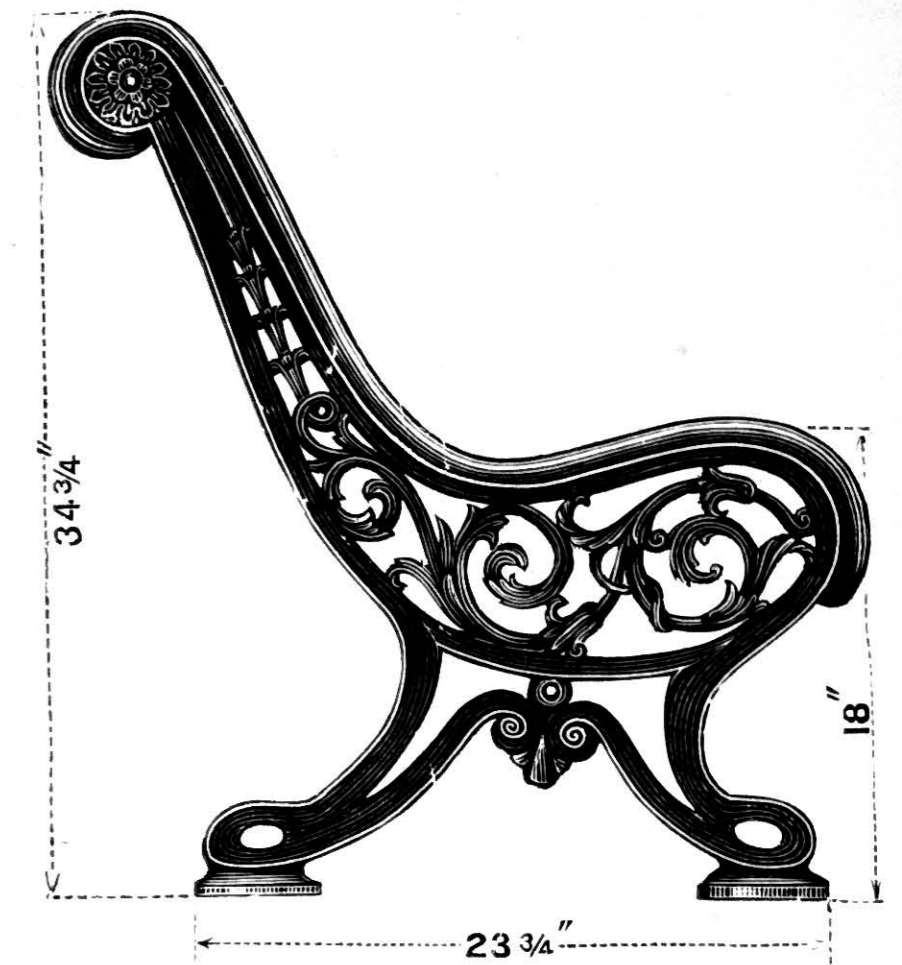

### GARDEN SEAT STANDARDS (only Fine Cast).

Nos.,	.....	9	8	5	6
Prices,	.....	39/-	39/-	10/6	10/- per pair.



## REFRESHMENT ROOM TABLES.

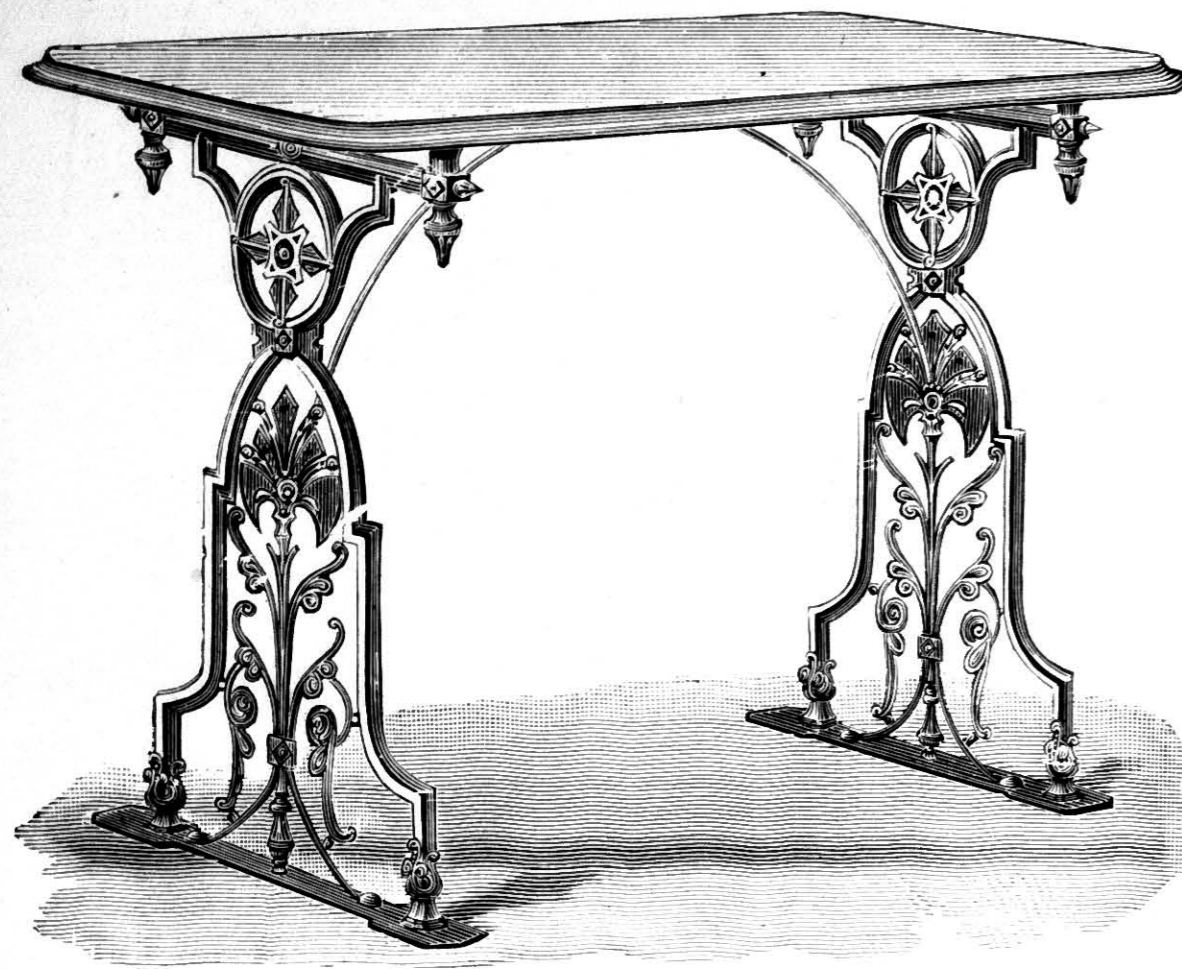

**No. 1 TABLE STAND.**

Prepared for Wood Top.

Height, ....	28 ins. × 36	42 ins. long.
Fine Cast, ....	27/-	27/9 each.
Stove Blacked or Painted and Bronzed,	36/-	36/9 ..
Fitted with Wood Top,	30/-	33/9 extra.



**No. 25 ROUND TABLE.**

Top, 24 ins. dia. Height, 30 ins.

Fine Cast, ....	45/- each.
Ground on top, Stove Blacked or Bronzed,	60/- ..

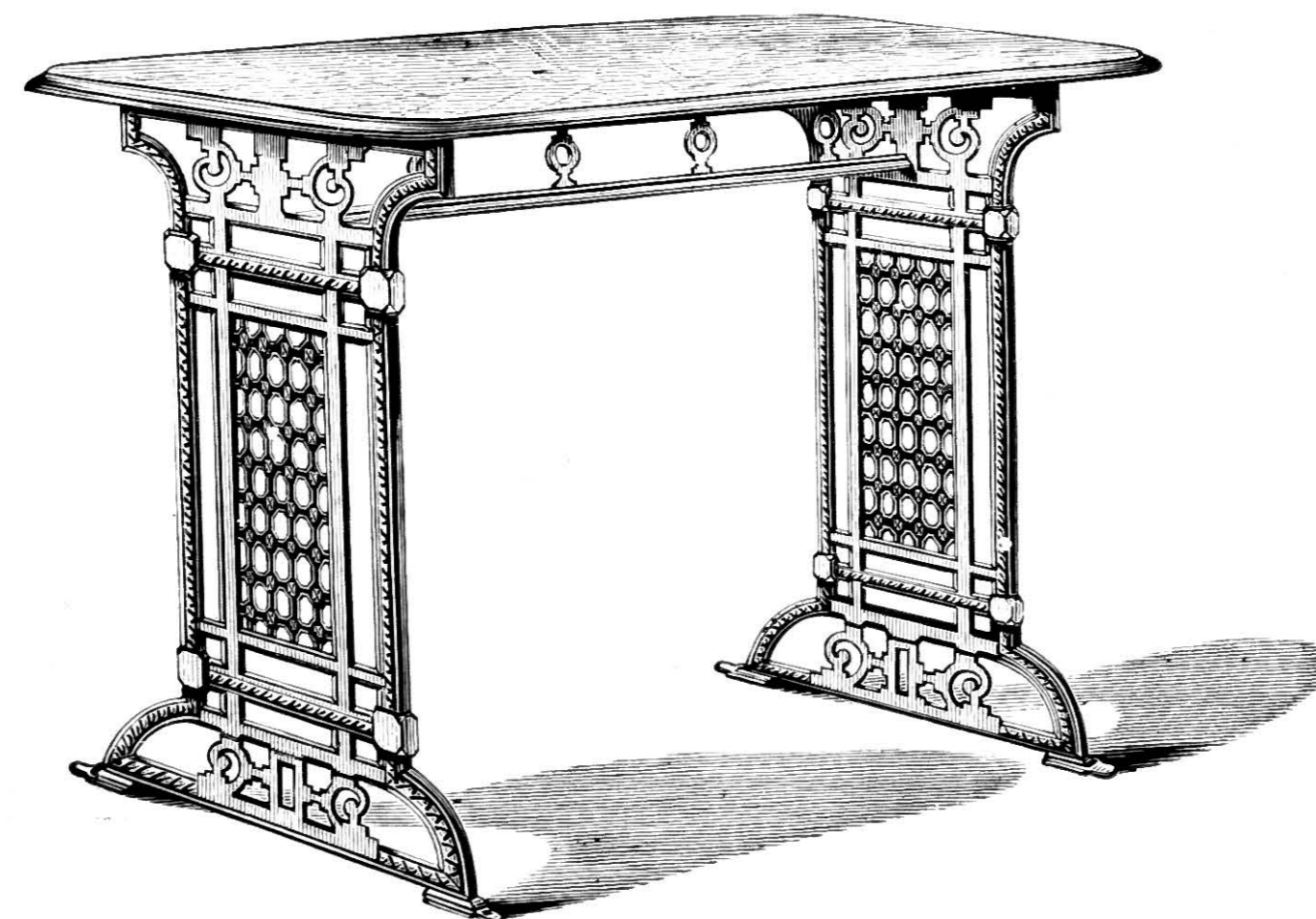

**No. 5 TABLE STAND.**

Prepared for Wood Top, 28 × 36 ins. long.

Fine Cast, ....	26/3 each.
Stove Blacked or Painted and Bronzed,	35/3 ..
Fitted with Wood Top, ....	30/- extra.

	Nos.,	1	5	
Standards only, Fine Cast,	....	15/-	15/-	per pair.
		30		

## REFRESHMENT ROOM TABLES AND SUN DIALS.

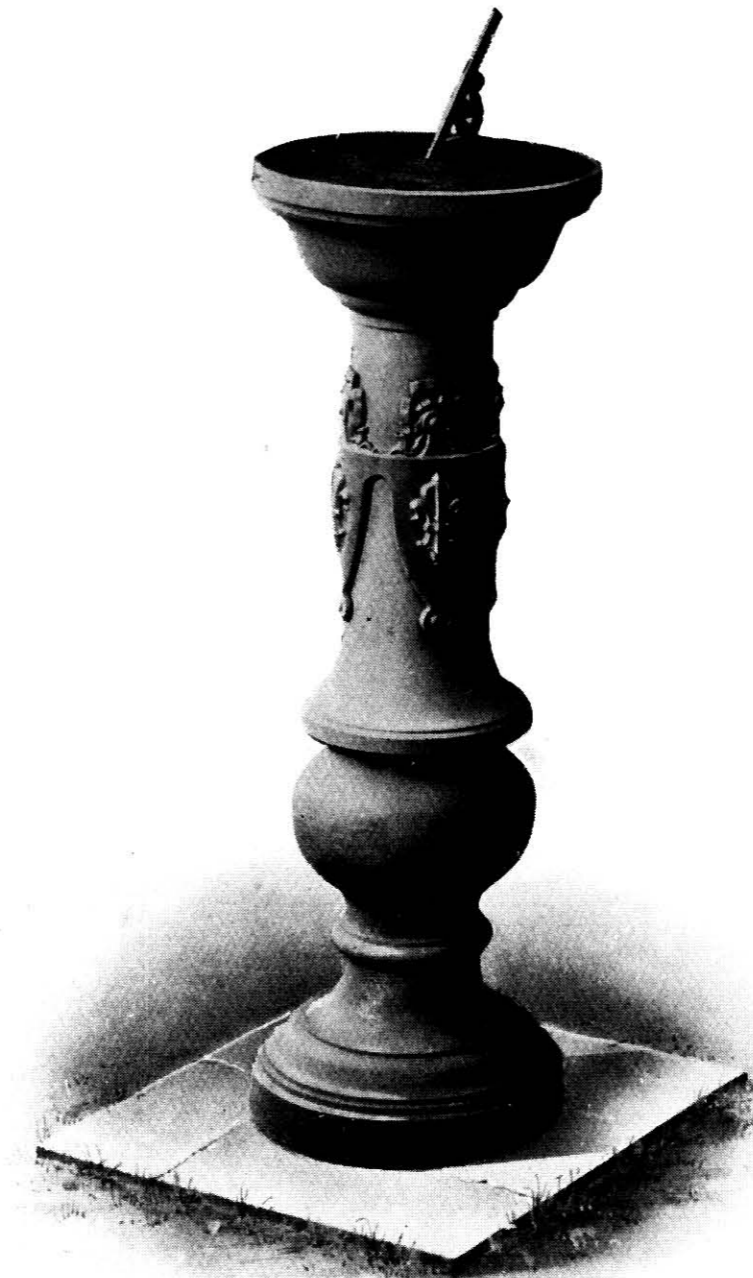

**No. 1 SUN DIAL.**

Pillar, 32½ ins. high. Brass Dial and Gnomon,  
11¼ ins. dia.

Body Primed 2 Coats White Paint, 105/- each.



**No. 10 TABLE STAND.**

Prepared for Wood Top.

Height, 28 ins.	Length, 36 ins.
Fine Cast, ....	24/9 each.
Stove Blacked or Painted and Bronzed,	33/9 ..
With Wood Top, ....	36/- extra.

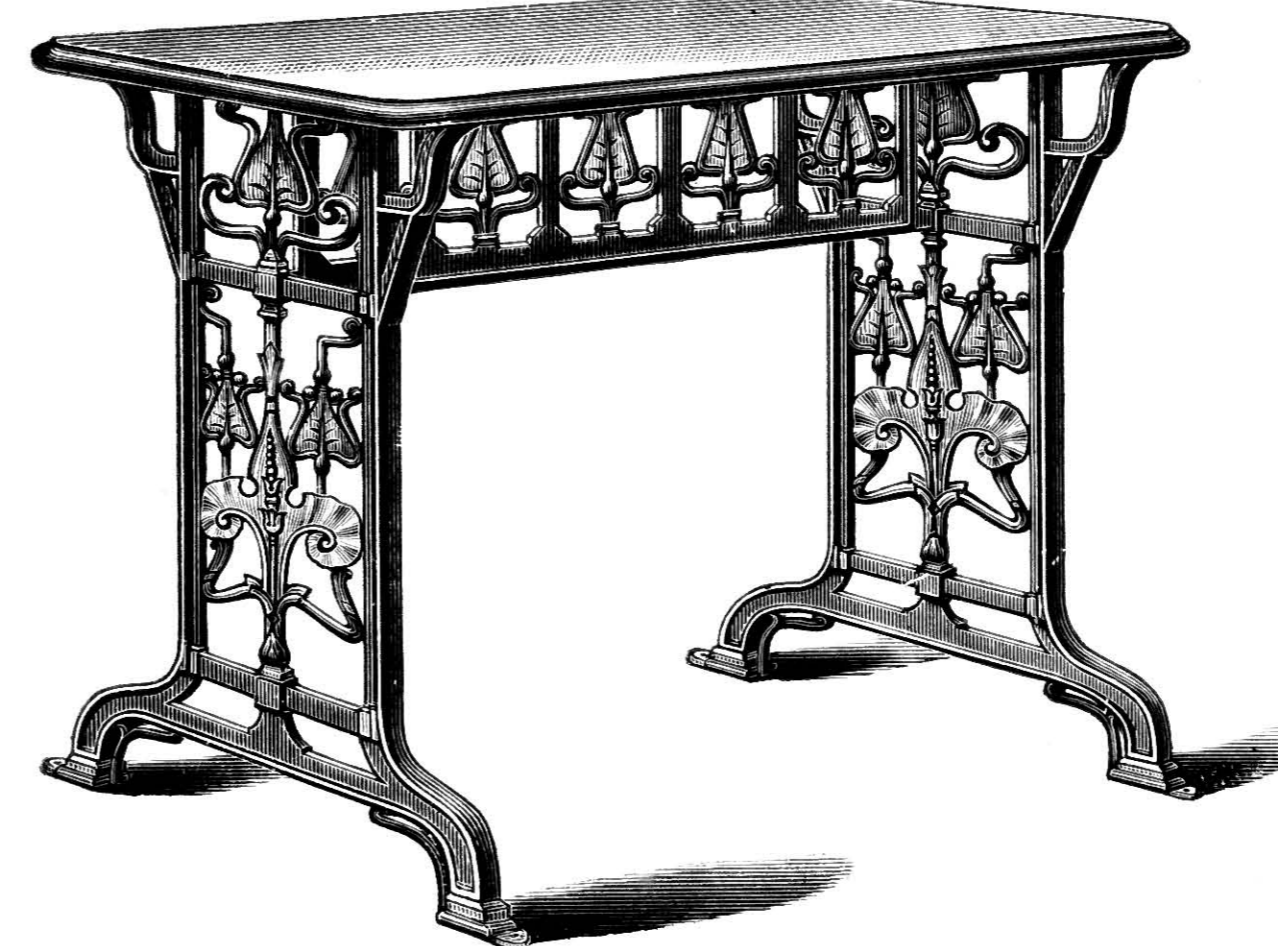

**No. 15 TABLE STAND.**

Prepared for Wood Top. Height, 28½ ins.

Sizes, ....	36	42 ins. long.
Fine Cast, ....	27/9	30/- each.
Stove Blacked or Painted and Bronzed,	36/9	39/- ..
With Wood Top,	36/-	39/- extra.

	Nos. 10	15
Table Standards only,	14/3	15/- per pair.



**No. 2 SUN DIAL.**

Pillar, 32½ ins. high. Brass Dial and Gnomon,  
10¾ ins. square.

Body Primed two Coats White Paint,  
112/6 each.



# WRINGER PLATES, CLOTHES POSTS & SOCKETS.

No. 1 Heavy Pattern.

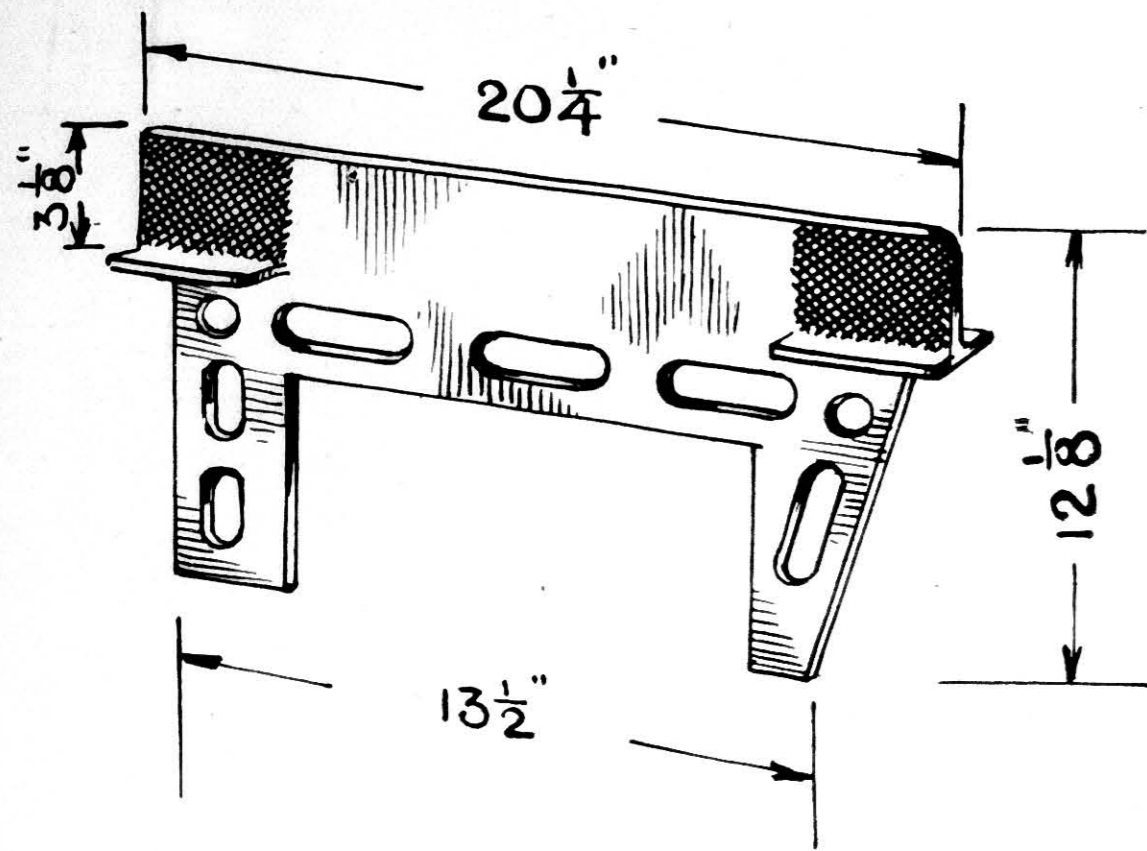

No. 2 Light Pattern.

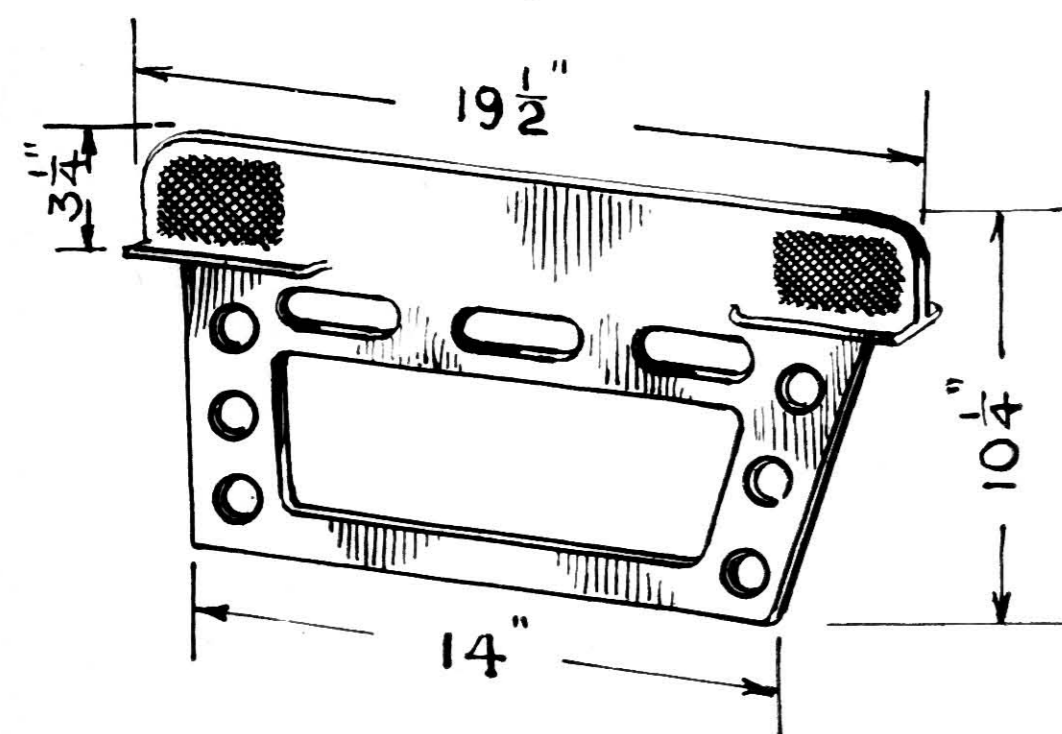

Wringer Plates.

Nos.	1	2
Galvanised,	8/3	7/- each.

Clothes Posts.

No. 0, .... Wrought Iron.  
Nos. 1 and 2, .... Cast Iron.

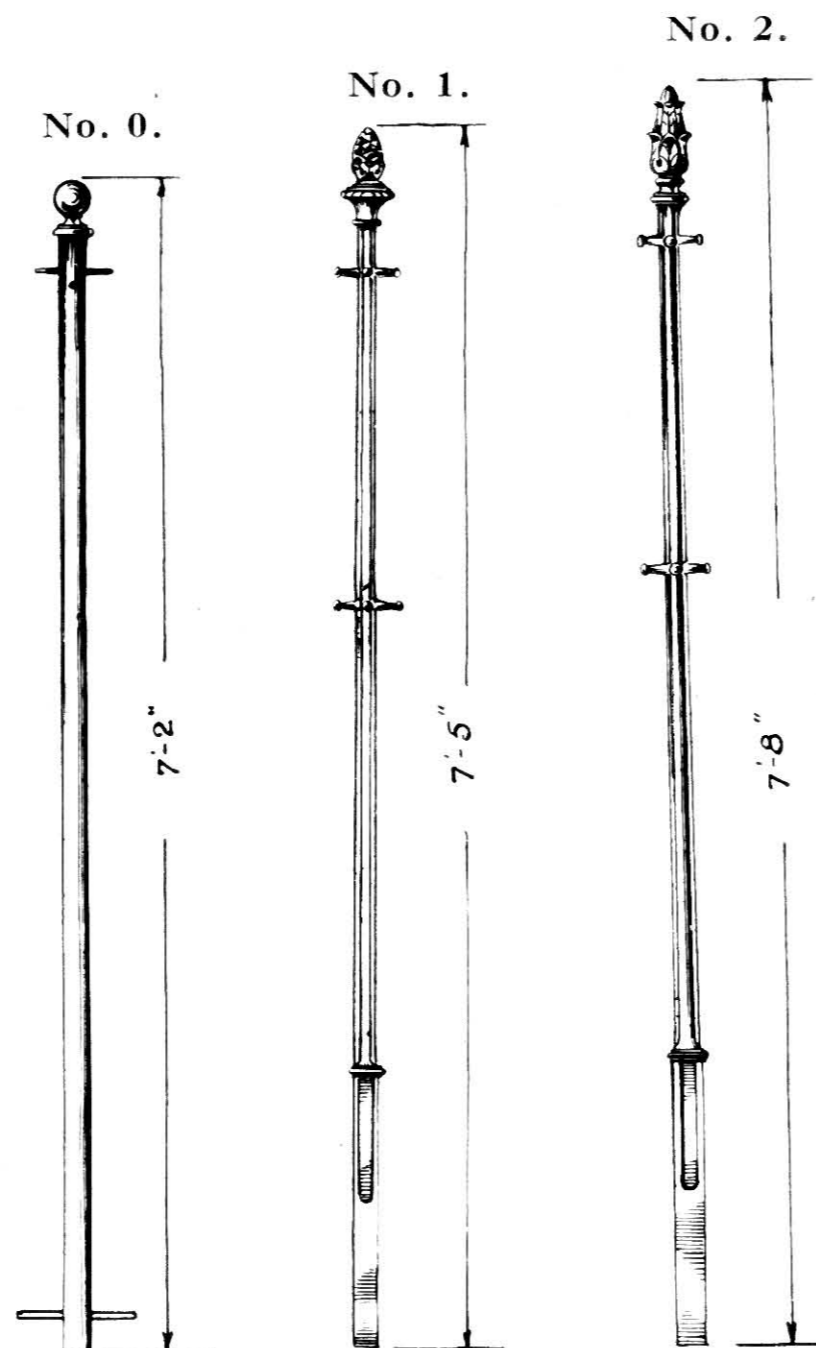

Clothes Posts.

Nos.,	0	1	2
Prices,	17/3	19/6	19/6 each.

Clothes Post Sockets.

Nos.,	1	2	3	4
Prices,	7/6	12/-	10/6	10/6 each.

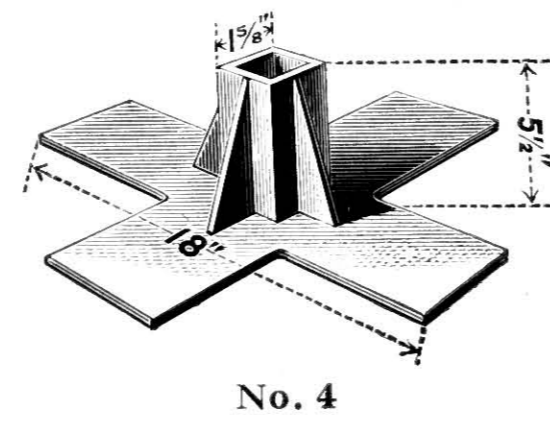
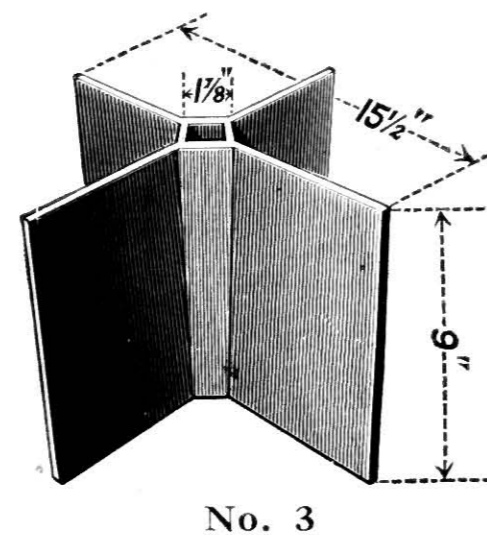
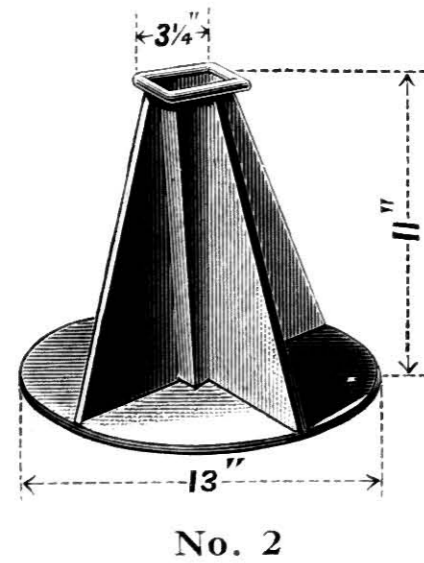

# FOOT SCRAPERS.

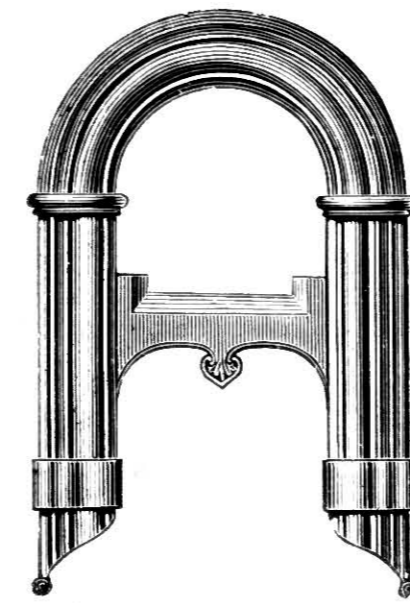

No. 1, 3/- each.

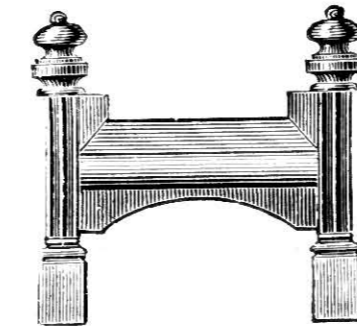

No. 3, - 2/3 each.

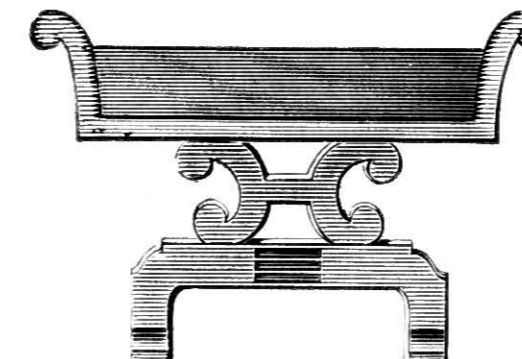

No. 12, - 4/6 each.

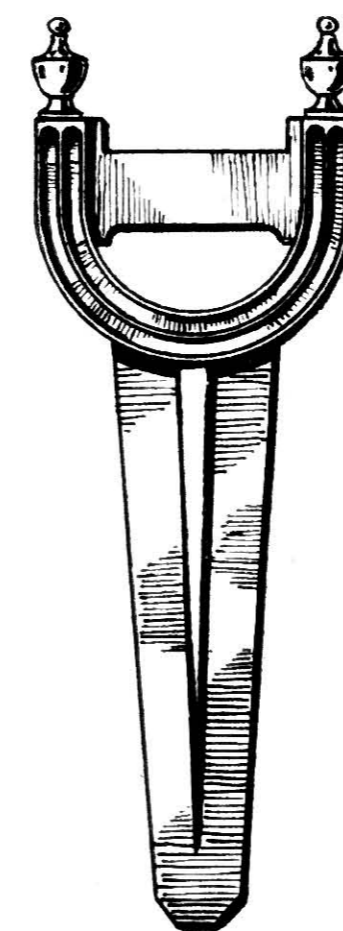

No. 26, - 3/9 each.

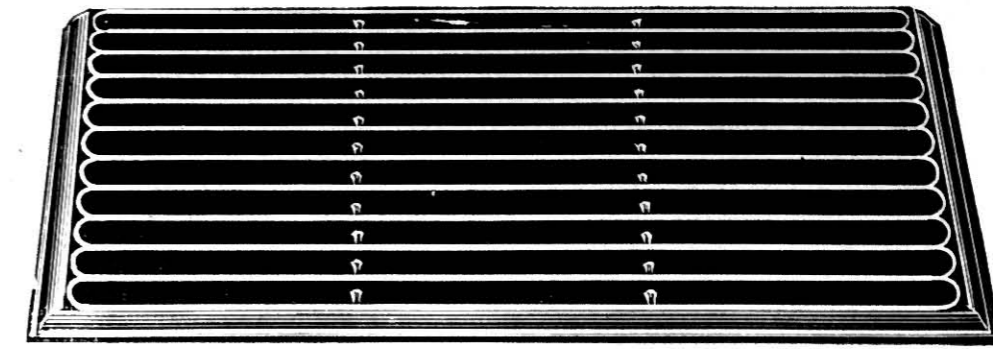

No. 24, - 6/- each.

CHANNEL SCRAPERS.

Sizes,	15 x 24	18 x 36	24 x 42 ins.
Prices,	9/-	18/-	25/6 each.

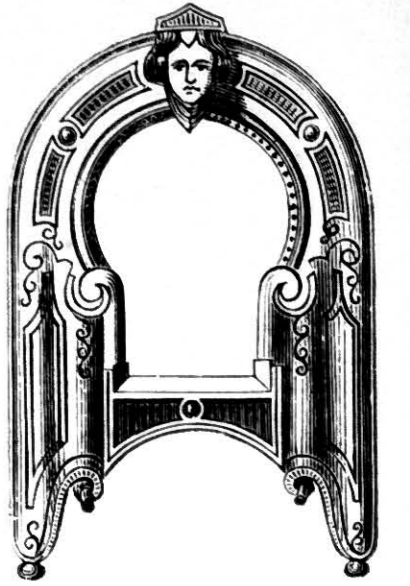

No. 2, - 3/- each.

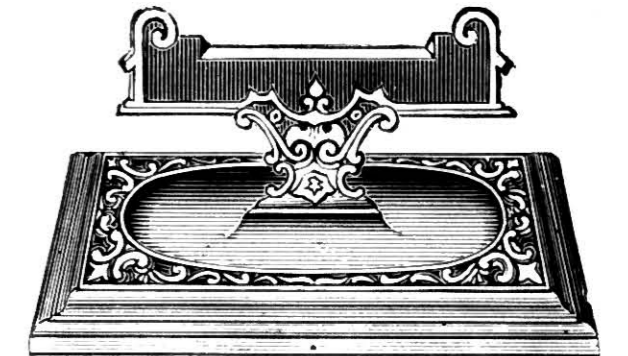

No. 6, - 5/3 each.

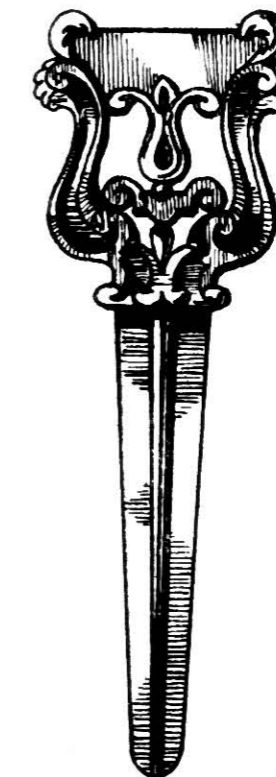

No. 27, - 3/- each.

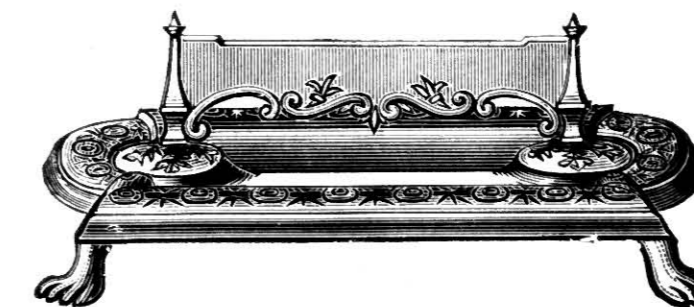

No. 39, - 7/- each.

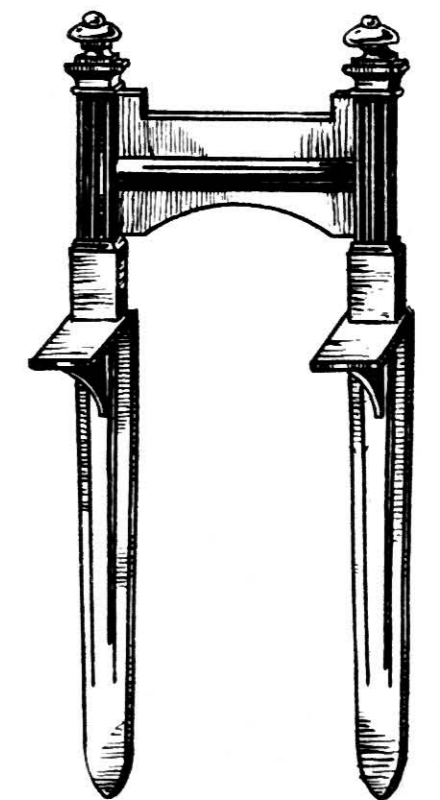

No. 25, - 3/9 each.

If Coated, 7 1/2% extra.



## SAD IRONS, &c.



**Sad Irons.**

Nos.	4	5	6	7	
Prices,	5/-	5/3	5/6	6/6	pair
Nos.,	8	9	10		
Prices,	6/9	8/3	9/3		pair



**Tailors' Irons.**

Nos.,	8	9	10	11
Weights,	10	12	14	16 lbs.
	6/-	6/6	6/9	7/6 ea.

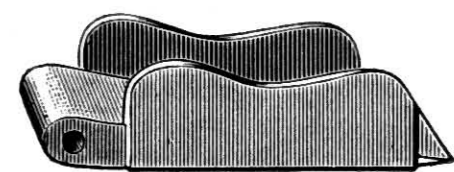

**Skid Irons.**  
24/6 per cwt.

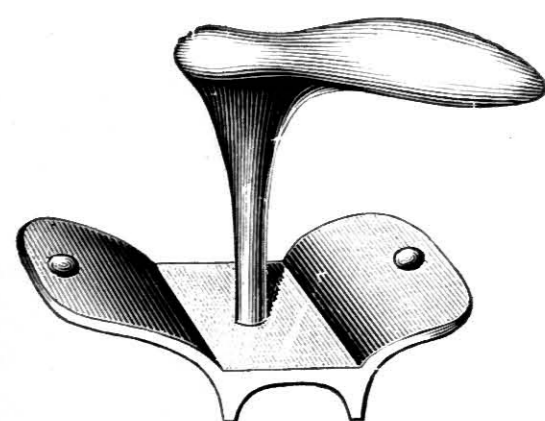

**Shoemakers' Lasts** comprising  
Knee Plates and 6 Lasts.  
5 to 10 ins., rising 1 in. 11/3 per set.



**"Siddons."**

Sizes, ...	5	5½	6 ins.
Prices,	4/6	5/6	6/9 doz.

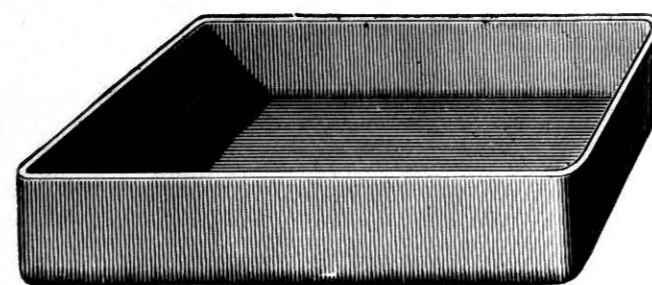

**Fish Pans.**

Sizes,	18×20	18×20	20×20 ins.
	4½	6	4½ "
Prices,	21/9	23/3	27/9 each.
Sizes,	20×24	24×24	24×30 ins.
	6	6	6 "
Prices,	26/3	31/6	39/- each.

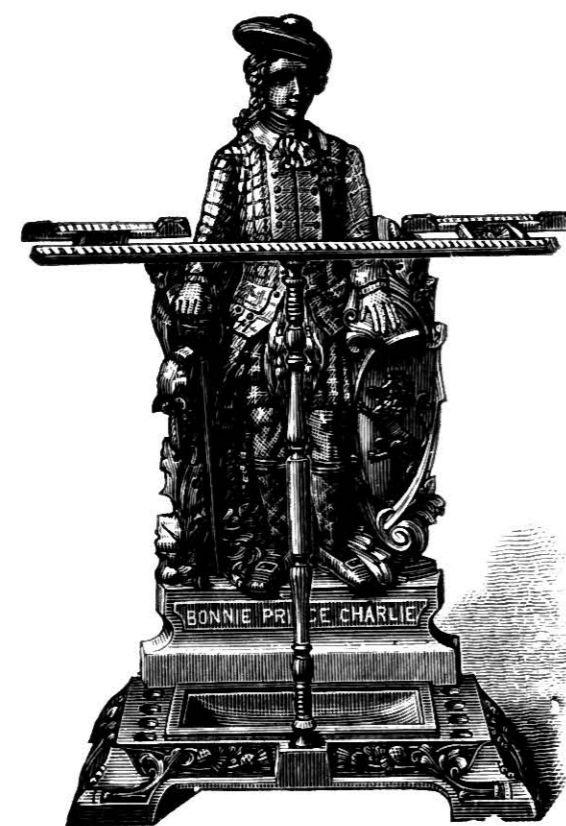

**No. 1 Umbrella Stand, Bronzed.**  
Sizes, 22 ins. wide×29 ins. high  
×10 ins. projection at base.  
30/- each.

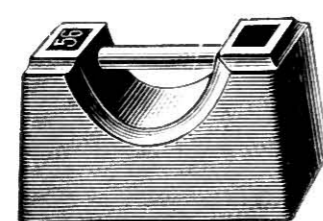

**Bar Weights.** Adjusted only,  
Weights, 1 2 4 7 lbs.

Prices,	1/3	1/6	2/-	2/9 each
Weights,	14	28	56 lbs.	
Prices,	4/-	7/-	12/9 ea.	

### BOX IRON HEATERS.

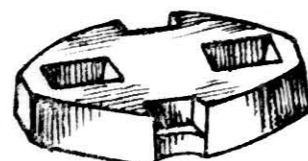

**"Mrs. Potts."**  
4/6 per doz.

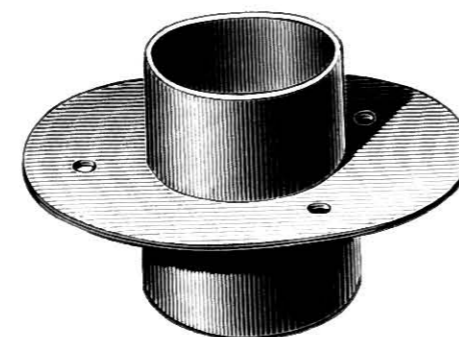

**Deck Flanges.**

Sizes,	3	3½	4	4½ "
Width of Flange, 2 ins.				
Prices,	2/6	2/9	3/6	3/9 each
Sizes,	5	6	7	8 ins.
Prices,	4/6	5/-	6/-	6/9 each.



**Sweep's Ball.**

Sizes,	4	4½	4½ in. dia.
Prices,	31/6	36/-	45/- per doz.



**Drinking Cup**  
with 2 ft. galvanised Chain.  
3/- each.

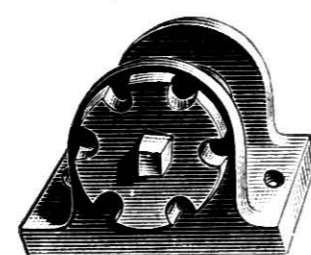

**Wire Strainers or Fence Ratchets**  
Coated, 27/- per doz.



**Stob Mallet.**

Weights,	10	12	14 lbs.
Price,	3/-	3/6	4/- each.

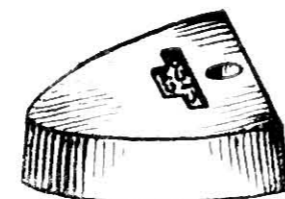

**Crane Heaters.**

Nos., ...	3	4	5	6	7
Prices,	5/6	6/-	6/3	7/9	9/- doz.

## MANGERS AND HAY RACKS.

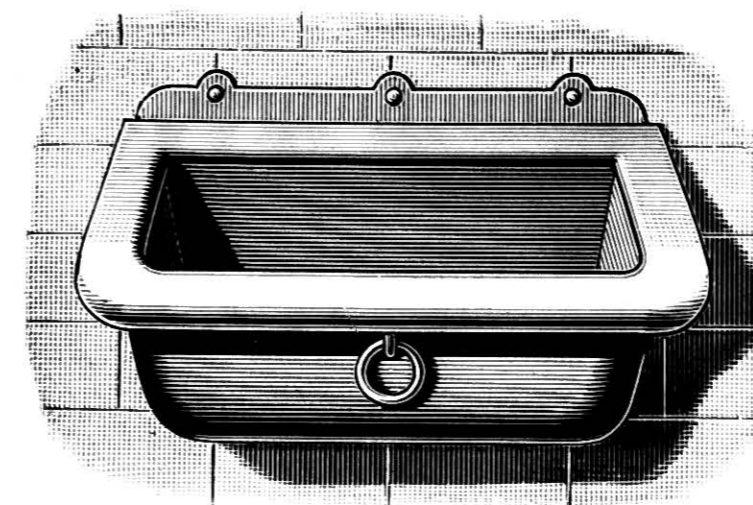

No. 1.

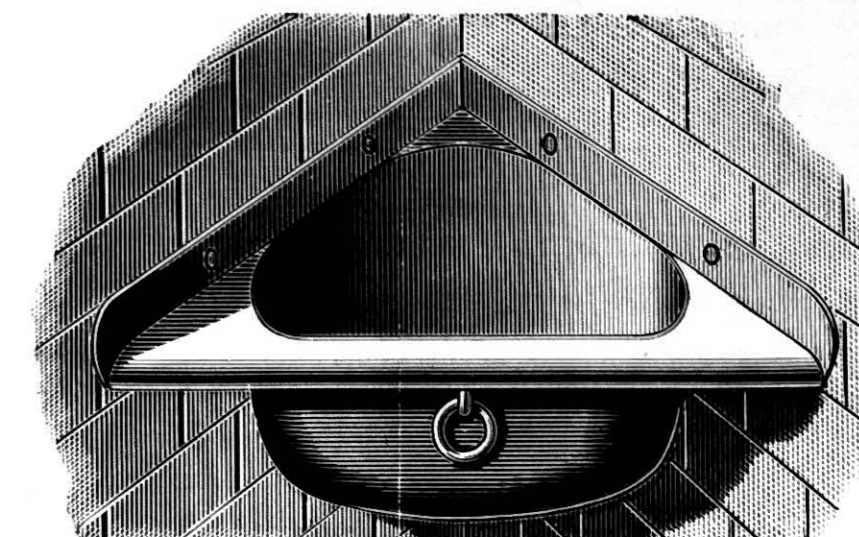

No. 2.

### CAST-IRON MANGERS with Wrought-iron Ring.

	No. 1.				No. 2.			
Sizes,	24	27	30	36	27	30	33	36 ins.
Prices,	13/6	15/-	16/-	21/-	13/6	14/6	16/-	18/- each.

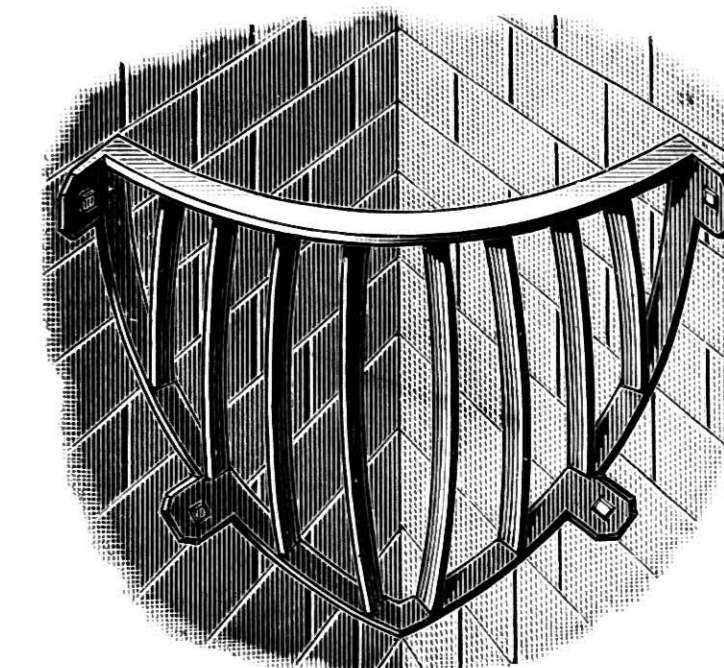
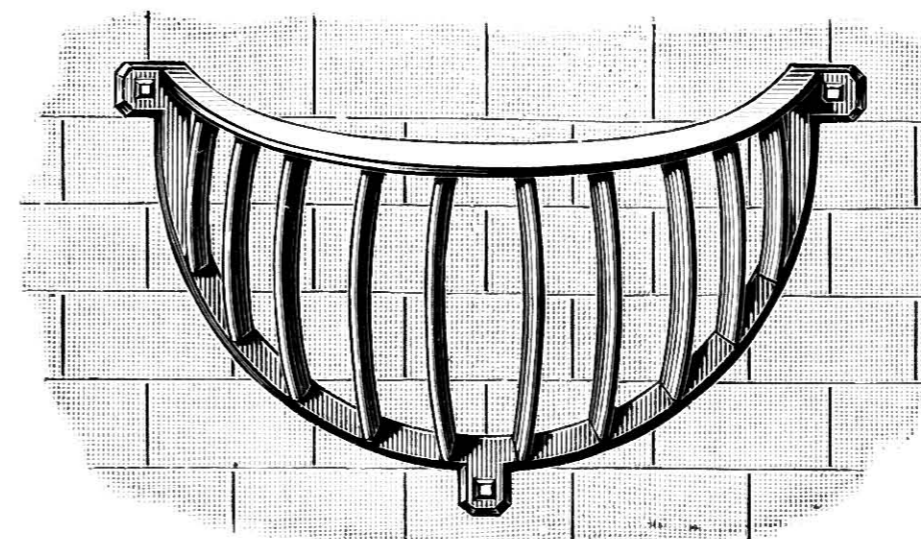

### CAST-IRON HAY RACKS.

Sizes,	30	33	36 ins.
For Flat Wall,	12/-	13/6	16/6 each.
For Corner Wall,	12/9	14/3	15/- "

## WHEELS.

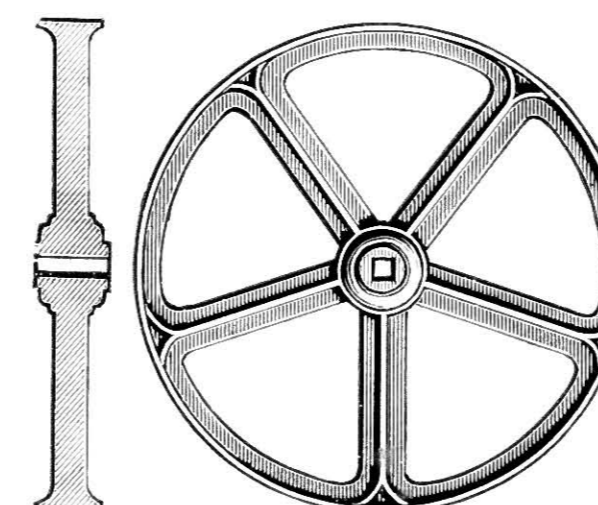

**BARROW WHEELS.**

Diameter,	6	7	8	9	10	12 ins.
Tread,	1½	1½	1½	1½	1½	1½ "
Price,	1/3	1/4½	1/6	2/-	2/3	3/3 ea.
Diameter,	14	16	17	18	18 ins.	
Tread,	2	2	2½	1½	2½ "	
Price,	5/3	5/6	6/6	6/-	7/- ea.	

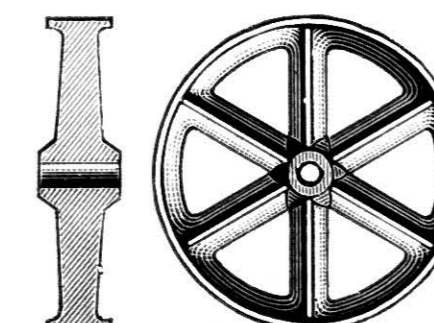

**No. 2 GRUBBER WHEELS.**

Diameter,	8	9	10 ins.
Tread,	2	2	2 "
Price,	2/9	3/-	3/3 ea.

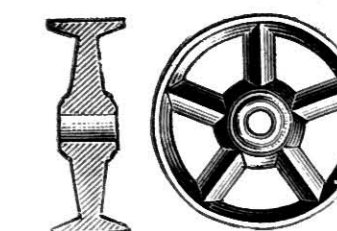

**TRUCK WHEELS.**

Diameter,	5	6	7	8	9 ins.
Tread,	1½	1½	1½	1½	1½ "
Price,	1/3	1/6	1/9	2/3	2/6 ea.
Diameter,	10	12	14	16 ins.	
Tread,	2	2½	2	2 "	
Price,	3/-	3/9	4/-	5/3 ea.	



# BLACK HOLLOW WARE.

LONG LEGGED POT.



Sizes of Pots.

Sizes,	1/2	3/4	1	1 1/2	2	2 1/2 galls.
	3	3 1/2	4	5	6	7 "
	8	9	10	12	14	16 "
	18	20	25	30	35	40 "

COMMON THREE-LEGGED POT.



COVERS FOR POTS & CAMP OVENS.

FLAT COVER.

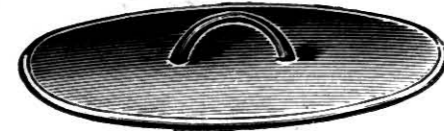

RAISED COVER.



CAMP OVEN WITH LONG LEGS.



Sizes, 8 9 10 11 12 13 14 ins.  
15 16 17 18 19 20 "

CAMP OVEN.

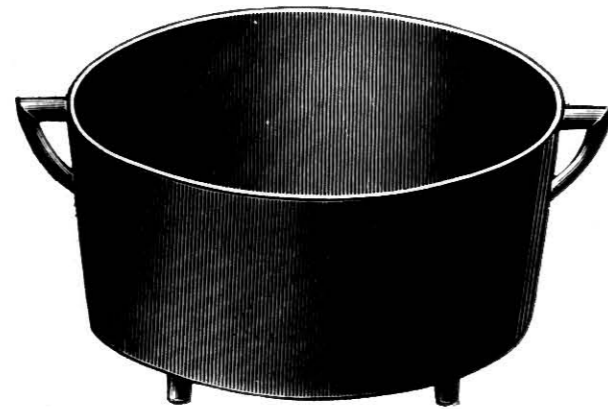

CASSADA PLATE.

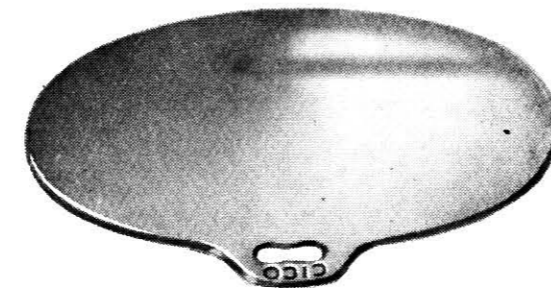

12 inches diameter.

DANISH PAN.

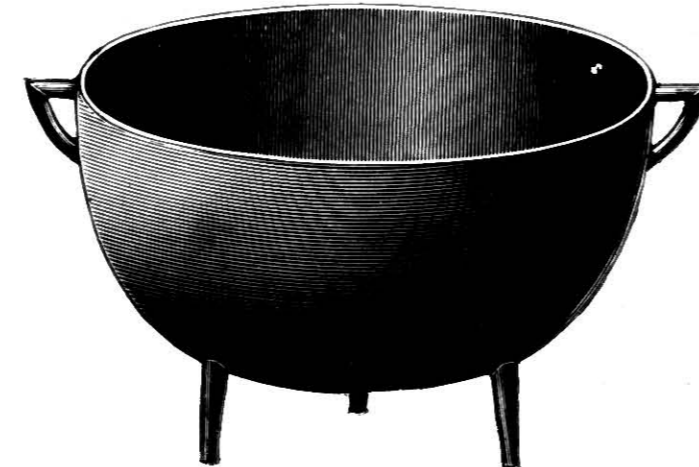

Sizes, 1 1 1 1 1/2 2 2 1/2 3 4 5 galls.

WROUGHT BOW OR BAIL HANDLE FOR POTS OR CAMP OVENS.



FRY PANS, with Cast-on Ears.  
8 to 18 ins., rising 1 inch.

FRY PANS, with long Cast Handles.  
8 to 18 inches, rising 1 inch.

FRY PANS, with Bow, Bow and Swivel,  
or Folding Bow and Swivel Handles.  
8 to 18 inches, rising 1 inch.

HARD OVAL POTS.

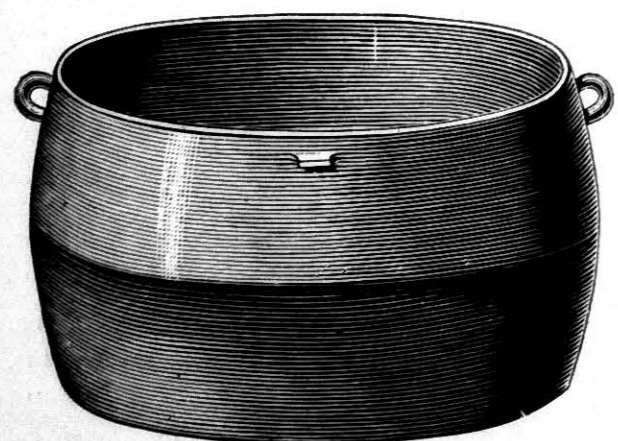

Sizes, 2 3 4 5 6 7 8 galls.

EARED FRY PAN.

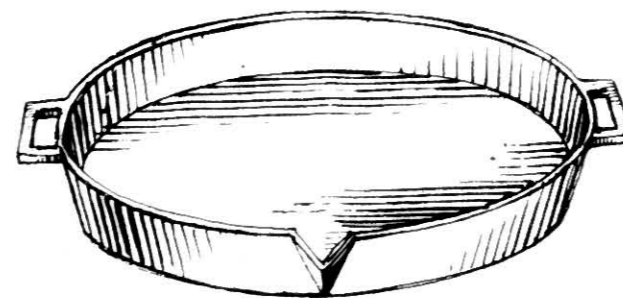

8 to 18 inches, rising 1 inch.

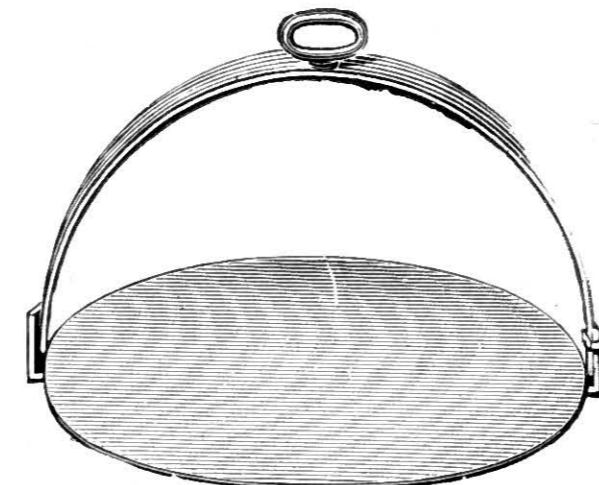

GIRDLES, with Cast-on Ears.  
GIRDLES, with Bow, Bow and Swivel  
or Folding Bow and Swivel Handles.  
3/8 inch thick, 11 to 21 inches, rising 1 inch.  
1/2 inch thick, 11 to 24 inches, rising 1 inch.

Prices on application.